

Max Compact Exterior Technical Details

Issue: August 2023

For you to create

www.fundermax.com

Fundermax

**“Creativity needs to be
outwardly appealing.”**

(Hannes K., architect)





Contents

Products	4
Sustainability and the Environment	12
Cleaning	16
Processing Recommendations	18
Facades	30
Invisible Glued Fastening	44
Invisible Mechanical Fastening	52
Soffits	68
Outdoor Furniture	74
Balconies and Railings	78
Podio Balcony Floor Panels	92
Roof Coverings	102
Sun Protection	108
Suppliers and Components	114

Notes

Current version of this brochure:
www.fundermax.com

The diagrams in this brochure are schematic representations and are not true to scale.

This issue replaces all previously published issues of Max Compact Exterior Technical Details from Fundermax.

If you have any questions that this brochure does not answer, please contact our sales team or application engineers at support@fundermax.biz. We will be happy to help you.

Fundermax

From furniture and facades to interior design, Fundermax is at the interface of ideas and materials. Today the company – which has a proud history spanning 130 years – stands as a global market leader and producer of high quality materials using wood and laminates. Our lasting success has been based on high quality, imaginative design, diversity and sustainable production. Our products are “Made in Austria” and exude a love for the natural resources of wood, creativity and inventiveness.

- modern production facilities in Austria and Norway
- approx. 1,500 employees
- annual turnover of €500 million
- part of Constantia Industries AG
- The Austrian Excellence Award (2018)

1 Products

“Only good ideas and good products are really durable.”

(Isabelle S., project manager)





HERNANDEZ 24

Max Compact Exterior

These panels are thermoset high-pressure laminates (HPL) that meet the requirements of EN 438-6, type EDF, and are produced in laminate compactors at a high temperature and pressure. Dual-cure acrylic polyurethane resin ensures highly effective weather protection—ideal for long-lasting balcony and facade cladding.

Properties*

- dual-cure
- suitable for all outdoor applications
- weatherproof (EN ISO 4892-2)
- lightfast (EN ISO 4892-3)
- bending resistant (EN ISO 178)
- impact resistant (EN ISO 178)
- scratch resistant
- solvent resistant
- hailproof
- frost and heat resistant
- continuous temperature load -80°C to $+80^{\circ}\text{C}$
- easy to install and clean
- decorative

* Standard and actual values: www.fundermax.com

Designs

Max Compact Exterior F-Quality:

These panels come with decorative laminate on both sides, a flame-retardant core, and lightfast and weather-proof surfaces as standard (Fire Test EN 13501-1, B-s2, d0).

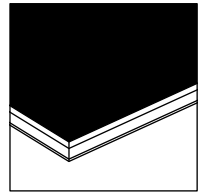

Composite elements:

To make composite elements, F-Quality panels can also be supplied with one smooth side.

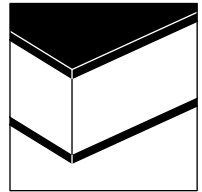

Max Compact Exterior elements:

Fundermax offers panel cutting and CNC machining – from drilling simple holes for attaching facade panels to complex milling for balcony components.



Professional Advice

Our services are designed to help you use our products more effectively. For example, you can benefit from free architectural advice and our extensive range of system solutions. We can also help if you have any questions about the information in this brochure or about decorative panels and technology.

Max Compact Exterior F-Quality

A high-quality construction product bearing the CE label for use as durable balcony and facade cladding. The panels feature thermoset high-pressure laminates (HPL) that meet the requirements of EN 438-6, type EDF, with the most effective weather protection thanks to dual-cure acrylic polyurethane resin.

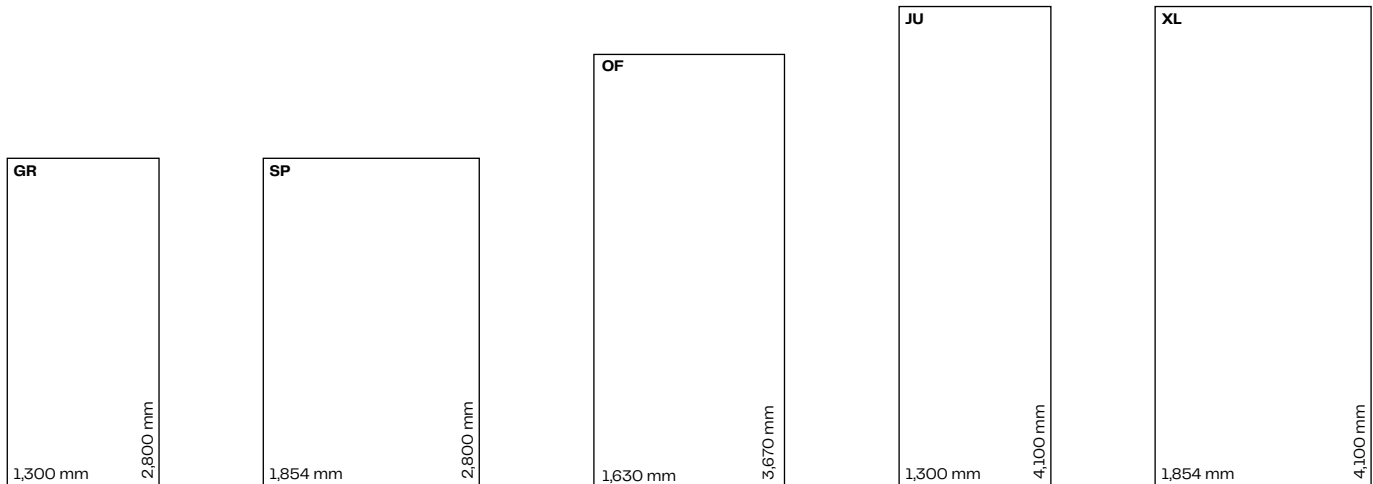

Surfaces

- NT
- NH (Hexa)/NT
(only for sizes 4,100 x 1,854 mm, 2,050 x 1,854 mm, and 2,800 x 1,300 mm)
- NG* (Gloss)/NG (Gloss)
(only for size 4,100 x 1,300 mm)
- NY (Sky)/NT
(only for size 4,100 x 1,300 mm, thicknesses of 6.0 and 8.0 mm, limited range of decorative finishes)
- NP (Paragon)/NT

Sizes**

- 2,800 x 1,300 mm = 3.65 m²
- 4,100 x 1,300 mm = 5.33 m²
- 3,670 x 1,630 mm = 5.98 m²
- 2,800 x 1,854 mm = 5.19 m²
- 4,100 x 1,854 mm = 7.60 m²

Thicknesses

Panels with decorative laminate on both sides:

Thickness	Tolerance (EN 438-6, 5.3)
• 2.0–2.9 mm	±0.2 mm
• 3.0–4.9 mm	±0.3 mm
• 5.0–7.9 mm	±0.4 mm
• 8.0–11.9 mm	±0.5 mm
• 12.0–13.0 mm	±0.6 mm

Panels with the Hexa surface:

Thickness	Tolerance (EN 438-6, 5.3)
• 6.0–7.9 mm	±0.4 mm
• 8.0–11.9 mm	±0.5 mm
• 12.0–15.9 mm	±0.6 mm
• 16.0–20.0 mm	±0.7 mm

Panels with smooth reverse side (for symmetrical sandwich elements):

Thickness	Tolerance (EN 438-6, 5.3)
• 2.0–2.9 mm	±0.2 mm
• 3.0–4.0 mm	±0.3 mm

Core

- F-Quality
- flame retardant
- Brown color

1 01 Composition of Max Compact Exterior panels

1 01

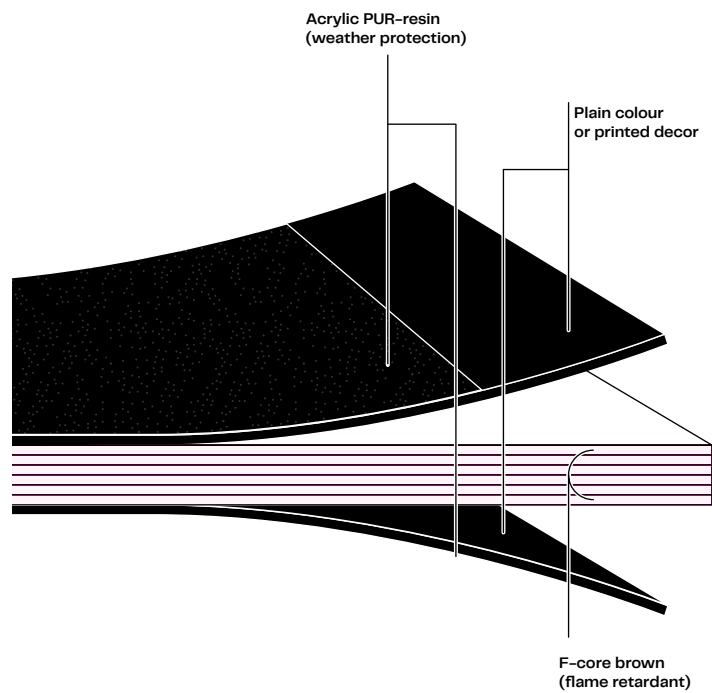
**Tip**

For a consistently light design for balcony interiors, Max Compact Exterior panels can also be made with a white (reverse) side (0890 NT – Balkonweiss). The combination of different decorative laminates means the specified mounting distances should be reduced by at least 15%.

* For the best possible facade cladding look, installation using adhesive on an aluminum substructure is recommended. Timber is advised against, as an uneven surface can lead to a wavy appearance.

** Panel sizes with tolerances of +10.0–0.0 mm (EN 438–6, 5.3) are standard sizes—if absolute size and angle precision is required, cutting around all sides is recommended. Depending on the cut, the net measurement reduces by approx. 10.0 mm.

Max Compact Exterior—Physical Data and Approvals

Properties	Testing methods	Assessment	Standard value ¹⁾	Typical value ²⁾
Lightfastness and weather resistance (NT)				
Resistance to artificial weathering*	EN 438-2:2016, Section 29, 3,000 h	Contrast: Gray scale Appearance: Degree	Contrast: ≥ 3 Appearance: ≥ 4	Contrast: 4–5 Appearance: 5
Resistance to UV rays*	EN 438-2:2016, Section 28	Contrast: Gray scale Appearance: Degree	Contrast: ≥ 3 Appearance: ≥ 4	Contrast: 4–5 Appearance: 5
Properties				
Mechanical properties				
Bulk density	DIN 52328 / EN ISO 1183	g/cm ³	≥ 1.35	1.44
Flexural strength	EN ISO 178	MPa	≥ 80	Crosswise: 105 Lengthwise: 170
E-modulus	EN ISO 178	MPa	$\geq 9,000$	Crosswise: 11,000 Lengthwise: 16,000
Tensile strength	EN ISO 527-2	MPa	-	Crosswise: 95 Lengthwise: 140
Resistance to impact with a large ball	EN 438-2:2016, Section 21	mm	≤ 10	5–6
Thermal properties				
Resistance to moisture	EN 438-2:2016, Section 15	%	Mass increase: ≤ 8	2
Dimensional tolerance at high temperature	EN 438-2:2016, Section 17	%	Lengthwise: ≤ 0.30 Crosswise: ≤ 0.60	Lengthwise: 0.08 Crosswise: 0.16
Coefficient of thermal expansion	DIN 52328	1/K		18 x 10 ⁻⁶
Thermal conductivity		W/mK		0.3
Resistance to vapor diffusion				approx. 17,200 μ
Building material classes				
Europe building material class	EN 13501-1	MA39-VFA Vienna	Euroclass B-s2, d0 for 6–13 mm**	
Austria facade fire testing	ÖNORM B 3800-5	MA39-VFA Vienna	Panel thicknesses tested 8–13 mm	
Austria fire resistance testing of balcony floor panels	EN 1365-2	MA39-VFA Vienna	REI60 for panel thickness of 20 mm	
Switzerland building material class	EN 13501-1	MA39-VFA Vienna	Euroclass B-s2, d0 for 6–13 mm ²⁾	
France building material class	NFP 92501	LNE	M1 for 2–10 mm	
Spain building material class	UNE 23727-90	LICOF	M1 for 6–10 mm	
Poland building material class	PN-B-02867:2013-06	Instytut Techniki Budowlanej	NRO for 6–0 mm visible/invisible mechanical fastening NRO for 8–10 mm invisibly glued	
Approvals				
Germany facade approval		Deutsches Institut für Bautechnik, Berlin	6, 8, 10 mm, Approval no. Z-10.3-712	
ETB guidelines for components that protect against falling, from 6/1985 balcony railings		TU Hanover	present (depending on building regulations and railing construction, 6, 8, 10, or 13 mm panel thickness)	
France Avis technique		CSTB	6, 8, 10, and 13 mm, timber and metal substructure, approval no. 36-87 2/16-1749 no. 36-106 2.2/14-1623_V1 no. 36-125 2.2/13-1565_V2 no. 36-125 2.2/21-1809_V1 no. 36-125 2.2/16-1716 no. 36-29 ATT-20/O13_V1 no. 26-29 ATT-20/O14_V1	
WinMark UK		Wintech	A10114	

1) In accordance with EN 438-6

2) Typical values are given as examples only and cannot be used for any liability on the part of Fundermax (they are not confirmed, guaranteed values). Fundermax only guarantees compliance with standard values.

* Custom decorative printing: Artificial weathering EN ISO 4892-2: 3,000 h; Assessed based on the gray scale EN 20105-A02: 3

** The exception is the Podio balcony floor panel, Euroclass B-s2, d0 (6.0–20.0 mm).

For the NT surface, a gloss level tolerance of ± 5 GE is measured at 60° . With regard to color tolerance, the ÖFHF Tolerances data sheet applies (version dated 16 January 2017; www.oefhf.at).

Other and up-to-date tests and approvals can be found in the Downloads section at www.fundermax.com.

Legal notes:

Please take into account any currently valid building regulations; we accept no liability in this regard.

Please check whether your construction project complies with the requirements to effectively restrict the spread of fire (e.g., OIB-RL 2, German draft administrative regulation for technical building regulations (MVV TB), etc.). This brochure is intended for specialists who are trusted to adhere to the relevant standards, technical regulations, legal requirements, and guidelines relating to building products.

The rules have been painstakingly revised. However, we would like to point out that responsibility for proper planning lies with the planner, and responsibility for correct installation lies with the contractor.

2 Sustainability and the Environment

**“I want my work to leave a mark—
but it should be sustainable.”**

(Henrik T., entrepreneur)

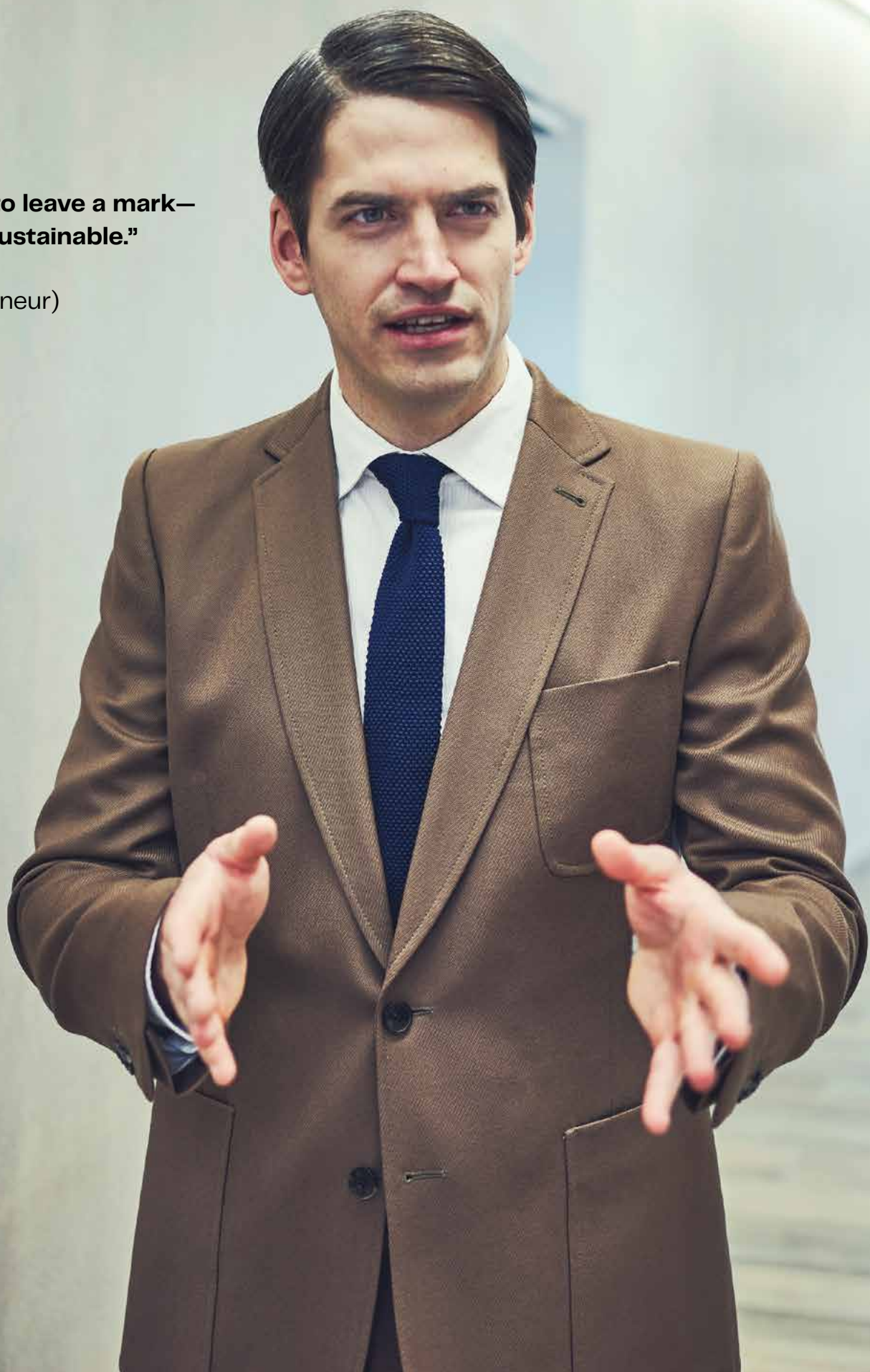



Sustainability at the Company

Fundermax is a specialist in processing renewable raw materials—and has been for over 130 years. This involves closed production cycles, material remnants being returned to the production process, and energy recovery in green power district heating plants. This allows Fundermax to supply district heating to over 8,500 households.

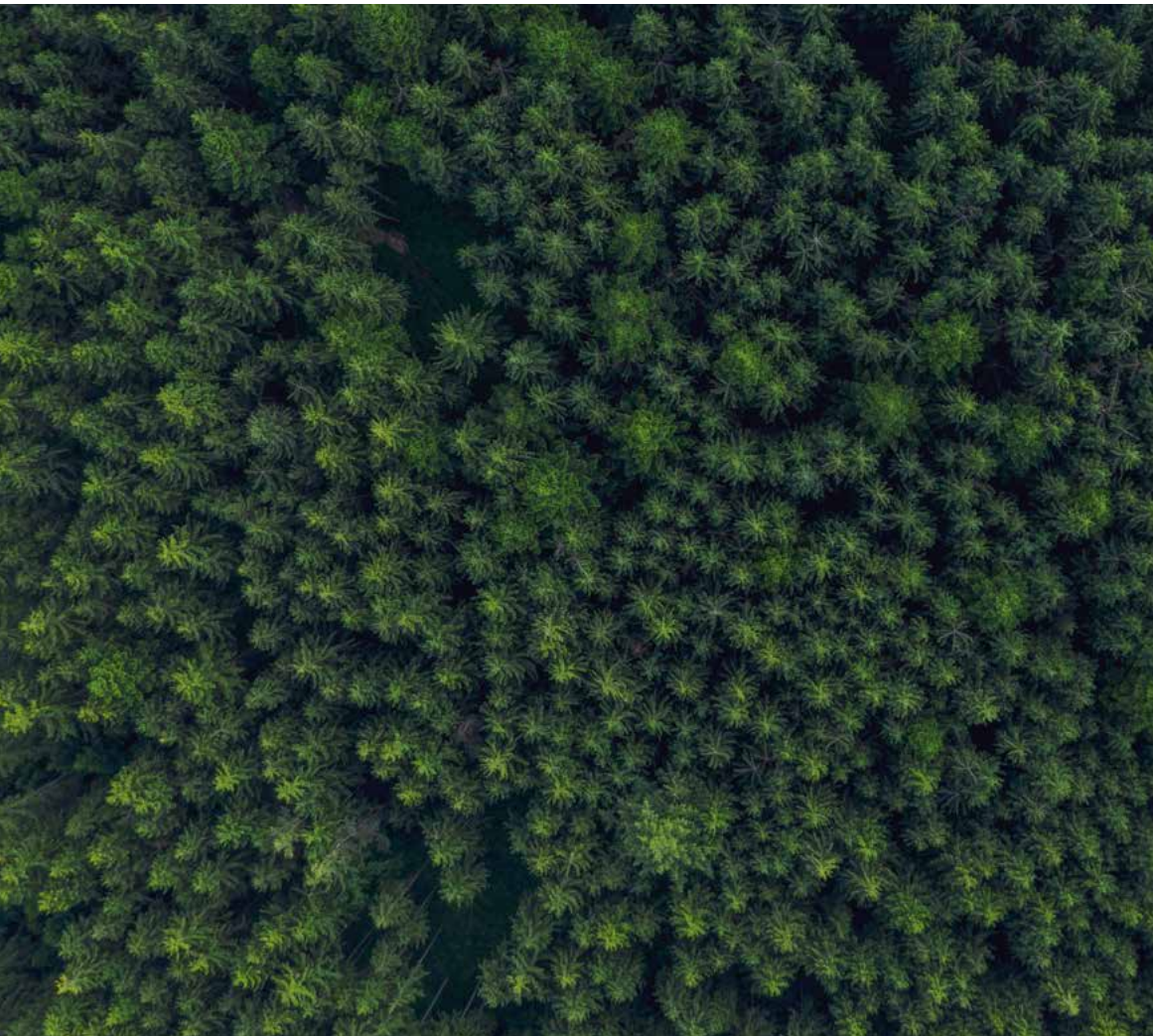

Quality Management

The production facilities and processes comply with internationally recognized standards (ISO 9001, ISO 14001, ISO 50001, ISO 45001). Fundermax's process of procuring raw and primary materials also follows current standards such as FSC® C101966 and PEFC™ (details: www.fundermax.com).

Sustainable Production

Max Compact Exterior panels consist of natural fiber panels (about 65% of the total weight) and are made mainly of wood, which is processed into kraft paper. This wood is a by-product from lumber production or in sawmills. The raw materials come from suppliers certified to the FSC® C101966 and PEFC™ standards, which guarantee sustainable forest management.

The kraft paper is impregnated with synthetic resins in impregnation plants, then dried and pressed into panels at a high pressure and temperature. They do not contain any organic halogen compounds, asbestos, wood preservatives (fungicides, pesticides, etc.), sulfur, mercury, or cadmium.

The exhaust air extracted during drying is treated using regenerative thermal oxidation. The heat generated from this is returned to the process, saving around 10,000 tons of CO₂ annually. This exhaust air treatment has also received the "klimaaktiv" award from the Austria Energy Agency and the Federal Ministry for the Environment.

Waste Disposal

When Max Compact Exterior panels are cut and milled, they produce chips. These can be disposed of thermally, in modern heating systems, without emitting hydrochloric acid, organic chlorine compounds, or dioxins. Max Compact Exterior decomposes into nothing but carbon dioxide, nitrogen, water, and ash. The resulting energy is used for district heating, for example. Disposal at commercial landfills is no problem either—country-specific laws and regulations apply.

3 Cleaning



“Flawlessness is the most beautiful goal.”

(Matteo V., architect)



Cleaning Process for Max Compact Exterior

For unknown stains:

Perform basic cleaning and, if necessary, cleaning steps 1 to 6 in order until the desired result is achieved. When cleaning with solvents, observe accident prevention regulations. No open flames!

Basic cleaning:

Clean surface just with hot water and a soft sponge, cloth, or brush (e.g., nylon brush)—DO NOT scrub!

Step 1:

Clean the surface with clean, hot water using a sponge (don't use the rough side), cloth, or soft brush—DO NOT scrub!

Step 2:

If that doesn't remove the stain, use a cleaning product that doesn't contain any abrasive ingredients (e.g., dishwashing liquid, glass cleaner). Carry out final cleaning.

Step 3:

If the stain persists, a soap-based solution (1:3) can be used. Give it more time to take effect depending on the degree of soiling. Carry out final cleaning.

Step 4:

Same as step 1, but using organic solvents (e.g., acetone, alcohol, nitro thinner, turpentine). Remove deeper stains mechanically. Caution: Avoid scratches by using a plastic or wooden spatula. Carry out final cleaning.

Step 5:

For adhesive, varnish, sealant, and silicone residue: Wipe the surface with a dry soft cloth or sponge. If the stain persists, use silicone remover or a cleaning product recommended by the adhesive manufacturer. Please note: Hardened 2-part adhesive, 2-part varnish, 2-part foam, or 2-part sealant CANNOT be removed!

Step 6:

In the case of extremely persistent lime contamination, acidic cleaning agents (e.g., 10% acetic or citric acid) can also be used. Carry out final cleaning.

Final cleaning:

Remove all traces of the cleaning product to prevent smears. Lastly, rinse with clean water. Dry the surface with an absorbent cloth or paper towel.

4 Processing Recommendations

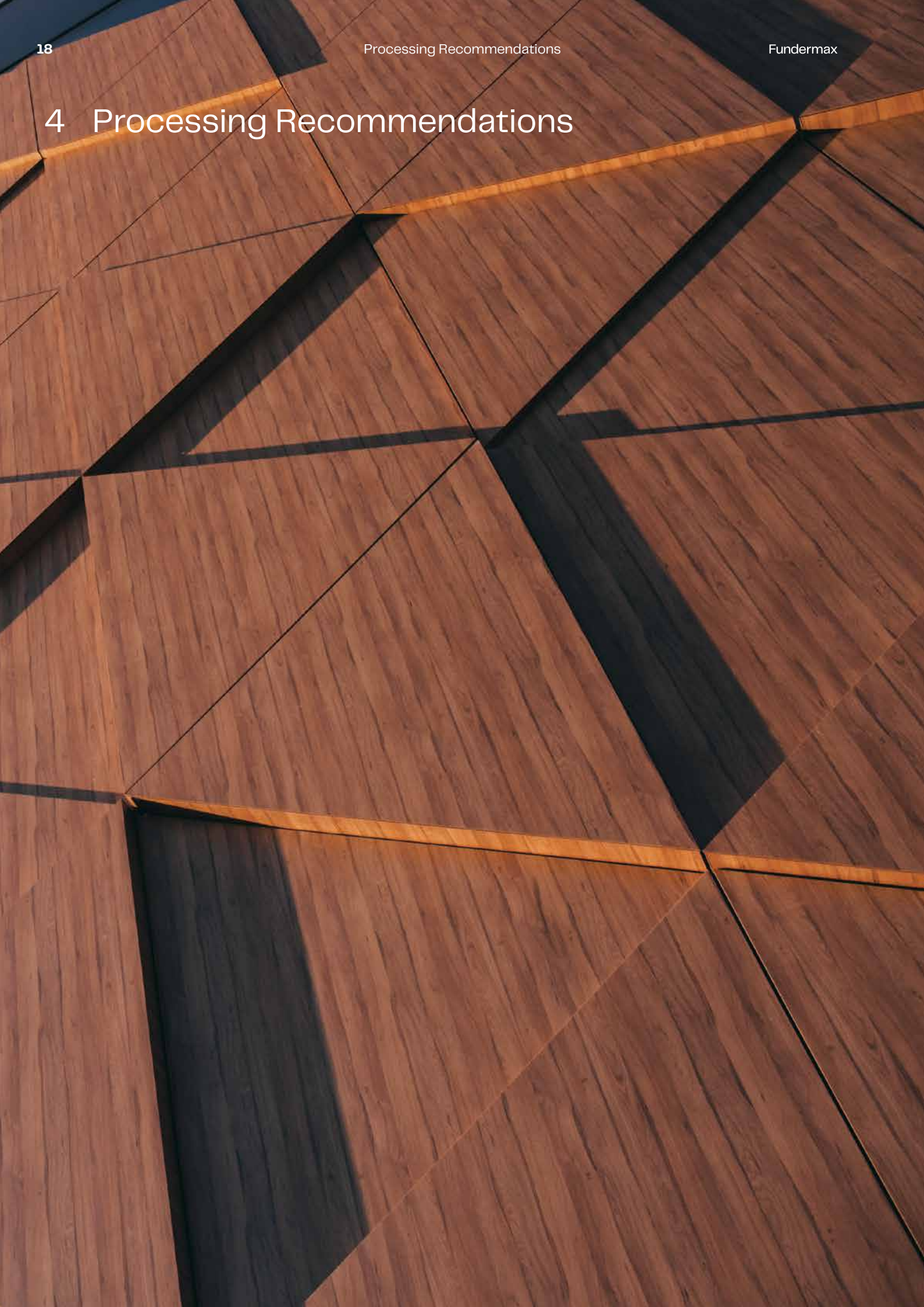

A man with dark, curly hair and a full beard is shown in profile, looking out of a window. He is wearing a light-colored, ribbed sweater. The background is a blurred view of a city street with buildings and trees.

**“Good products call for
good treatment.”**

(Jonas G., contractor)

Guidelines for Handling Max Compact Exterior

- 4 01 Handling Max Compact Exterior panels
- 4 02 Stacking and storing Max Compact Exterior panels
- 4 03 Short-term temporary storage
- 4 04 Storage of pre-assembled elements

Transport and Handling

Handle with care! Despite the surface hardness and transport protection film, the stack weight can cause damage. Therefore, it is important to avoid getting dirt or dust between the panels.

Secure the panels to prevent slipping during transport and lift them during loading and unloading—do not pull or push them over the edge (see Fig. 4 01)!

Always remove transport protection film from both sides at the same time. Leaving the protection film on one side may cause the panel to warp. Increased adhesion of the film may occur after storage, requiring more force to remove it. This does not affect the quality of the product and is not a reason for complaint. Do not expose the film to direct sunlight or heat.

Installation

Appropriate protective equipment (protective gloves, helmet, etc.) must be used while handling and installing the facade panels. Gloves must be clean and free from abrasive anti-slip coatings to avoid staining or damaging the surfaces.

Storage and Air Conditioning

Max Compact Exterior panels must be left in their original packaging. They should be stacked horizontally on a flat, stable, and padded surface. If necessary, they can be stored for a short time as shown in Fig. 4 03. The panels must lie completely flat. After removal, the original packaging should be closed again.

Cover plates must always be left on the stack (see Fig. 4 02). The top cover should be weighted down—this also applies to stacks with cut panels.

Incorrect storage will cause permanent deformation of the panels. Max Compact Exterior panels should be stored in enclosed spaces, under normal climatic conditions (15°C to 25°C, with relative humidity at 40–60%). Avoid exposing the two surfaces to different climatic conditions.

In the case of pre-fitted fastening elements, make sure the climatic influence is the same from all sides. Use intermediate layers of wood or plastic (see Fig. 4 04).

Final Cleaning

Foreign substances (e.g., drilling and machine oils, greases, adhesive residues, etc.) that soil the surface of the Max Compact Exterior panels during storage, installation, and use must be removed immediately without leaving any residue. We recommend using oil-free sunscreen (e.g., Physioderm Physio UV 50 Spray), since it is often not possible to remove conventional sunscreens completely. If these recommendations are not observed, we cannot accept responsibility for any complaints regarding color, gloss, or surface. For the best possible appearance, regular cleaning is recommended. Please also note our cleaning steps on page 17.

4 01

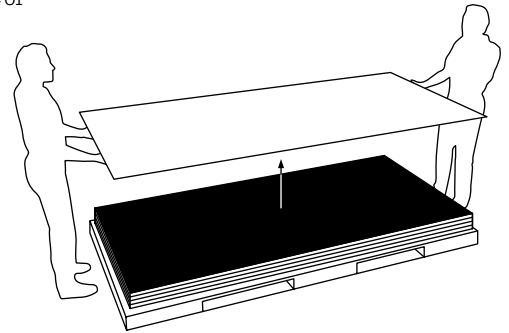

4 02

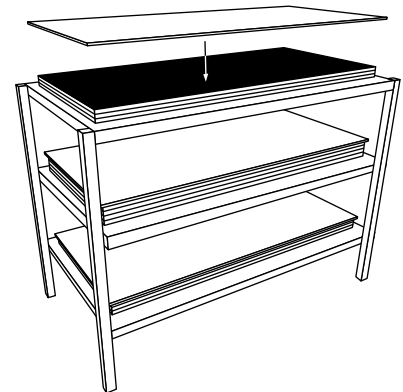

4 03

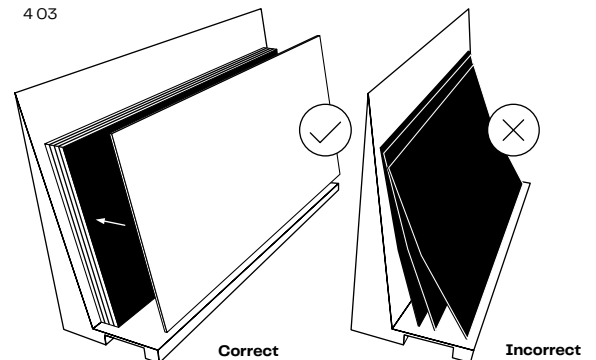

4 04

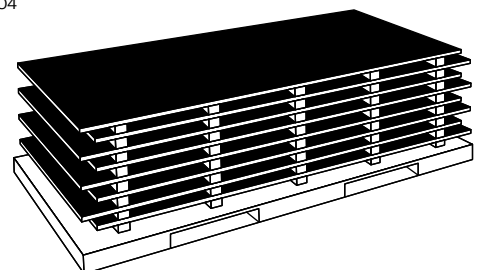

Working with Max Compact Exterior

General

Panel surfaces made out of dual-cure acrylic polyurethane resin are extremely durable. The processing properties are similar to those for processing hardwood. Tools with tungsten carbide blades are essential. Use tools equipped with diamond tips (PCD) to make them last. To prevent chipping, splintering, and flaking of the decorative side, using sharp-bladed tools that function smoothly is a must. To protect the surface and prevent chips from becoming lodged, machine tables should be smooth and have as few joints as possible. This also applies to workbenches and using handheld machines.

Safety Measures

This is simply a list of recommended personal protective equipment (PPE). The protective equipment required to ensure the safety of the respective activity must be used (work clothes, safety boots, hairnets, etc.).



Gloves:

Non-beveled cutting edges are sharp. You should use protection category II gloves with at least cut resistance 2.



Dust protection:

Processing these panels can create dust. Adequate respiratory protection (e.g., disposable fine dust mask) must be used.



Safety glasses:

When working with Max Compact Exterior panels, as with other wood-based materials, use eye protection that is as tightly sealed as possible.



Hearing protection:

The sound level can rise above 80 dB(A) during mechanical processing. Please always make sure you have adequate hearing protection!

EN 388		Mechanical risks	
The higher the number, the better the test result.			
4	1	2	1
Test criterion		Possible ratings	
Abrasion resistance		0-4	
Cut resistance		0-5	
Tear strength		0-4	
Puncture resistance		0-4	

General Processing Guidelines

When working with Max Compact Exterior panels, keep in mind the ratio between the number of teeth (z), the cutting speed (v_c), and the feed rate (v_f).

	vc m/s	fz mm
Sawing	40.0–60.0	0.02–0.1
Milling	30.0–50.0	0.3–0.5
Drilling	0.5–2.0	0.1–0.6

Calculating the Cutting Speed

$$v_c = D \cdot \pi \cdot n / 60$$

v_c – cutting speed [m/s]

D – tool diameter [m]

n – tool speed [min⁻¹]

Calculating the Feed Rate

$$v_f = f_z \cdot n \cdot z / 1,000$$

v_f – feed rate [m/min]

f_z – tooth feed

n – tool speed [min⁻¹]

z – number of teeth

Cutting Material

Tools with tungsten carbide blades (HW – Leitz) can be used. Using tools with polycrystalline diamond (PCD) blades is recommended to extend their service life.

General Notes

If chips are not regularly removed, this can quickly lead to the blade becoming damaged. The motor power required increases and the service life of the tool is shortened. If the shavings are too small, the tool will scrape and quickly become dull. That means it will have a shorter service life.

For single cuts, prevent the panel from vibrating by working with used panels. The stack height depends on the machine power.

Tooth Shapes

TR/TR (trapezoid tooth/trapezoid tooth):

For cutting hard, abrasive laminates

HZ/DZ (concave tooth/pointed tooth):

For very good cutting and edge quality

at the top and at the bottom on machines without a scoring unit

FZ/TR (flat tooth/trapezoid tooth):

For working with Max Compact Exterior panels

WZ/FA (variable tooth with bevel):

Alternative to flat tooth/trapezoid tooth shape

HZ/FA (concave tooth with bevel):

Application similar to HZ/DZ, but with longer

tool life on machines without a scoring unit

- 4 05 TR/TR
- 4 06 HZ/DZ
- 4 07 FZ/TR
- 4 08 WZ/FA
- 4 09 HZ/FA

4 05

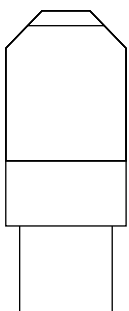

4 06

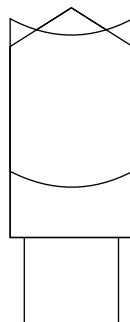

4 07

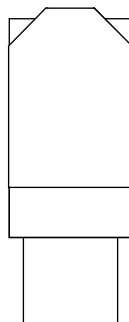

4 08



4 09

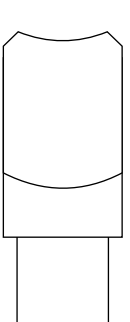

Cutting

4 10

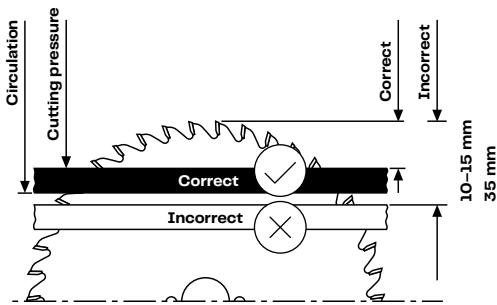

Vertical Panel Splitting, Table, and Sliding Table Saws without Scoring Unit

For circular saw blades with positive rake angle and saw shaft under the workpiece. Due to the positive rake angle, the cutting pressure takes effect using the stable table support (see Fig. 4 10).

4 11

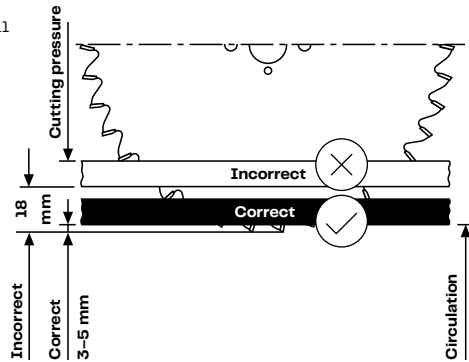

For circular saw blades with negative rake angle and saw shaft above the workpiece. Due to the negative rake angle, the cutting pressure takes effect using the stable table support (see Fig. 4 11).

Adjustment:

- Visible side up
- Very narrow saw guide
- Smooth alignment of the Max Compact Exterior panels on the workbench with the saw blade
- Correct blade protrusion

Depending on the blade protrusion, the entry and exit angles will change and thus the quality of the cutting edge. Upper cutting edge unclear: Raise the saw blade. Unclean cut on the underside: Lower the saw blade. This is how to find the most favorable height setting.

4 12

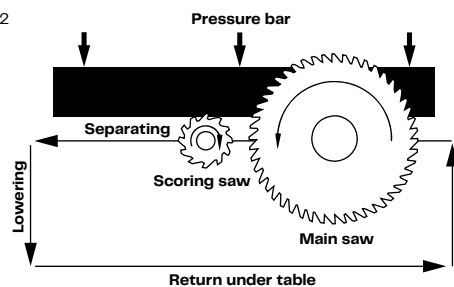

Sliding Table Saws and Panel Splitting Machines with Scoring Units and Pressure Bars

Scoring circular saw blades:

For good cutting edge quality on the tooth exit side, a scoring unit is recommended. Set the cutting width of the scoring circular saw blade to be slightly larger than that of the main circular saw blade so that the exiting tooth of the main saw no longer touches the cutting edge. Safe, flat support of the workpieces is only guaranteed with a pressure device. Use split scoring circular saw blades for table and sliding table saws. Panel splitting machine with scoring unit and pressure device. Operating diagram of the conical scoring circular saw blade. For maintenance of the tools (always in sets), the cutting widths (SB) must be aligned with one another.

4 13

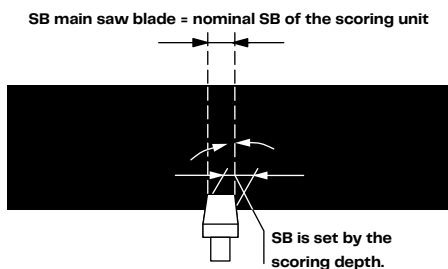

Cutting with Handheld Tools

Finely toothed hand saws are suitable for individual cuts. Slightly slanted teeth are preferable. Saw from the surface of the panel, and pass through at an angle (approx. 30°).

For straight cuts with handheld circular saws, use a stop bar or guide rail. Use tungsten carbide-tipped saw blades. The sawing is carried out from the underside of the panel, with the following tooth shapes:

- WZ (variable tooth) for coarse cuts
- FZ/TR (flat tooth/trapezoid tooth) for clean cuts of Max Compact Exterior and panels glued on both sides

Milling—Edge Processing

Edge Processing by Hand

Files are suitable for edge processing. The filing direction goes from the decorative side toward the core. Fine files, plane files, sandpaper (100–150 grain), or scrapers are suitable for smoothing edges.

Edge Processing with Handheld Machines

To mill bevels, use electric hand planes with a bevel or miter groove. Hand routers are used for special tasks (e.g., recesses for wash basins, trax couplings, etc.) using tungsten carbide tools. To protect the Max Compact Exterior surface, cover the supporting surface of the hand router with parts of a different panel, for example. Don't use felt! Carefully remove milling shavings.

Milling tool diameter: 10.0–25.0 mm

Cutting speed v_c : 30.0–50.0 m/sec

We recommend using tungsten carbide-tipped milling cutters with indexable inserts. For better tool utilization, height-adjustable milling tools are preferable. Sharp edges are smoothed afterwards.

4 10 Circular saw blades with positive rake angle and saw shaft under the workpiece

4 11 Circular saw blades with negative rake angle and saw shaft above the workpiece

4 12 Sliding table saw with scoring unit

4 13 Operating diagram

Drilling

Solid carbide twist (VHW) or dowel drill bits are used for drilling. In machining centers, the use of the main spindle instead of the drilling beams at an rpm of 2,000–4,000 min⁻¹ and a feed rate of 1.5–3.0 m/min is recommended. Select the exit speed of the drill so that the melamine surface is not damaged. Shortly before the drill exits the workpiece in full diameter, the feed rate must be reduced by 50%. When drilling through-holes, the counter-pressure should be built up using hardwood or equivalent material to prevent the melamine surface breaking off.

Note for blind holes perpendicular to the panel plane:

- Pilot hole diameter (D) = Screw diameter minus approx. 1 channel depth
- Drilling depth (a) = Panel thickness minus 1.0–1.5 mm
- Screw-in depth = drilling depth minus 1.0 mm

Note for blind holes parallel to the panel plane:

- The residual thickness (b) of the Max Compact Exterior panel must be at least 3.0 mm.
- Select the diameter of holes parallel to the panel plane so that the panel does not split when screwing in the screws.
- For screwing in parallel to the panel plane, metal sheet and chip board screws are suitable.
- For stability: 25.0 mm minimum screw depth

Twist drills with a point angle of $\leq 90^\circ$ are especially suited to Max Compact Exterior panels. They have a large pitch with a large chip space. The steep tip means they are also suitable for drilling through-holes. They cut cleanly through the back of the material.

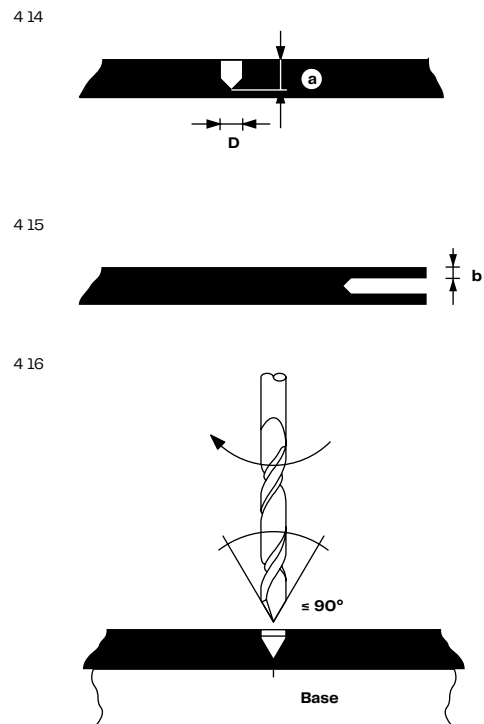

- 4 14 Screws perpendicular to the panel plane
- 4 15 Screws parallel to the panel plane
- 4 16 Twist drills with a point angle of $\leq 90^\circ$

Universal Drilling of Blind and Through-holes

Machines used:

- Point-to-Point drilling machines
- Through-feed drilling machines
- CNC machining centers
- Box column drills
- Inlet fitting drilling machines
- Drilling units
- Hand drills

Information about the drill:

- Flat roof drill bits
- Shank diameter identical to blade diameter
- Adaptable for shaft D 10 mm with reducing bush TB 110-O or PM 320-O-25.

Drilling

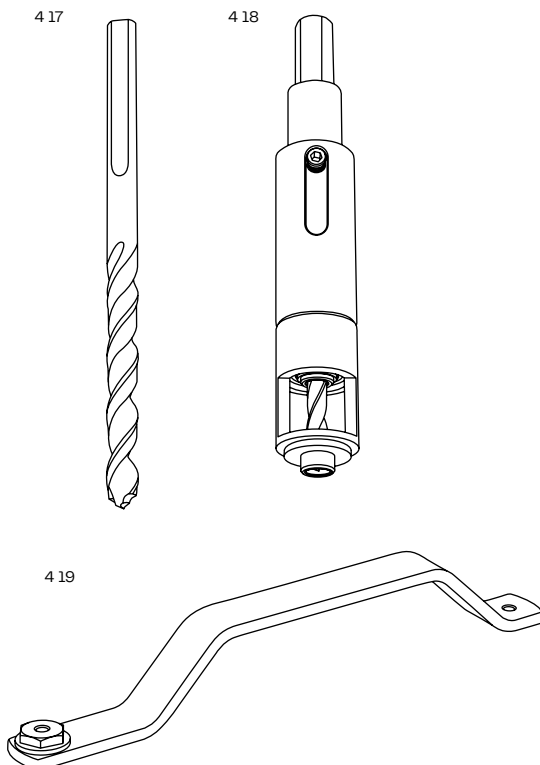

Blind holes

Especially suitable for drilling splinter-free blind holes in visible areas as well as for processing panel materials. Not suitable for drilling through-holes!

In the case of manual drilling, better guidance can be achieved by drilling a pilot hole. **Diamond drill bits are not suitable for Max Compact Exterior panels**

Machines used:

- Point-to-Point drilling machines
- Through-feed drilling machines
- Inlet fitting drilling machines
- Drilling units
- CNC machining centers

Information about the drill:

- Roughing geometry with extremely clean cut
- Solid tungsten carbide design with extremely wear-resistant tungsten carbide grade
- High stability and long service life
- Polished chip space for minimal friction and feed force

MBE solid carbide facade panel drill bit:

- MBE product number: 1360708 – 6.0 mm
- MBE product number: 1360702 – 8.0 mm
- MBE product number: 1360703 – 8.5 mm
- MBE product number: 1360704 – 10.0 mm

Pilot drill guide:

One-handed spring drilling jig

- MBE product number: 1360216 \varnothing 8.5 on 5.1 mm
- MBE product number: 1360215 \varnothing 10.0 on 5.1 mm

Bracket drilling jig

- MBE product number: 1360217 \varnothing 8.5 on 5.1 mm
- MBE product number: 1360218 \varnothing 10.0 on 5.1 mm

4 17 HSS drill bit 5.1 mm

4 18 One-handed spring drilling jig

4 19 Bracket drilling jig

Cutting and Milling Compact Panels— Suggestions for Resolving Processing Issues

Clamping Parts onto a Machine Table

There are two options for securing or clamping Max Compact Exterior panels onto a machine table, and one of these should be chosen depending on the type of processing. For both options, it is important to ensure that the suction cups are of an adequate size. If it is not sufficient, check the seals (e.g., sealing rings of the suction cups).

Securing by means of spaced-out suction cups:

In the case of milled panel parts or those with edge processing on both sides, it is recommended that they are secured using spaced-out suction cups. Take care to ensure the right spacing between the suction cups.

Securing by means of an MDF protective board:

In the case of milled panel parts and those with edge processing on one side, or those to be milled with holes or custom shapes, it is recommended that they are secured using an MDF protective board (can be used several times).

Spacing of the Suction Cups

To prevent the material from shaking and vibrating, the spacing of the suction cups and the edge of the panel that protrudes over the edge should be adapted to the thickness of the panel. The more suction cups and the smaller the distance from the protruding edge, the cleaner the milling pattern. As a rule of thumb, you can apply a maximum 300.0 mm grid to the area to be worked on, and the protruding edge of the panel should be no more than 30.0 mm. An MDF protective board (e.g., 19.0 mm thick) provides the best results because it ensures full-surface vacuum fixation on the Max Compact Exterior panel on the machine table.

Choice of Machining Tool

Max Compact Exterior panels can be machined with solid carbide (VHM) as well as diamond (PCD) milling tools. To ensure a clean milling pattern and a long service life, use vibration-free tool holders and spindles. You must also make sure the ball bearings are properly maintained! Diamond tools have proven particularly suitable for processing a large number of panels or a high number of running meters. Smooth-running milling cutters with a shank diameter of min. 10.0 mm in combination with straight continuous DIA cutting edges (2+1 blade) are especially suitable for format milling. Make sure that the feed rate and the cutting speed are adjusted for the specific job and cutter based on the material being processed. If necessary, raise the issue with the tool manufacturer.

Milling Tool Clamping Device

The positioning of the spindle in the chuck is crucial for ensuring the smooth running of the milling cutter. The more centered and play-free the milling cutter can be clamped in place, the better the result. Most machines are equipped with common tool holders (e.g., collets, hydro grips, or shrink chucks). For professional CNC machining for larger jobs, a hydro grip tool holder or shrink chuck is recommended (they guarantee the best tool clamping). Ensure proper maintenance of all moving parts (e.g., slide or ball bearings) to avoid vibrations in all axial directions.

Suction

The suction and suction capacity must be adjusted according to the material being processed to ensure that all the shavings are removed as effectively as possible. If the suction is not strong enough, there is a risk of heat being generated. This is due to shavings that remain between the cutter and the panel edge causing a high degree of friction, as the material cannot be ejected any further. This can potentially lead to burn marks on the edge of the panel.



CNC Machining by Fundermax

Fundermax has its own machining center, Compact Elements, where we offer CNC machining of Max Interior, Max Compact Exterior, Max HPL, and m.look panels. If this is something you are interested in, please contact our customer service center.

5 Facades



“Beautiful facades are like a positive first impression.”

(Lydia H., building developer)



Qualifications	32
Function and Advantages of Rainscreen Facades	32
Material Characteristics	34
Installing Max Compact Exterior Panels Using Rivets on an Aluminum Substructure	35
Invisible Glued Fastening Using an Adhesive System	44
Invisible Mechanical Fastening Using Plate Anchors	50
Invisible Mechanical Fastening	52
Important information about Rainscreen Facades on a Timber Substructure	56
Avoiding Errors with a Timber Substructure	58
Standards for Timber Construction	60
Installing Max Compact Exterior Panels Using Screws on a Timber Substructure	62

Qualifications

A:

Max Compact Exterior panels in thicknesses of 6.0–13.0 mm are EUROCLASS B–s2, d0 in accordance with EN 13501–1, and meet the requirements of ÖNORM B 3800–5 in the thicknesses 8.0–13.0 mm.

CH:

Max Compact Exterior panels in thicknesses of 6.0–13.0 mm are EUROCLASS B–s2, d0 in accordance with EN 13501–1.

D:

Max Compact Exterior panels in thicknesses of 6.0–10.0 mm are B–s2, d0 in accordance with EN 13501–1 and have general building regulation approval from the Deutsches Institut für Bautechnik, Berlin (approval number: Z–10.3–712).

F:

Max Compact Exterior panels in thicknesses of 2.0–10.0 mm are M1 in accordance with NFP 92501. The Avis Technique for timber and metal substructures can be found on page 10.



Notes

Up-to-date and more comprehensive documents on all standards and approvals regarding Max Compact Exterior can be found here:
www.fundermax.com

Function and Advantages of Rainscreen Facades

Insulation

The rainscreen facade system can be applied for various energy requirements with individually calculated insulation (insulation thickness). This will allow you to achieve the U-values needed for a low-energy building and meet the requirements of energy-saving regulations. The insulation works by storing as much heat as possible, balances out high summer temperatures in the interior, and minimizes CO₂ emissions (reduction in heat energy).

Preventing Condensation

Rainscreen facades cause an outwardly decreasing vapor diffusion resistance: Moisture caused by the structure or usage dissipates through the rear ventilation space. This ensures the insulation is sustainable and creates a pleasant interior climate.

Rain Protection

Rainscreen facades are part of stress group III according to the DIN 4108–3 standard and are resistant to driving rain. Moisture quickly dissipates in the rear ventilation space between the insulation and the cladding (weather protection).

Sound Insulation

Depending on the thickness of the insulation, the mass of the cladding, and the proportion of open joints, the sound reduction index can be increased by up to 14 dB.

Ecology—Sustainability

Minimizing CO₂ emissions: Environmental targets are achieved in new builds and renovations by using rainscreen facades, as measurable reductions in heat energy minimize the emission of carbon dioxide. Government and regional funding schemes for facade renovations to reduce energy consumption are available.

Economy

Cost-effectiveness due to a long life span, long maintenance intervals, and later return of the components into the material cycle.

Cost Security

Even in renovation projects, estimating the cost of a rainscreen facade is generally a case of precise cost planning.

Advantages of a Rainscreen Facade

- Precise facade cost estimate
- Installation process not dependent on weather
- Short, cost-efficient scaffolding time
- No disposal expenses during the installation phase
- Long maintenance intervals and low subsequent costs
- Long-term value retention and appreciation of the building

Construction Basics

Do not expose the material to any standing water—panels must be able to dry out. Bonded panels should always be joined in the same running direction. Max Compact Exterior panels may display variations in flatness (see EN 438-6, 5.3). This can be offset by stable, level construction of the substructure. All joints with other building elements or the subsurface should be securely closed. Avoid any flexible intermediate layers with the substructure, and between the parts of the substructure that have a tolerance of more than ± 0.5 mm. See the Tolerances data sheet (dated April 2020) from the ÖFHF.

Regional building regulations should always be observed.

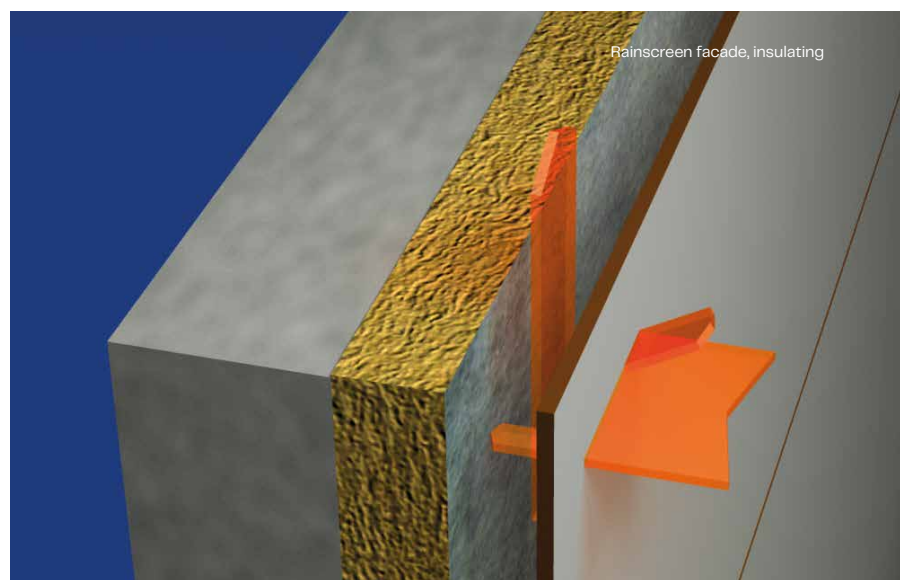
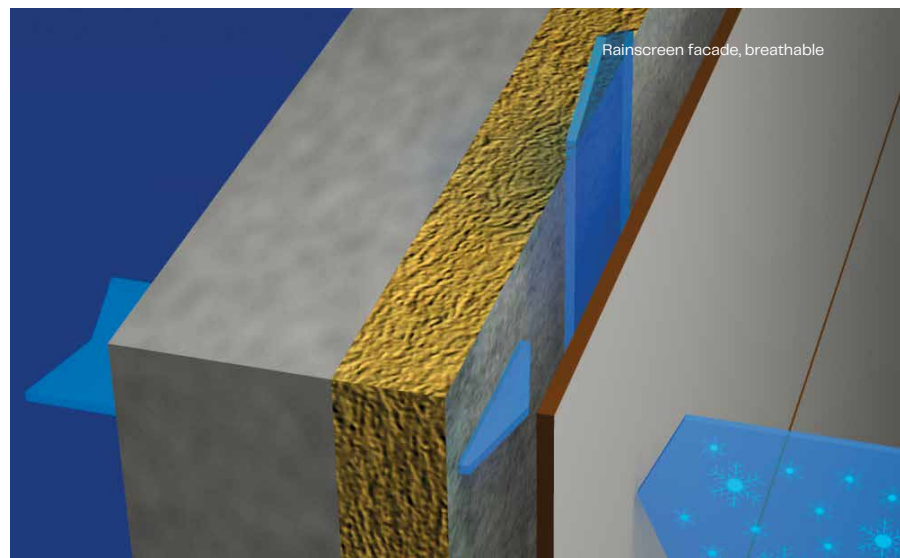

Material Characteristics

Max Compact Exterior shrinks when moisture is released and expands when moisture is absorbed. Any possible changes in size should be taken into account during machining and construction. This is basically about half as much lengthwise as crosswise.

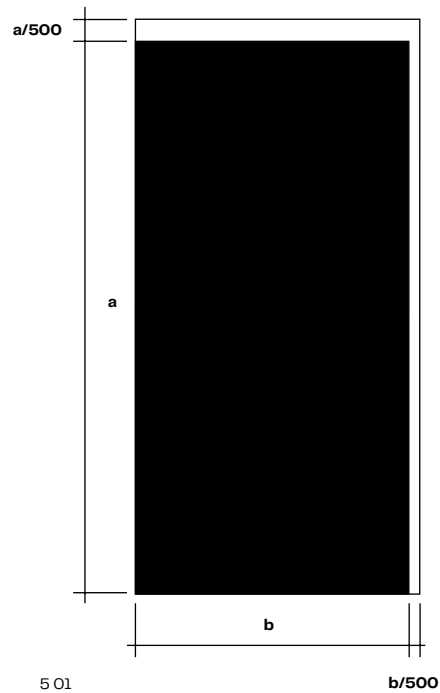

(see properties on page 10)
lengthwise related to nominal panel size.

Element length = a
Element width = b

a or b (in mm)/500 = expansion clearance

Installing Max Compact Exterior Panels Using Rivets on an Aluminum Substructure

Fasteners

Aluminum blind rivet with large head, color lacquered, for metal substructures

Rivet sleeve: Material no. EN AW-5019 according to DIN EN 755-2

Rivet pin: Material no. 1.4541

Pull-off strength of rivet pin: ≤ 5.6 kN

Drill hole diameter in the Max Compact Exterior panel:

- Sliding points: 8.5 mm or as required
- Fixed points: 5.1 mm
- Metal substructure: 5.1 mm

Substructure

Aluminum substructures must comply with national standards and be installed according to manufacturers' guidelines. Based on the material characteristics of Max Compact Exterior: Fasten using fixed (expansion) and sliding point fixings (see page 38, Fig. 5 08 and page 39, Fig. 5 09). The dimensions of metal substructures change according to changes in temperature, but the dimensions of Max Compact Exterior change under the influence of varying relative humidity. These dimensional changes of the substructure and cladding material can work in opposing directions. Therefore, it is important to ensure sufficient expansion clearance during installation.

Rear Ventilation Provisions

To avoid condensation building up in the rainscreen facade, always ensure proper ventilation. The clear vertical rear ventilation gap must be a minimum of $200.0 \text{ cm}^2/\text{m}$. For aluminum substructures, a clear minimum cross section of $150.0 \text{ cm}^2/\text{m}$ for air inlets and outlets is required (see DIN 18516:2010). To allow for vertical throughflow, arrange support frames vertically.

Notes

For suppliers of fasteners and substructures, see the end of the brochure or visit www.fundermax.com

5 02

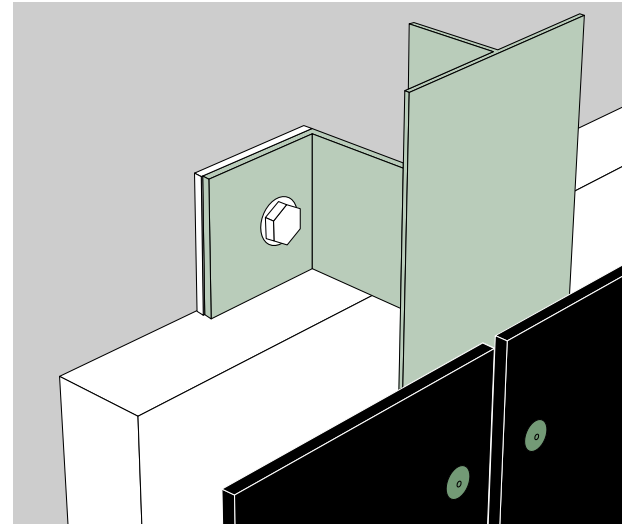

5 03

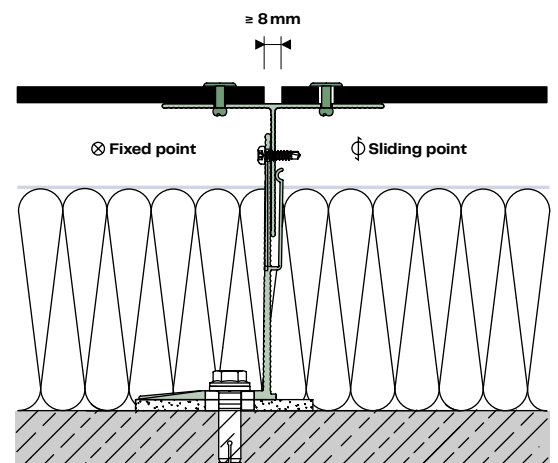

- 5 01** Dimensional change with moisture release or absorption
- 5 02** Installation using rivets
- 5 03** Example vertical joint

Forming Joints

To ensure that Max Compact Exterior panels can move without restriction, joints should be at least 8.0 mm. In Germany, this is set at 8.0 mm according to building regulation approval no. Z-10.3-712.

Fixed Point

Fixed points serve to evenly distribute (halve) changes in size. The drilling diameter for Max Compact Exterior panels is 5.1 mm. Instead of a fixed point hole, a fixed point sleeve can also be used.

One fixed point is required per panel. For panels arranged in groups, the fixed point should be positioned in the same place on all panels.

- MBE product number: 1240201 \varnothing 8.5 mm
- MBE product number: 1240205 \varnothing 10.0 mm



Fixed point sleeves

Expansion Point

As an option, an expansion point can be added to each panel. Alongside the fixed point, an expansion point serves to take the weight of the panel and is positioned at the same height as the fixed point. Changes in size are not restricted (see page 38, Fig. 5 08 and page 39, Fig. 5 09). To adjust and fix the expansion point sleeve, use the MBE driver tool in order to avoid any damage.

MBE product number: 1360603

MBE fixed point sleeve set plus, product no. 1240405, comprising:

- 100 Fixed point sleeves \varnothing 10.0 mm
- 100 Expansion point sleeves \varnothing 10.0 mm, slot 5.2 x 7.7 mm
- Drill hole tolerance: 10.0–10.03 mm



Expansion point sleeves

Notes

When using a fixed point sleeve with a diameter of 10.0 mm and an expansion point, the diameter of the head of the rivet should be at least 16.0 mm. Only one fixed point and one expansion point should be used per panel.

Sliding Point

The diameter of the drill hole in the Max Compact Exterior panel must be larger than the diameter of the fastener, depending on the required expansion clearance. The diameter of the drill hole is the shaft diameter of the fastener plus 2.0 mm per meter of cladding material starting from the fixed point.

The fastener head must cover the drill hole. Set fasteners so that the panel can move. Position rivets centrally using a flexible mouthpiece. The spacing between rivet heads on the surface of the panel (0.3 mm) allows for movement of the parts in the drill hole (see Fig. 5 05).

The center of the drill hole in the substructure should match the one on the Max Compact Exterior panel—use a drilling jig! Start fastening the panels at the center of the panel and work outward.

Rivets should be applied using a suitable special gauge attachment (allowance: 0.3 mm).

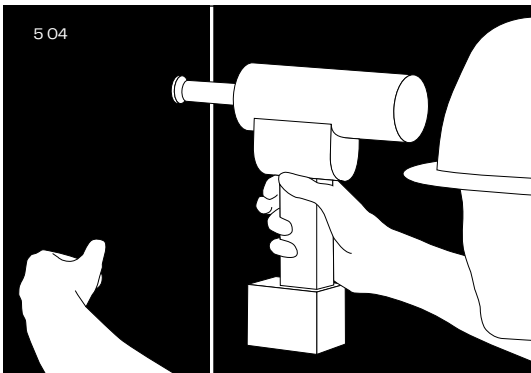

Notes

You'll find suitable rivets and rivet lengths on fastener manufacturers' websites (e.g., SFS or MBE).

For areas with special requirements (e.g., by the coast), there are specific fastener solutions from manufacturers (fastener type KS).

Curved shapes

Under force, Max Compact Exterior panels can be formed cold. The bend radii possible are associated with the thickness of the panel: the thinner the panel, the smaller the possible radius.

Fastening:

Fastening should be carried out mechanically. Choose spacing according to structural requirements. Panels must be supported by the pre-curved substructure. Careful workmanship is critical. Take note of the building regulations, recommendations, and notes in this brochure, and the appropriate number of fastenings.

Smallest possible bend radii without wind load:

- Panel thickness 6.0 mm: Radius 2,500.0 mm
- Panel thickness 8.0 mm: Radius 3,500.0 mm
- Panel thickness 10.0 mm: Radius 4,500.0 mm

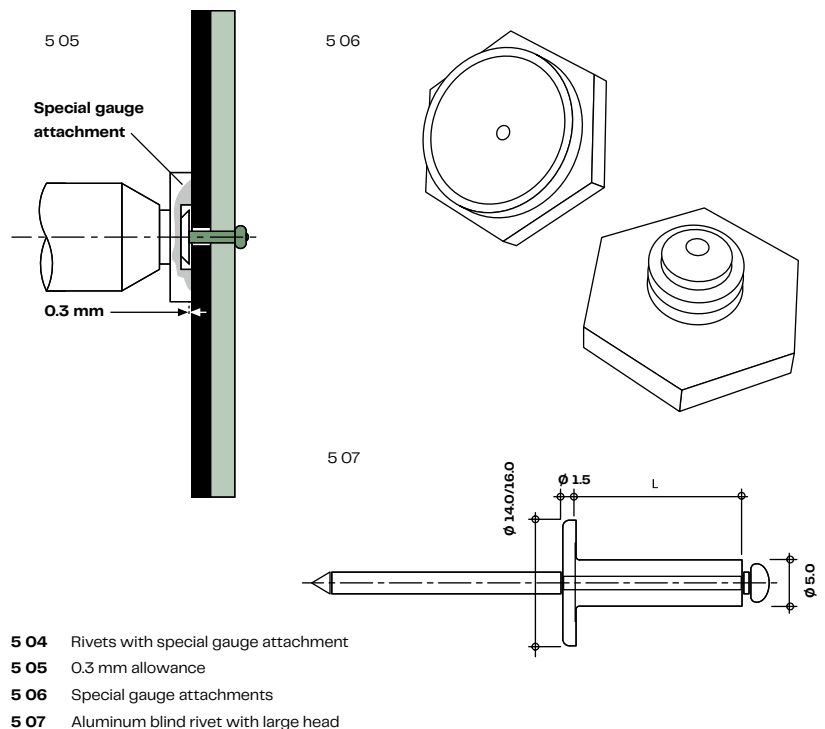

- 5 04 Rivets with special gauge attachment
- 5 05 0.3 mm allowance
- 5 06 Special gauge attachments
- 5 07 Aluminum blind rivet with large head

Fastener Spacing for Austria and Switzerland

If the axis "b" stated is not fully used, you can calculate the permissible fastener spacing "a" as follows (Source: Max Compact Exterior facade panel structural standard and Gerald Segeth, Dobel April 18, 2011):

Example for Austria:

When installing an 8.0 mm-thick single span panel and with a wind load of 0.5 kN/m²:

max. b = 970.0 mm

max. a = 649.0 mm

If "b" = 900.0 mm, for example, the maximum permissible value "a" is calculated as follows:

$$\text{perm a} = \frac{\text{max. b}}{\text{current b}} \times \text{max. a}$$

$$\text{perm a} = \frac{970.0 \text{ mm}}{900.0 \text{ mm}} \times 649.0 \text{ mm} = 699.0 \text{ mm}$$

5 08

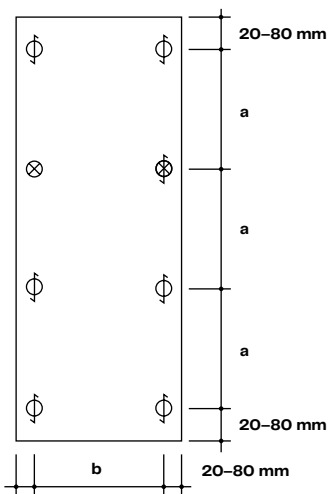

- ⊗ Fixed point
- ⊕ Sliding point
- ⊕ Expansion point

Load table for single span panels/wind load** Max Compact Exterior panels riveted onto aluminum substructure

Panel thickness	6.0 mm	8.0 mm	10.0 mm			
Load q (kN/m ²)	max. b (mm)	max. a (mm)	max. b (mm)	max. a (mm)	max. b (mm)	max. a (mm)

Germany*

0.50	600.0	600.0	700.0	700.0	800.0	800.0
1.00	600.0	431.0	700.0	539.0	800.0	551.0
1.50	600.0	311.0	700.0	373.0	800.0	455.0
2.00	537.0	261.0	700.0	280.0	800.0	337.0

Values refer to DIN 1055-T4 or DIN 18516 and approval Z-10.3-712.

Austria*

0.50	781.0	662.0	970.0	649.0	1,146.0	769.0
1.00	657.0	394.0	815.0	463.0	964.0	457.0
1.50	594.0	314.0	737.0	354.0	871.0	417.0
2.00	537.0	261.0	686.0	286.0	811.0	332.0

Values refer to ÖNORM B 4014-1,2 or EN 1991-1-4 and approval Z-10.3-712.

Switzerland*

0.50	781.0	662.0	970.0	649.0	1,429.0	470.0
1.00	657.0	394.0	815.0	463.0	1,201.0	279.0
1.50	594.0	314.0	737.0	354.0	1,033.0	217.0
2.00	537.0	261.0	686.0	286.0	894.0	188.0

Values refer to SIA standard 261 and approval Z-10.3-712.

5 08 Single span panel

5 09 Double span panel

Distance from Edge

Maintain a distance from the edge of 20.0–80.0 mm to ensure stability and flatness. For dimensional changes, ensure joints between panels are at least 8.0 mm (see Fig. 5 03, page 35).

Fastener Spacing

Observe relevant structural requirements. If this is not necessary due to local building regulations, consult the values in the table on page 38/39. Choose smaller fastener spacings on the edge of a structure than in the center (pressure, suction).

5 09

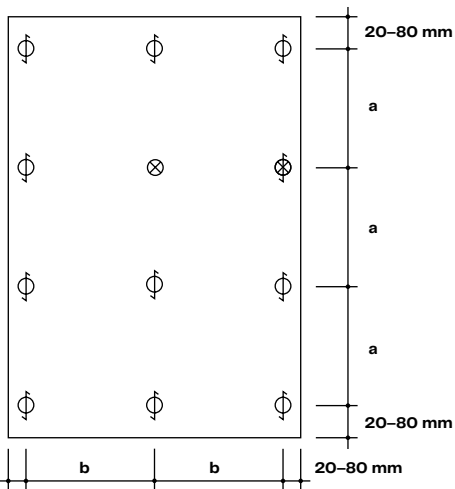

- ⊗ Fixed point
- ⊕ Sliding point
- ⊖ Expansion point

* Interpolation is possible based on this value.
 Example: In the case of non-utilization of the max. b value:
 Permissible $a = (\text{max } b / \text{current } b) \cdot \text{max. } a$
 Important: Permissible $a < \text{max. } a$

** Values in the calculation table are typical values. Tables for a wind load range of between 0.3 kN/m² and 2.6 kN/m² are available from the Fundermax support team on request.

Load table for double span panels/wind load** Max Compact Exterior panels riveted onto aluminum substructure

Panel thickness	6.0 mm	8.0 mm	10.0 mm
Load q (kN/m ²)	max. b (mm)	max. a (mm)	max. b (mm)
	max. a (mm)	max. b (mm)	max. a (mm)

Germany*

0.50	600.0	600.0	700.0	700.0	800.0	800.0
1.00	600.0	373.0	700.0	400.0	800.0	420.0
1.50	600.0	249.0	700.0	320.0	800.0	280.0
2.00	537.0	208.0	700.0	240.0	800.0	210.0

Values refer to DIN 1055-T4 or DIN 18516 and approval Z-10.3-712.

Austria*

0.50	974.0	425.0	1,209.0	417.0	1,429.0	420.0
1.00	759.0	295.0	1,012.0	276.0	1,201.0	279.0
1.50	620.0	241.0	826.0	271.0	1,033.0	217.0
2.00	537.0	208.0	716.0	235.0	894.0	188.0

Values refer to ÖNORM B 4014-1,2 or EN 1991-1-4 and approval Z-10.3-712.

Switzerland*

0.50	974.0	425.0	1,209.0	417.0	1,429.0	290.0
1.00	759.0	295.0	1,012.0	276.0	1,201.0	172.0
1.50	620.0	241.0	826.0	271.0	1,033.0	134.0
2.00	537.0	208.0	716.0	235.0	894.0	116.0

Values refer to SIA standard 261 and approval Z-10.3-712.

Construction Details—Horizontal Cross Section

Riveted Aluminum Substructure

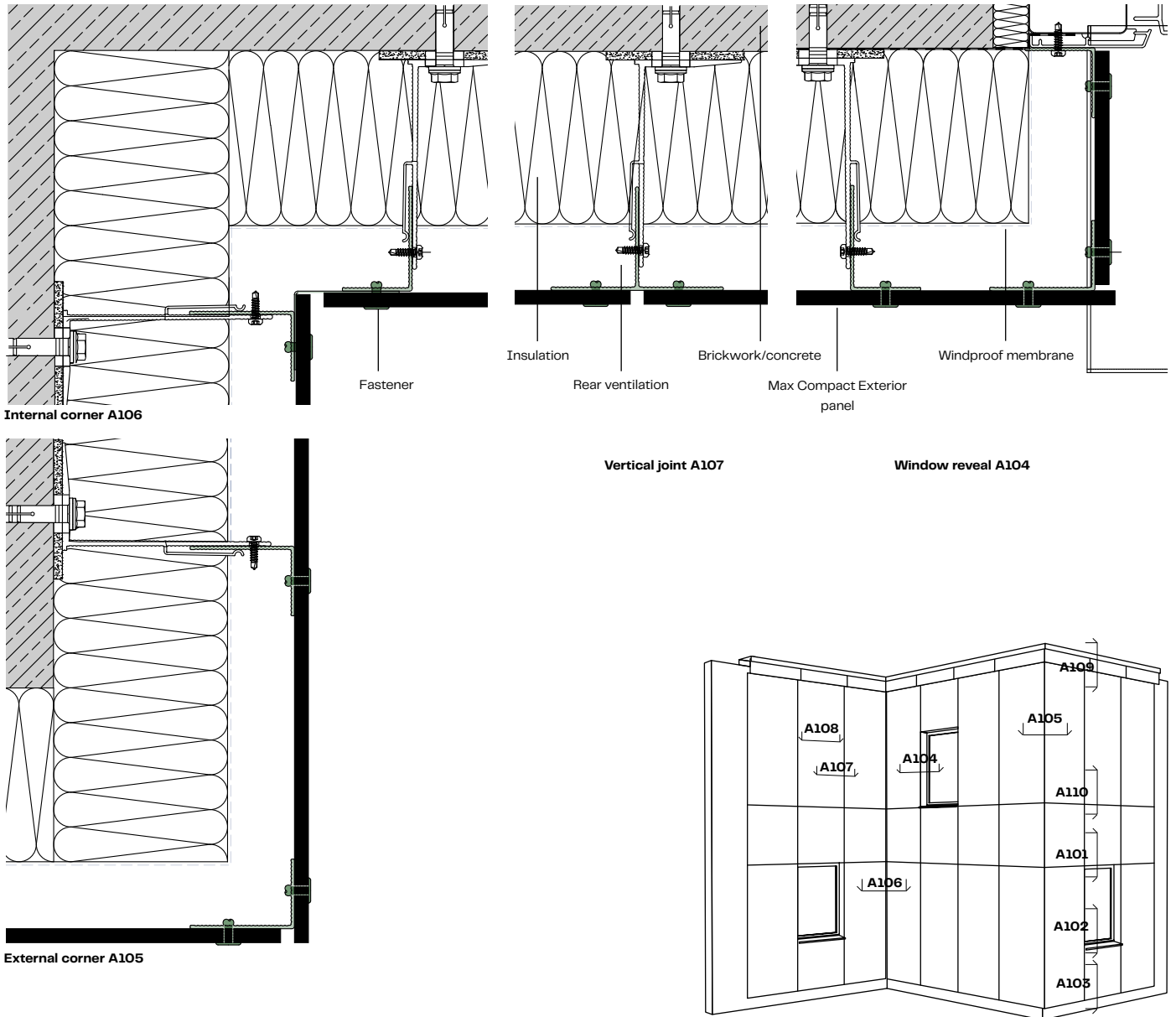

* The lintel design A101.2 was tested according to ÖNORM B 3800-5 and meets the requirements of OIB-RL 2 for building classes 4 and 5.

Note:
All of the profiles and fasteners shown in this brochure are suggestions for planning purposes and not part of Fundermax's scope of delivery. Drawings are NOT to scale.

Suppliers:
See end of the brochure.

Construction Details—Vertical Cross Section

Riveted Aluminum Substructure

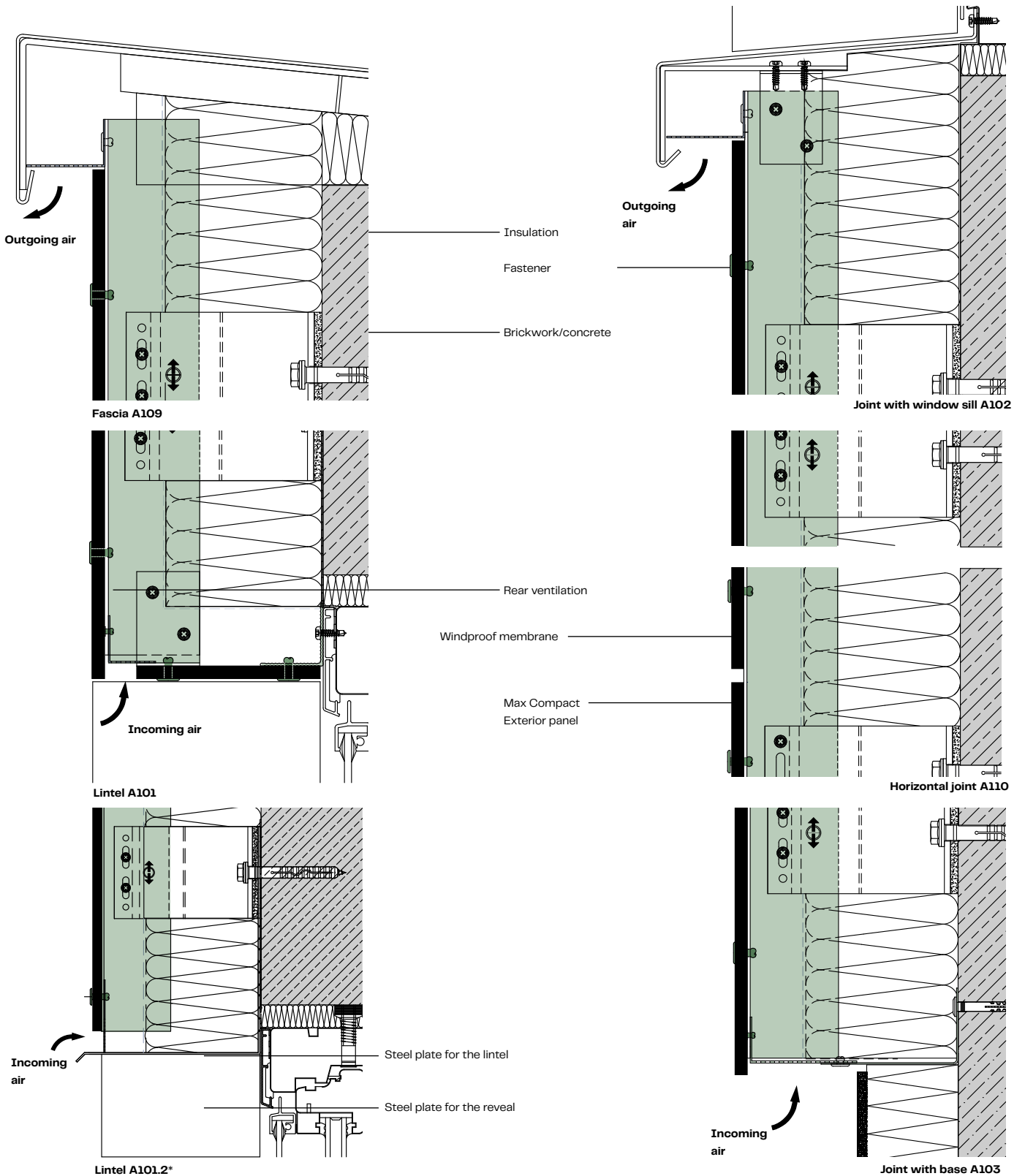

Construction Details—Horizontal Cross Section

Aluminum Substructure Riveted with Z/Omega Profiles

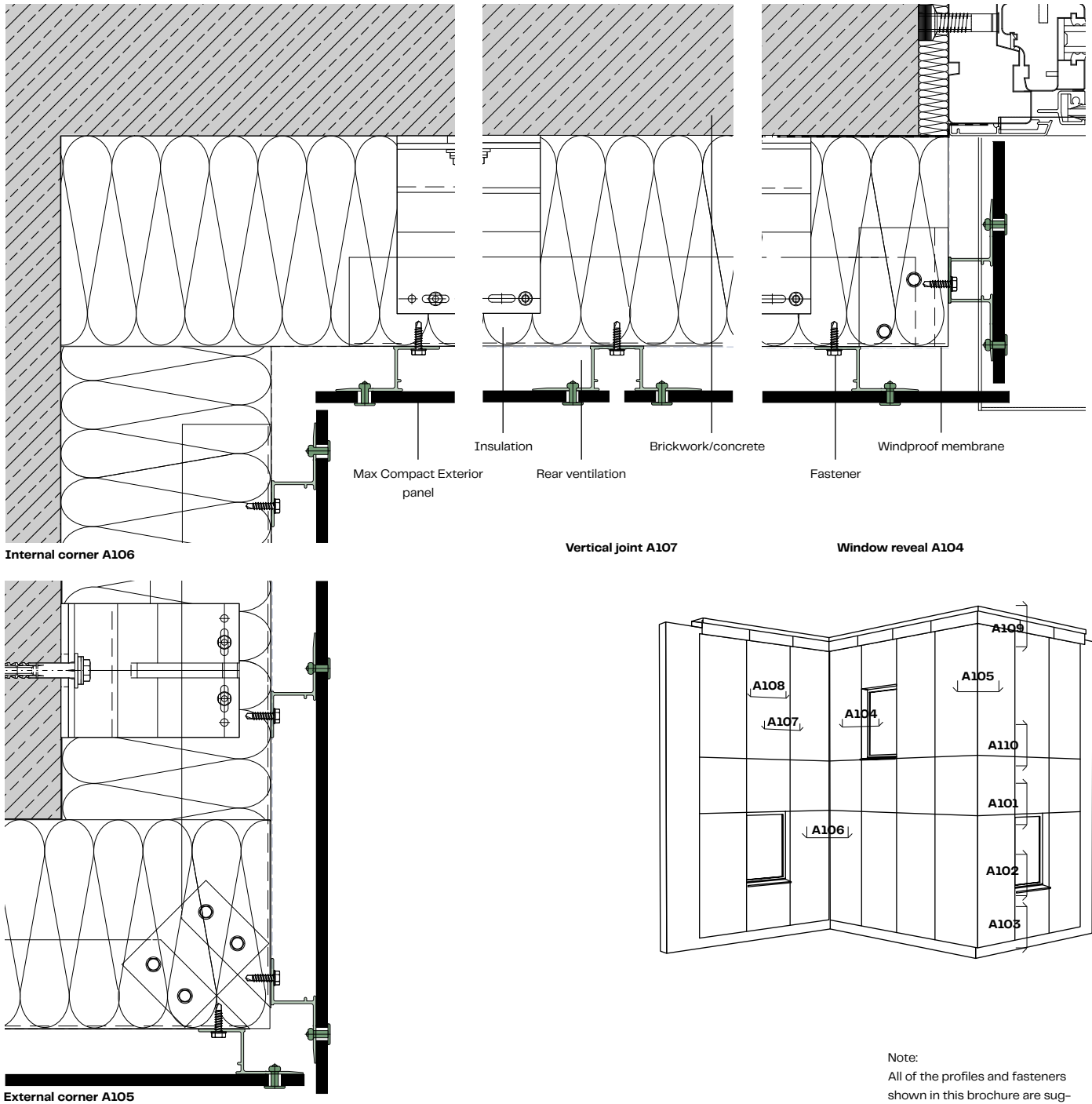

Note:
 All of the profiles and fasteners shown in this brochure are suggestions for planning purposes and not part of Fundermax's scope of delivery. Drawings are NOT to scale.

Suppliers:
 See end of the brochure.

Construction Details—Vertical Cross Section

Aluminum Substructure Riveted with Z/Omega Profiles

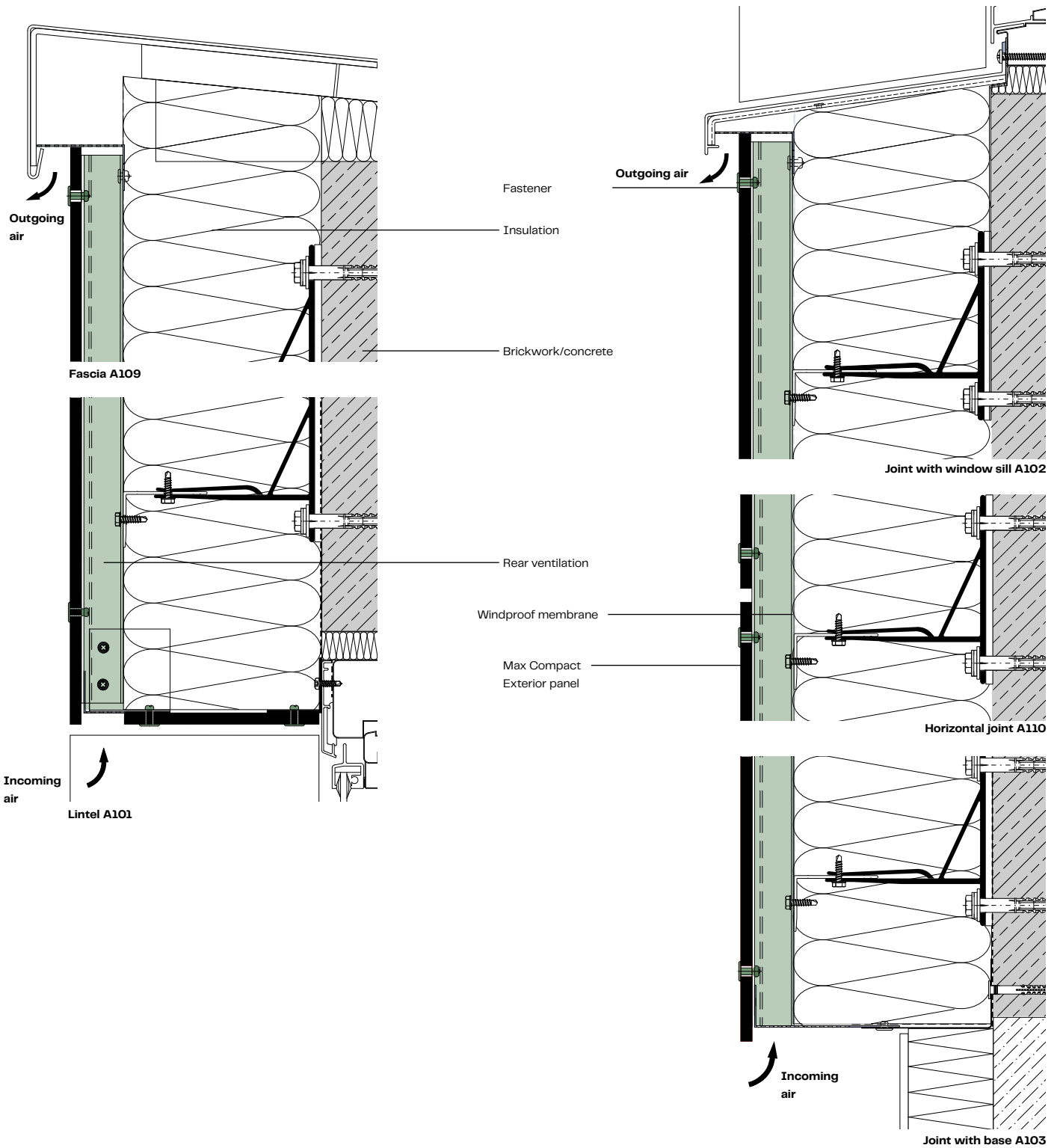

Invisible Glued Fastening Using an Adhesive System

Gluing

An alternative to invisible mechanical fastenings using plate anchors is gluing the facade panels using specially developed adhesive systems. These work on standard aluminum substructures. Rainscreen facades, fascias, soffits, and reveals can be removed cleanly and easily. Authorization is required from the relevant construction supervisory body on a local or national level. Adhesive systems are approved in conjunction with Max Compact Exterior panels in Germany.*

- Bostik ETA-22/0675
- PRO PART Klebe Dicht KD 385 Z-10.8-453
- Innotec Project System Z-10.8-483

Construction Examples

Required profile width: See building regulation approval. Find out the maximum panel size from the approval of the adhesive manufacturer. Local building regulations must be observed!

5 10

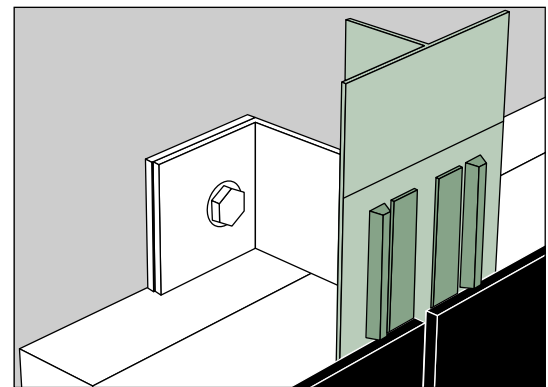

5 11

Single span

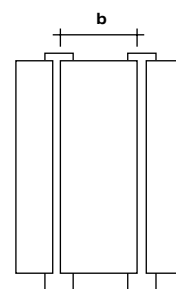

Adhesive tape
Glue
80–100 mm or ≥ 100 mm

5 12

Multiple spans

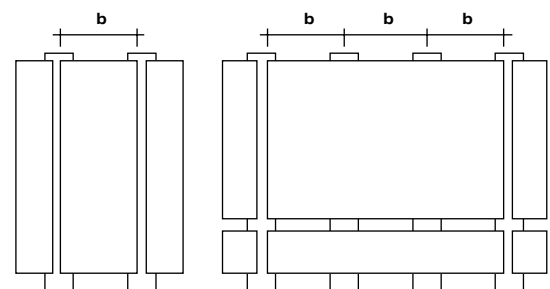

40 mm

Spacing of the vertical supporting structure— for glued installation using SikaTack Panel

Panel thickness	Single span panel max. b	Double span panel max. b
6.0 mm	450.0 mm	500.0 mm
8.0–10.0 mm	600.0 mm	650.0 mm

Gluing using the Innotec Project System** Single span panel

Austria, Germany, Switzerland	8.0 mm– max. b	10.0 mm–max. b
0.5 kN/m ²	838.0	1,048.0
1.0 kN/m ²	665.0	832.0
1.5 kN/m ²	581.0	727.0
2.0 kN/m ²	528.0	660.0

Gluing using the Innotec Project System** Double span panel

Austria, Germany, Switzerland	8.0 mm– max. b	10.0 mm–max. b
0.5 kN/m ²	1,125.0	1,406.0
1.0 kN/m ²	893.0	1,116.0
1.5 kN/m ²	780.0	975.0
2.0 kN/m ²	708.0	738.0

* Soffits do not have building regulation approval in Germany.

** Based on values provided for the Innotec approval. Country- and region-specific statics can be obtained from adhesive manufacturers. It is possible to glue 6.0 mm panels, but this does not have building regulation approval in Germany.

Workflow

Basics:

- Protect against the weather and dust while working (gluing tasks can be carried out on the construction site)
- Air temperature: Above 5°C but no higher than 35°C
- Relative humidity: No higher than 75%
- Temperature of parts to be glued: Min. 3°C higher than the dew point temperature of the air
- Do not glue Max Compact Exterior panels over joints between substructure profiles
- Arrange the substructure vertically
- Building regulation approval and manufacturer guidelines for use must be available on the building site
- Gluing to be carried out solely by verifiably trained companies (Germany: Proof of suitability according to building regulation approval)
- Prepare a construction site protocol

Pretreatment of Aluminum Substructures:

- Grind with a suitable abrasive fleece in accordance with the adhesive manufacturer's recommendation
- Clean using a suitable cleaning product* from the adhesive manufacturer
- Apply primer according to the adhesive manufacturer's recommendation
- Allow drying time for the cleaning product and primer according to adhesive manufacturer's instructions

Pretreatment of the Max Compact Exterior Panel:

- Grind with a suitable abrasive fleece in accordance with the adhesive manufacturer's recommendation
- Clean using a suitable cleaning product* from the adhesive manufacturer
- Apply primer according to the adhesive manufacturer's recommendation
- Allow drying time for the cleaning product and primer according to adhesive manufacturer's instructions
- All surfaces to be glued must remain clean, dry, and grease-free

Gluing:

- Obtain information from the manufacturer of the adhesive system.
- Apply the adhesive strip to the entire length of the vertical profile (do not remove the protection film yet!)
- Apply the glue in a triangle in accordance with the recommendation of the system manufacturer
- Remove the protection film from the adhesive strip
- Press down on the panels in the correct position (installation angle) until the adhesive strip makes contact

* Sika Aktivator-205 activates the panel surface and leaves behind a gray residue. Do not apply to the front side of the panel! Remove splashes immediately!

Note:

- Arrange the substructure vertically
- When choosing the material for the substructure (especially in the case of coated substructure profiles), take note of the building regulation approval and manufacturer instructions.

5 10 Installation using glue
5 11 Construction example—single span
5 12 Construction example—multiple span

Construction Details—Horizontal Cross Section

Gluing onto an Aluminum Substructure

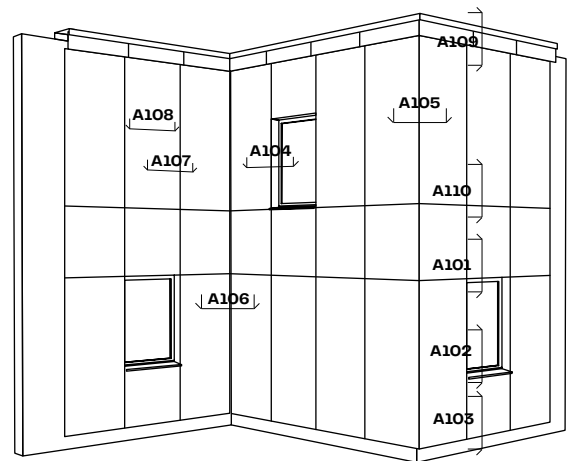
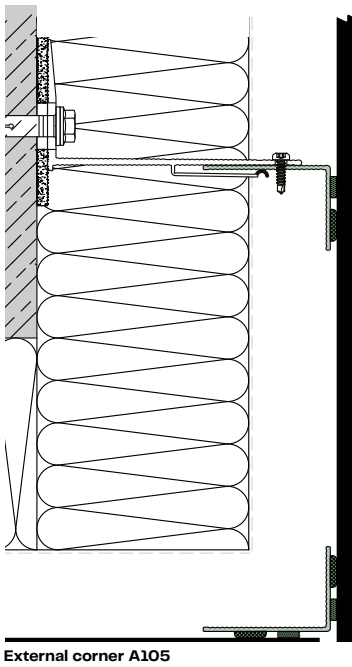
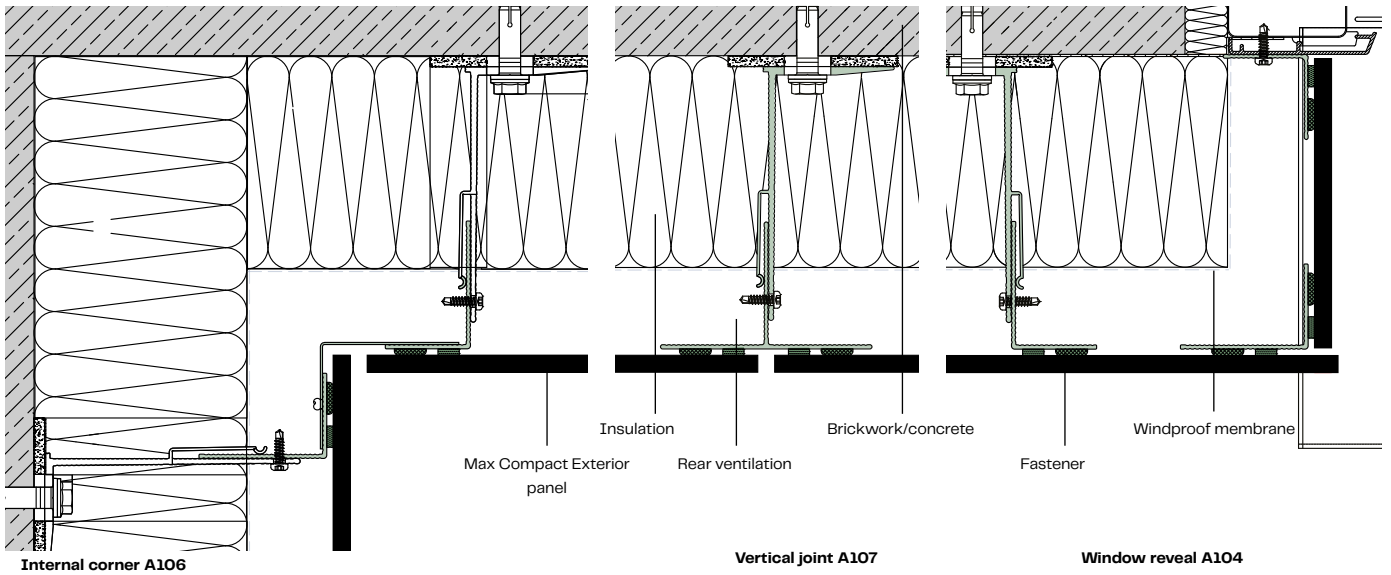

Note:
 All of the profiles and fasteners shown in this brochure are suggestions for planning purposes and not part of Fundermax's scope of delivery. Drawings are NOT to scale.

Suppliers:
 See end of the brochure.

Construction Details—Vertical Cross Section

Gluing onto an Aluminum Substructure

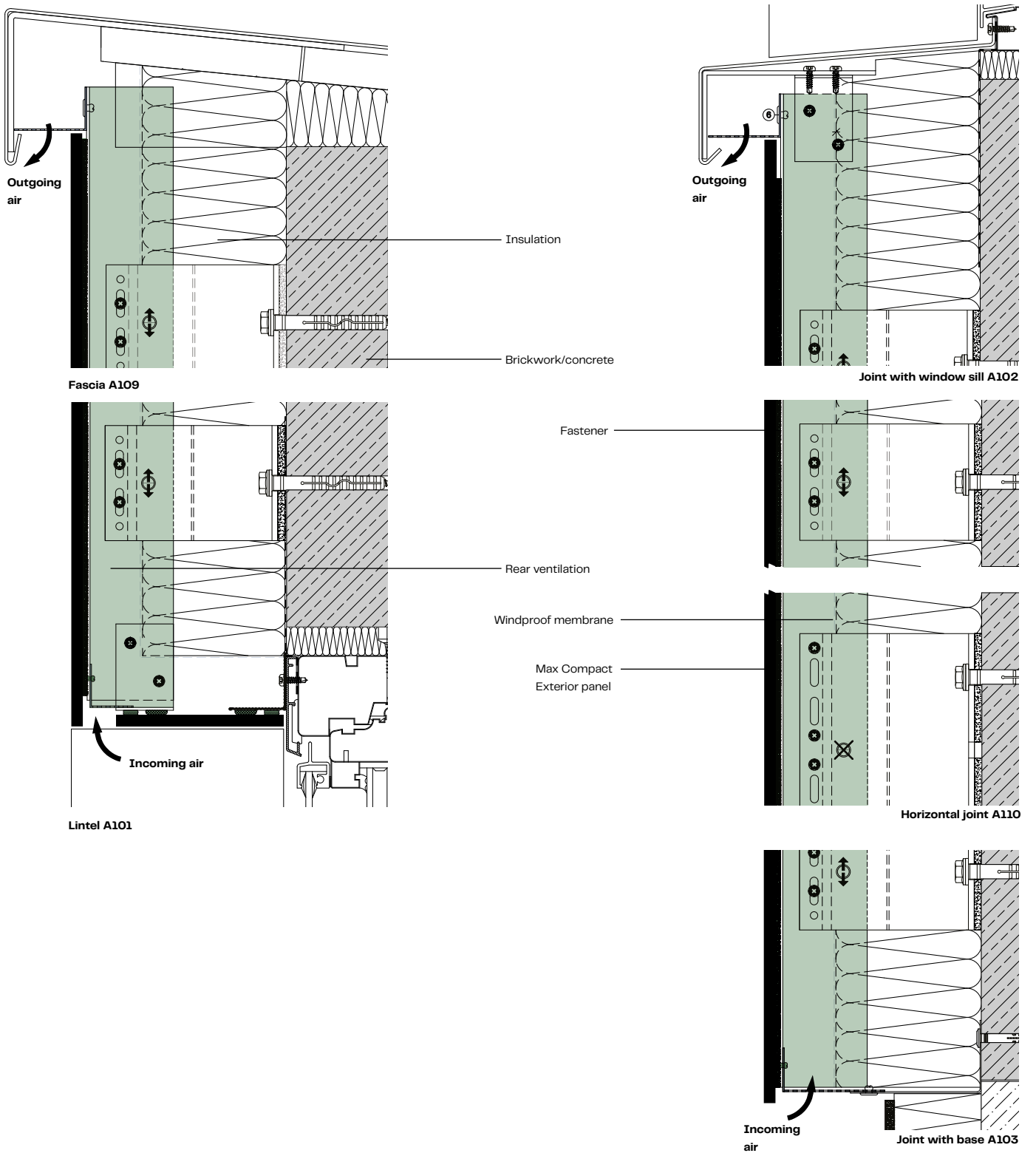

Construction Details—Horizontal Cross Section

Aluminum Substructure with Glued Z/Omega Profiles

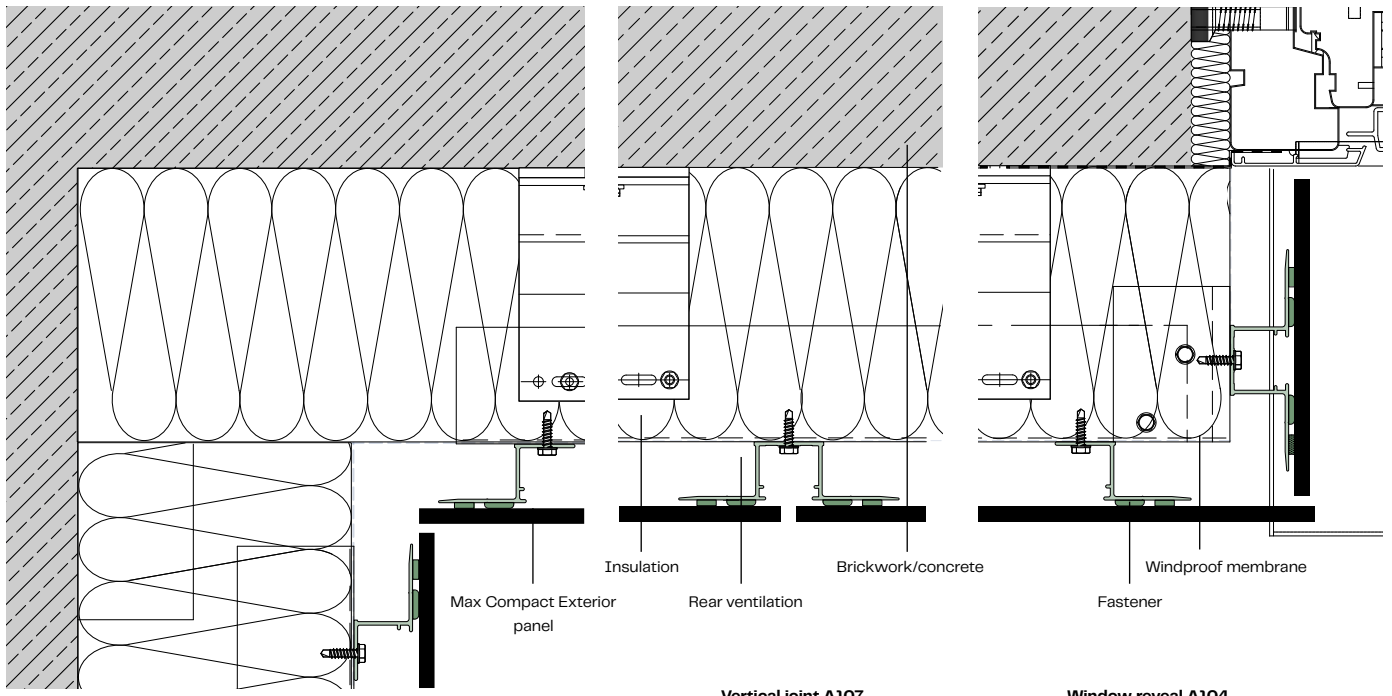

Internal corner A106

Vertical joint A107

Window reveal A104

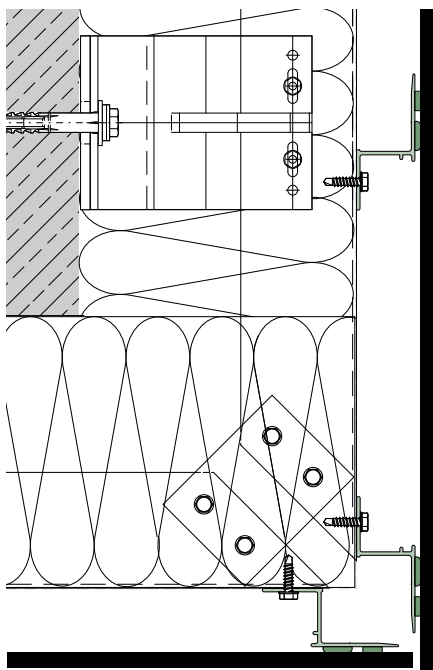

External corner A105

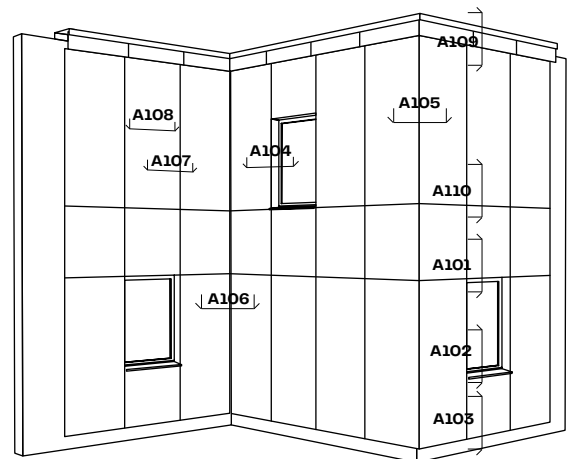

Note:
 All of the profiles and fasteners shown in this brochure are suggestions for planning purposes and not part of Fundermax's scope of delivery. Drawings are NOT to scale.

Suppliers:
 See end of the brochure.

Construction Details—Vertical Cross Section

Aluminum Substructure with Glued Z/Omega Profiles

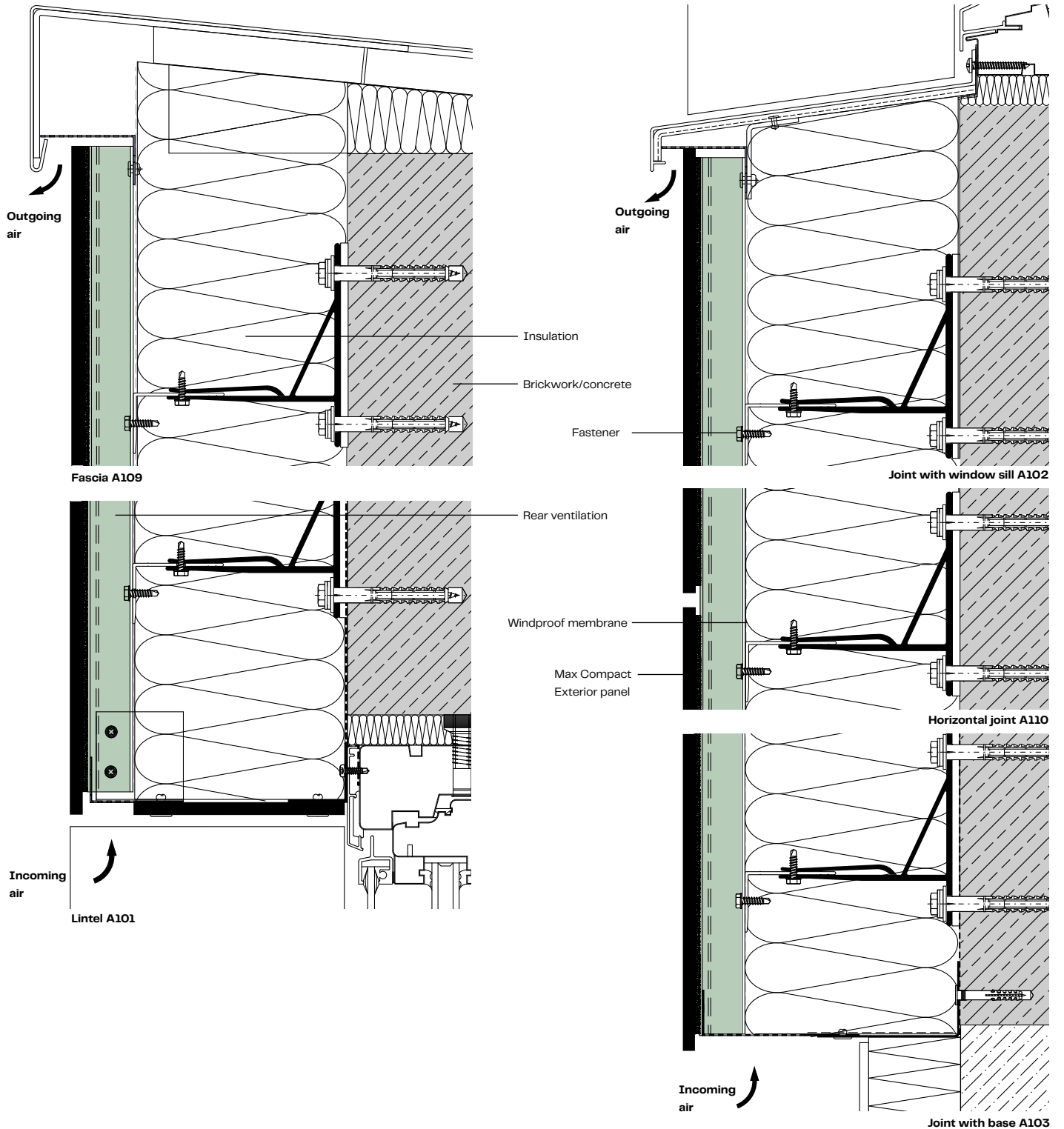

Invisible Mechanical Fastening Using Plate Anchors

Installing Max Compact Exterior panels using invisible mechanically attached agraffe profiles on an aluminum substructure. The Max Compact Exterior panel system components, agraffe profiles, plate anchors, and support profile work perfectly together.

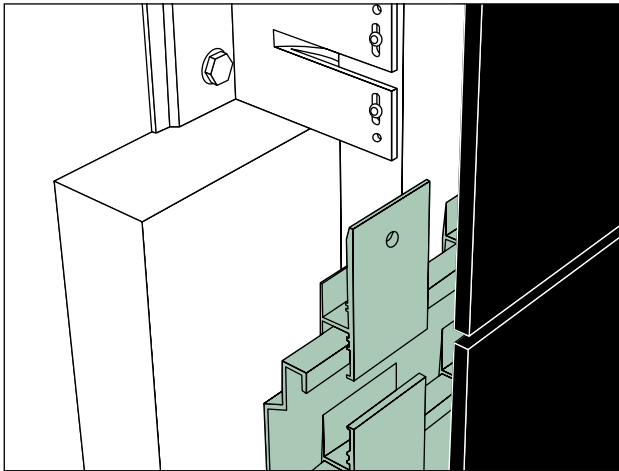

513

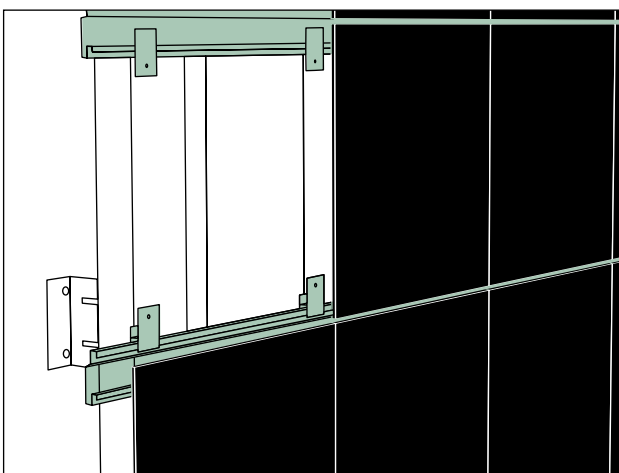

514

Attaching Agraffe Profiles

EU:

- SFS blind fastener TUF-S
- Building regulation approval ETA-15/O476

France:

- SFS TU-S 50 Avis Technique (2/16-1749)

For countries where no building regulation approval is required for fasteners, we recommend using one mentioned above. Local building regulations must be observed.

System Benefits

- Can be designed with horizontal or vertical panel/joint patterns
- Only one support profile for horizontal panel joints
- Experienced system partner
- No visible fastenings
- Installation process cost-effective and not dependent on weather
- Fastener approved by building authorities
- Suitable panel thicknesses: 8.0 and 10.0 mm, taking into consideration a min. 2.0 mm residual wall thickness (after deducting all tolerances)
- Quick to install using standard tools
- Drilling can be done on site using a battery drill
- High extraction value
- Reverse turn lock
- Can be dismantled using a hex key
- Installation of soffits

513 Invisible fastening with agraffe profiles

514 View of the installation surface

515 Blind fastener/agraffe profile detail

System Description

Hanging agraffe profiles are attached to the back of the Max Compact Exterior facade panel using blind fasteners in the pre-drilled fastener holes. The number of anchors should be calculated and the holes drilled in compliance with the relevant approval. The residual wall thickness between the drilled hole and the front side of the panel must be at least 2.0 mm after deducting all tolerances. Minimum distance from the edge: ≥ 40.0 mm; maximum distance from the edge: ≤ 80.0 mm.

Panels with agraffe profiles are hung on the hanging profiles attached to the substructure, adjusted for height, and secured against sideways movement. The substructure should be designed in such a way that ensures one unrestricted fastening point per panel. Do not cover joints between supporting profiles in the substructure with panels.

After detailed facade planning is complete, the panels will be cut and the holes drilled by us or a contractor, based on one CAD drawing per piece. The agraffe profiles can then be quickly attached using a rivet gun. Check execution in accordance with relevant approval.

Distance from Edge

Maintain a distance from the edge of 40.0–80.0 mm to ensure stability and flatness. For dimensional changes, panel joints should be at least 8.0 mm.

Notes

Panel drilling can also be provided and carried out by Fundermax in accordance with approvals.

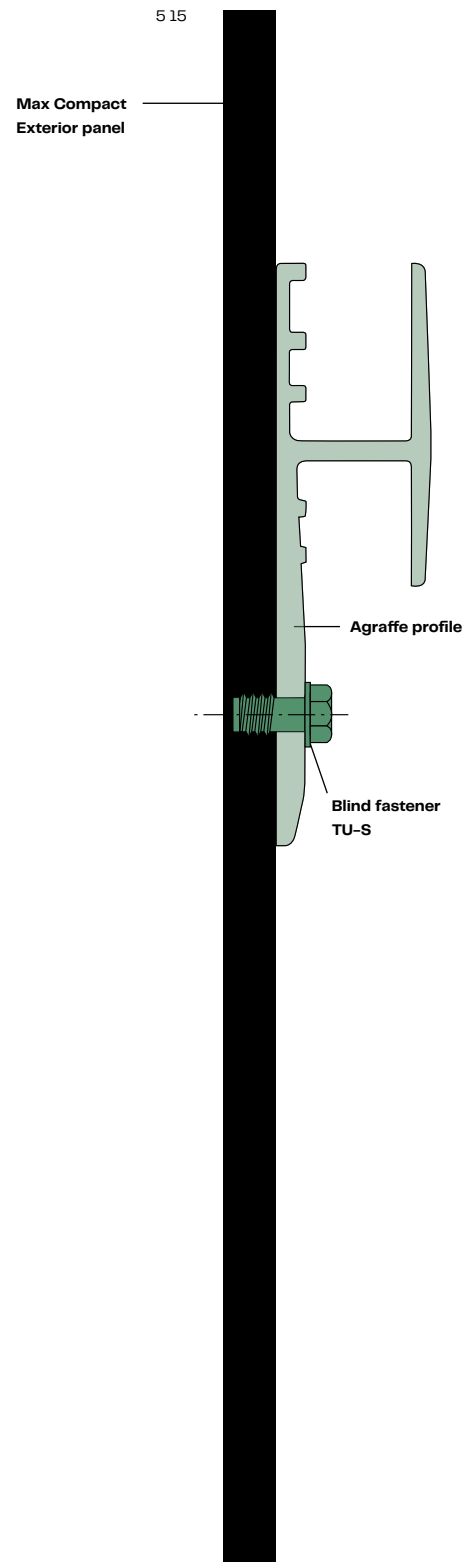

Invisible Mechanical Fastenings

Installing Max Compact Exterior panels using invisible mechanically attached agraffe profiles on an aluminum substructure. The Max Compact Exterior panel system components, agraffe profiles, self-tapping screws, and agraffe support profiles work perfectly together.

Attaching Agraffe Profiles

- Hilti S-HP02SS
- Building regulation approval ETA-21/0567

System Benefits

- Experienced system partner
- No visible fastenings
- Installation process not dependent on weather
- Installation of soffits
- Fastener approved by building authorities
- Suitable panel thicknesses: 8.0 mm and 10.0 mm
- Quick to install using standard tools
- Basic requirements: One drill bit, one self-tapping screw, and one drill bit holder for all panel thicknesses
- Easy execution: S-HP02SS self-tapping screw, drill bit, and drill bit holder with torque setting
- Hilti can supply a suitable rainscreen facade substructure
- High extraction value
- Possible to remove individual panels

System Description

The agraffe profiles are attached to the back of the Max Compact Exterior facade panels using specific self-tapping screws (S-HPO2SS) in the pre-drilled fastener holes. The number of anchors and drill holes must be calculated based on the relevant approvals.

Panels with agraffe profiles are hung on the hanging profiles attached to the substructure, adjusted for height, and secured against sideways movement. The substructure should be designed in such a way that ensures one unrestricted fastening point per Max Compact Exterior panel. Do not cover joints between supporting profiles in the substructure with panels—the agraffe profiles on one panel cannot be hung on two separate agraffe support profiles.

After detailed facade planning is complete (fastener spacing in accordance with approval), the Max Compact Exterior facade panels can be cut and drilled by Fundermax or a contractor, based on one CAD drawing per piece.

On the facade manufacturer's premises or on the construction site, the agraffe profiles can then be quickly attached using the provided drill bit holder with torque setting.

Check execution in accordance with relevant approval.



Construction Details—Horizontal Cross Section

Invisible Mechanical Fastening Using Plate Anchors

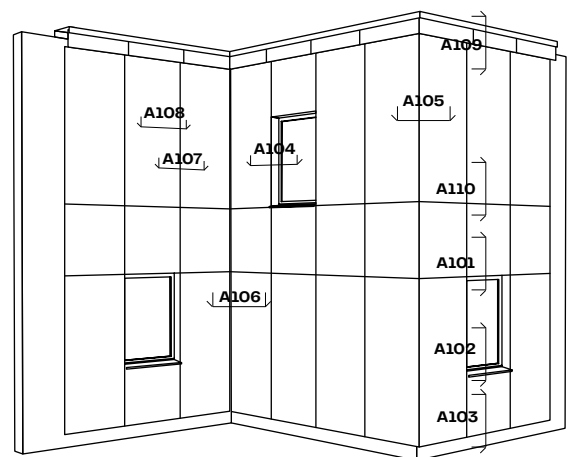
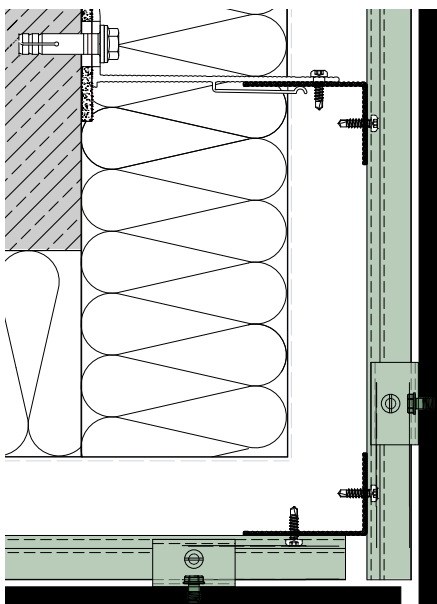
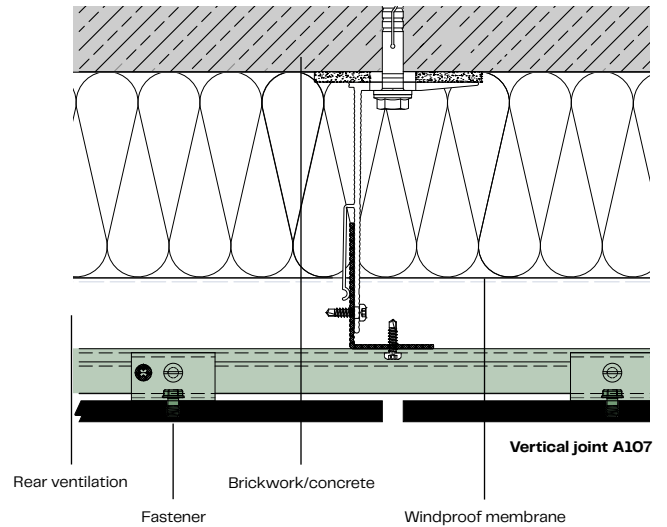
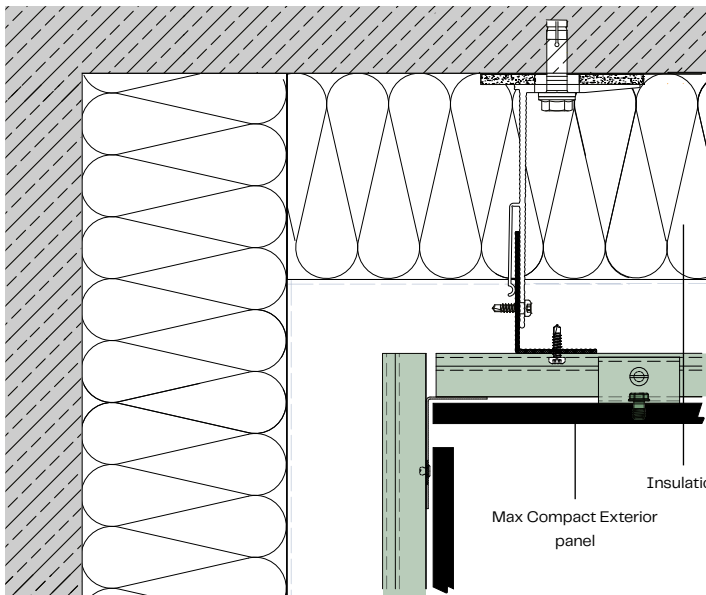

Note:
 All of the profiles and fasteners shown in this brochure are suggestions for planning purposes and not part of Fundermax's scope of delivery. Drawings are NOT to scale.

Suppliers:
 See end of the brochure.

Construction Details—Vertical Cross Section

Invisible Mechanical Fastening Using Plate Anchors

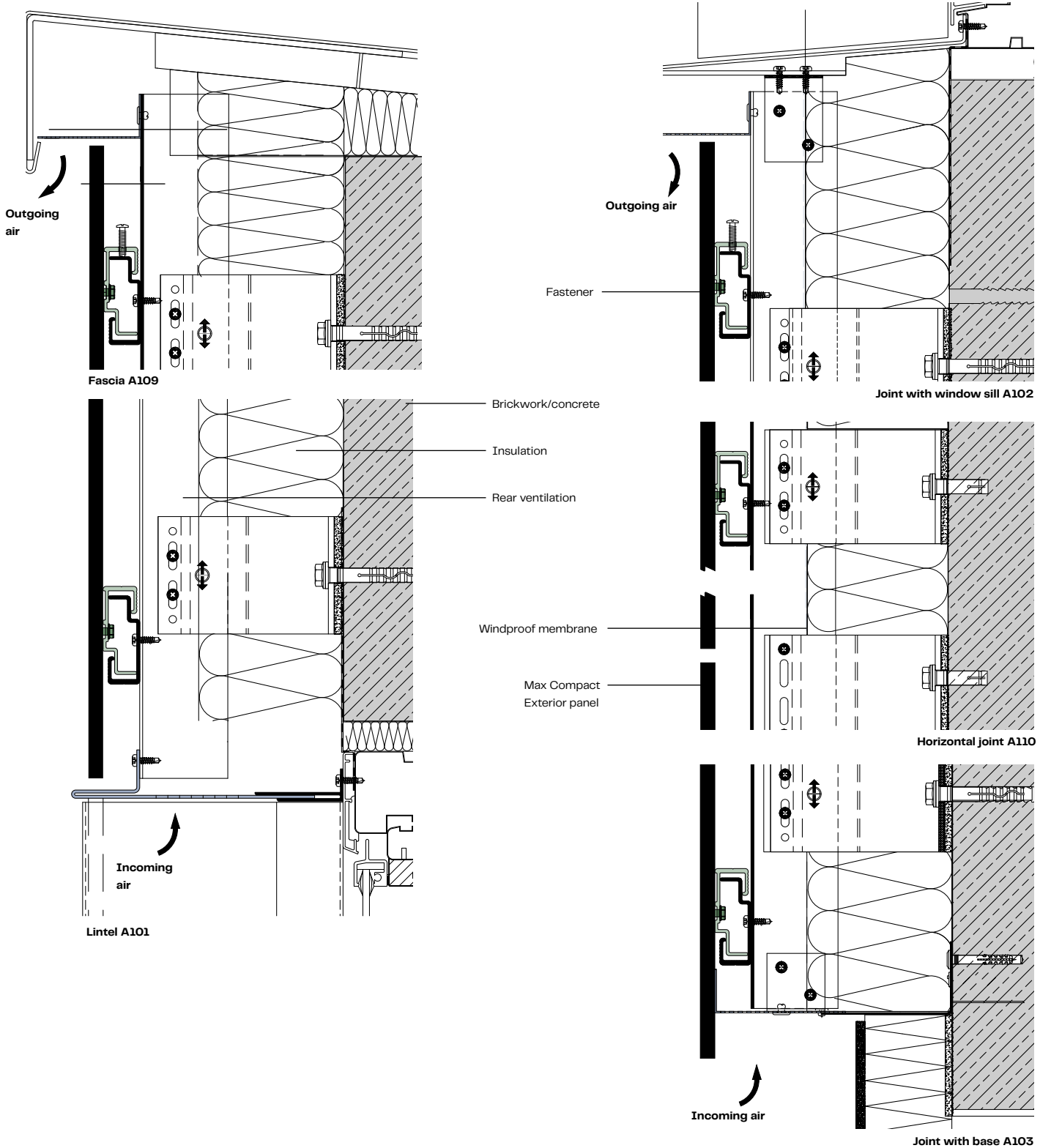

Important information about rainscreen facades on a timber substructure

The advantages of timber substructures are minimal thermal conductivity and longitudinal expansion, as well as the fact that wood is a renewable resource. To ensure durability, protection against moisture by means of construction design or chemical protection is essential. Chemical treatment of the wood can only be omitted in hazard class O (DE)/category of use O (AT) by using facades protected by eaves with closed joints.

To prevent moisture ingress via the screws, use pre-dried, planed battens (timber moisture content $15\% \pm 3$), e.g., spruce, fir, pine, or larch, as well as an EPDM membrane strip with a minimum thickness of 1.2 mm (see horizontal cross section image on page 59). Avoid moisture under the EPDM membrane strip in joints with fascias and windows!

PLEASE NOTE: Spruce must not be pre-drilled (DIN 1052). If the density of the timber is greater than 500 kg/m^3 : Pre-drill one hole diameter smaller than the diameter of the shaft of the screw in accordance with DIN 1502-12.6(4) using the formula $0.6 \times d$ or $0.8 \times d$.

Detailed requirements can be found in the respective applicable standards and guidelines (see list of standards on page 59). Since wood behaves like a natural material, it is necessary to carry out regular visual checks of the facade. Tighten screws as required. Installation on a timber substructure must be carried out with prefabricated panels (cut, drilled, and beveled, if applicable).

Timber Protection by Means of Construction Design

According to standards, structural protective measures for timber include design- and construction-related processing and machining provisions that serve to preserve the usability of wood and wood-based materials. These measures prevent fungal infestations and excessive shrinkage and swelling. These measures will not prevent insect infestations.

Taking the measures below into account will have an impact on the functionality and life span of the substructure. When building timber substructures for facades, up-to-date processing guidelines for timber structural engineering apply, subject to the installation location or other guidelines. The contractor is responsible for ensuring compliance. For that reason, construction-related and chemical timber protection should be specified during the planning phase for the substructure.

Effective Protective Measures

Protection against moisture penetration in battens:

Using an EPDM membrane strip at least 1.2 mm thick. Only this minimum thickness will seal the drill hole completely and prevent moisture ingress via the fastening screws. The strip should be used on all battens and be at least 20.0 mm wider than the batten (see page 64). This prevents wood-decay fungi, which grow when the moisture content is greater than 20% (DIN EN 335-1, annex A, 2.19).

Protection against precipitation:

(E.g., via a canopy, a weather cover on the fascias, window sill closures, etc.): A roof overhang will permanently prevent moisture from penetrating the facade when it rains. The size of this overhang will depend on the height of the facade and the position of the building.

Protection against spray:

Timber substructures are very sensitive to permanent moisture penetration. For this reason, they should be at least 300.0 mm above the water-bearing level. In the case of smooth flooring and harsh weather conditions, the area exposed to spray increases accordingly.

Protection against rising damp:

In buildings that suffer from rising damp, damp-proof layers should be installed between the brickwork/concrete and the timber substructure. This will prevent persistent moisture penetration in the timber.

Protection against condensation:

(E.g., by using a vapor barrier, rear ventilation of shuttering, insulating cold water pipes): To avoid condensation constantly building up in the rain-screen facade, always ensure proper air flow.

The clear vertical rear ventilation gap must be at least 200.0 cm²/m. For timber substructures, a clear minimum cross section of 150.0 cm²/m for air inlets and outlets is required (see ÖNORM B 8110-2:2003). For vertical throughflow, arrange support frames vertically.

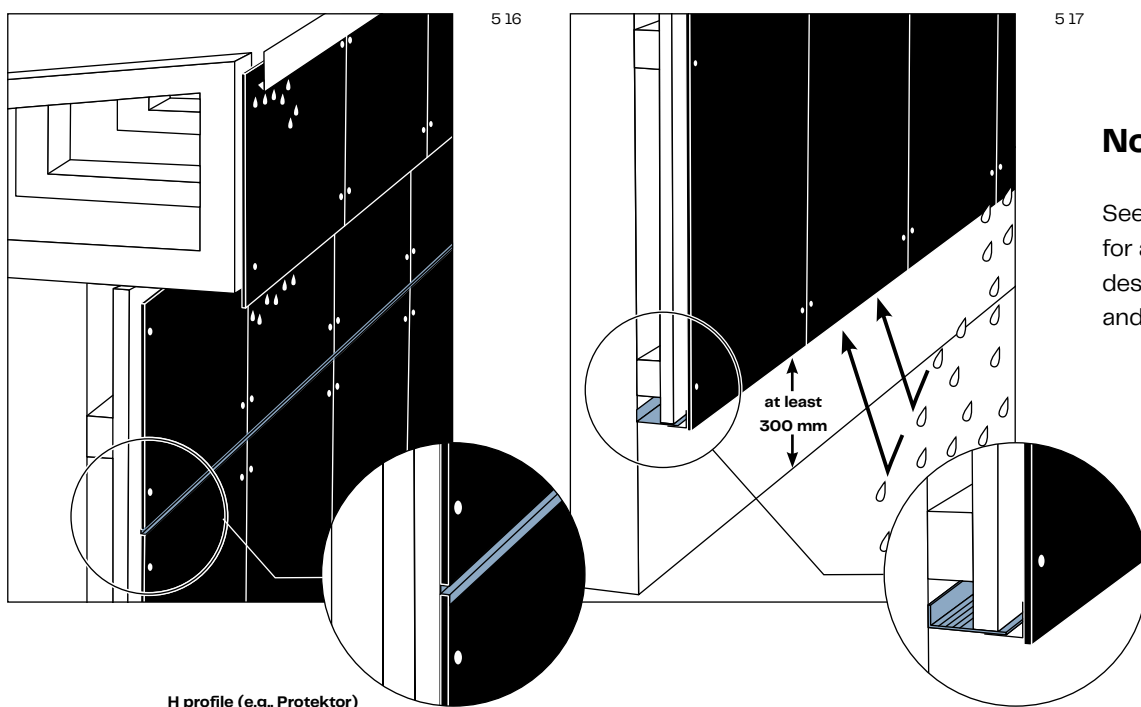

Notes

See also the measures for avoiding errors described on pages 58 and 59.

Avoiding Errors with a Timber Substructure

Based on the latest practical knowledge and continuous practical experience, we recommend the following approach to timber substructures. To avoid errors when building the timber substructure, there are a few important things to consider. On these pages, we will present the main problem areas in pictures to show our recommendations.

Correct batten/correct EPDM strip 1.2 mm thick and 10.0 mm protruding on each side (see detailed section on page 64).

Not using an EPDM strip or using an EPDM strip that is thinner than 1.2 mm and metal or sheet strips are proven to be unsuitable.

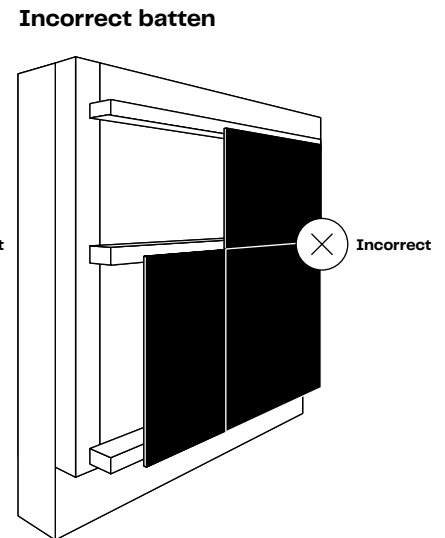
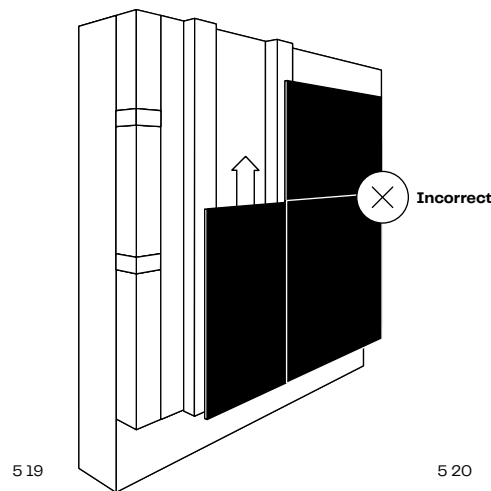
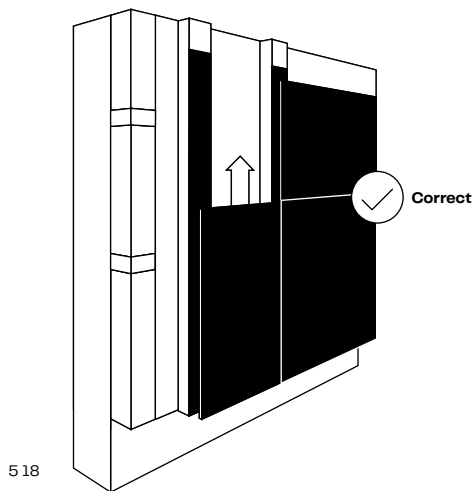

Please Note:

- Batten should be planed and pre-dried (15% ±3')
- Ensure construction-related and/or chemical timber protection.
- Use an EPDM strip with a minimum thickness of 1.2 mm and an overhang of 10.0 mm on each side on all battens.
- Adapt at the base to the subsurface.
- A timber substructure is only permitted if there is sufficient construction-related timber protection (roof overhang).
- All horizontal joints should be closed using a suitable profile (see Fig. 5 21).

Draining precipitation

Vertical cross section

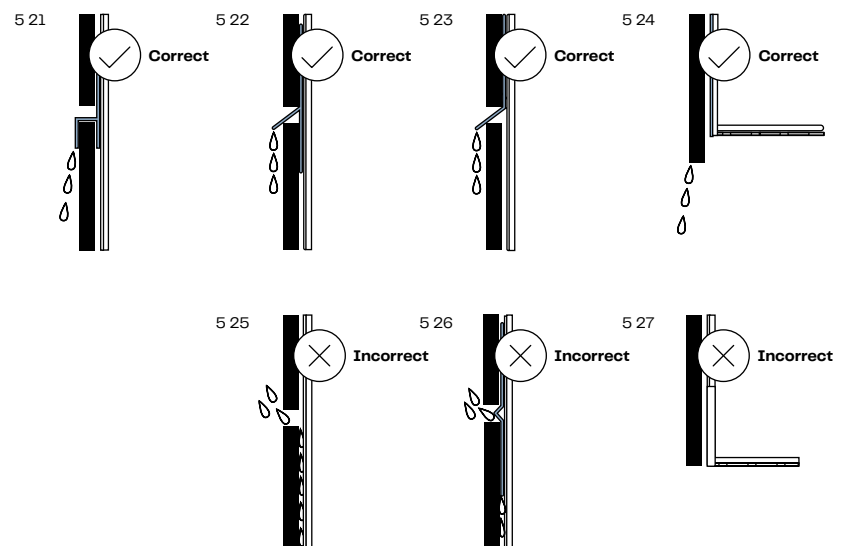

- 5 18 Correct batten/correct EPDM strip
- 5 19 Missing EPDM strip
- 5 20 Incorrect batten
- 5 21 Correct joint profile
- 5 22 Correct joint profile
- 5 23 Correct joint profile
- 5 24 Correct overhang (drip edge)
- 5 25 Missing joint profile
- 5 26 Incorrect joint profile

$$* \text{Moisture content of timber} = \frac{\text{Water content}}{\text{Dry mass}} \times 100 \text{ in } \%$$

**Fixed point hole D = 6.0 mm /
do not use countersink**

**Sliding point hole D = 8.0 mm /
do not use countersink /
for hole diameter, see page 62**

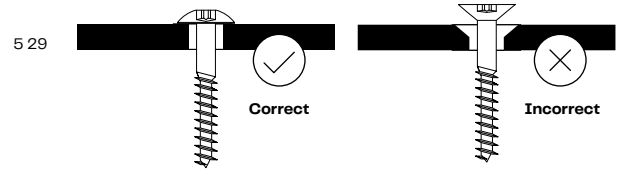
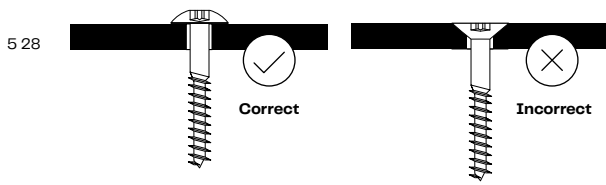

Capillary action / avoiding tight joints

Horizontal cross section

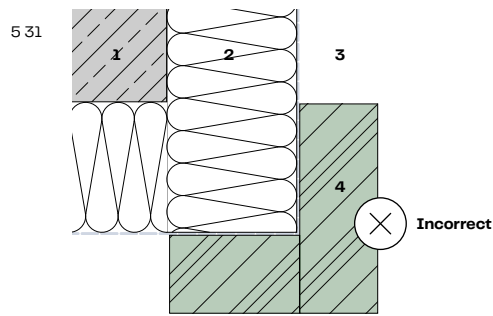
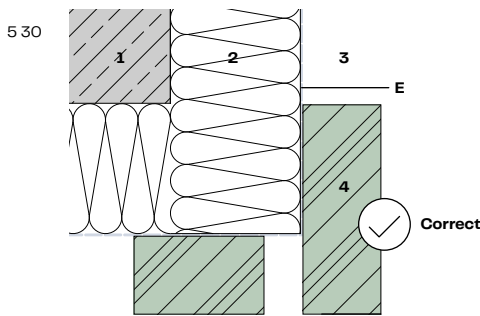

Version with edge profile

Horizontal cross section

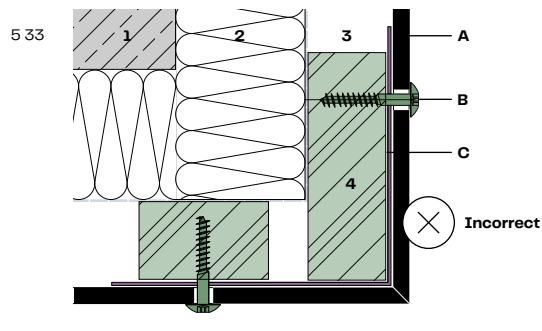
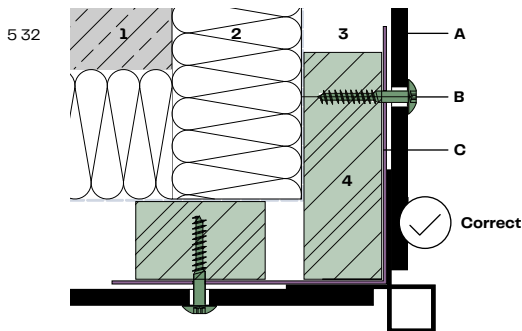

Version with open joints and Max Compact Exterior panel overhang

Horizontal cross section

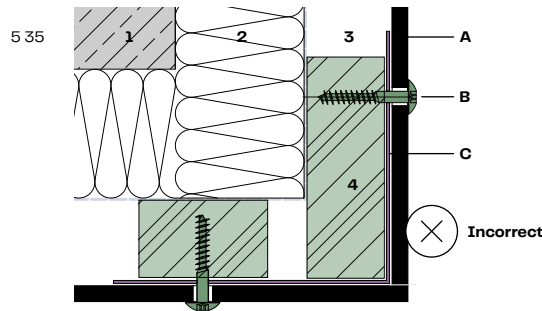
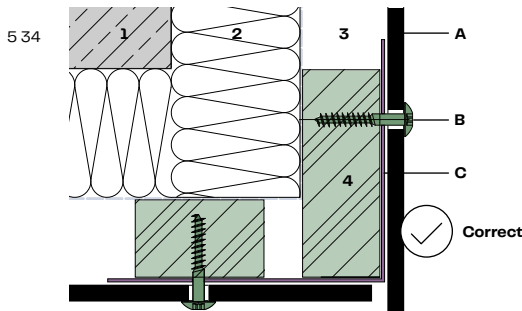

Key

- 1 Brickwork/concrete
- 2 Insulation
- 3 Rear ventilation
- 4 Chemically protected battens
- A Max Compact Exterior panel
- B Fastener
- C EPDM membrane strip at least 1.2 mm thick
- E Windproof membrane

- 5 27 Missing overhang
- 5 28 Fixed point hole
- 5 29 Sliding point hole
- 5 30 Correct spacing of timber battens
- 5 31 Missing spacing of timber battens
- 5 32 Correct corner construction
- 5 33 Incorrect corner construction
- 5 34 Correct open corner construction
- 5 35 Incorrect corner construction

Standards for Timber Construction

Notes

Please take note of the valid and current versions of the standards opposite.

ÖNORM B 2215

Timber construction works

ÖNORM B 3801

Timber protection in building construction – terms, definitions, and basics

ÖNORM B 3802-1

Timber protection in the building trade – Part 1: General

ÖNORM B 3802-2

Timber protection in the building trade – Part 2: Structural protection of the timber

ÖNORM B 3802-3

Timber protection in the building trade – Part 3: Chemical protection of the timber

ÖNORM B 3802-4

Timber protection in the building trade – Part 4: Measures to combat and remedy fungal and insect infestations

ÖNORM B 3803

Timber protection in building construction – coatings on dimensionally accurate external components made out of wood – minimum requirements and tests

ÖNORM EN 1995-1-1

Dimensioning and construction of timber structures – Part 1-1: General – General rules and rules for building construction

ÖNORM B 8110-2

Thermal insulation in building construction – Part 2: Water vapor diffusion and protection against condensation – form for temperature and water vapor diffusion calculation



DIN EN 350

Durability of timber and timber products – testing and classification of the durability of timber and timber products against biological attack

DIN 1052-10

Manufacture and execution of timber structures – Part 10: Additional provisions

DIN 4108-3

Thermal insulation and energy saving in buildings – Part 3: Climate-related protection against moisture; requirements, calculation methods, and notes for planning and execution

DIN 18516-1

External cladding, rear ventilated – Part 1: Requirements, testing principles

DIN 68800-1

Timber protection – Part 1: General

DIN 68800-2

Timber protection – Part 2: Preventive structural measures in building construction

DIN 68800-3

Timber protection – Part 3: Preventive protection of timber using wood preservatives

DIN 68800-4

Timber protection – Part 4: Measures to combat and remedy wood-decay fungi and insects

DIN 4074-1

Sorting wood according to durability – Part 1: Sawn softwood

DIN 4074-5

Sorting wood according to durability – Part 5: Sawn hardwood

DIN EN 335

Durability of timber and timber products – use classes: Definitions, applications of solid wood and timber products

DIN EN 336

Timber for load-bearing purposes – dimensions, permissible deviations

DIN EN 338

Timber for load-bearing purposes – grades

EN 14081

Timber structures – timber sorted according to strength for load-bearing purposes with rectangular cross section

Part 1: General requirements

Part 2: Automatic sorting: Additional requirements for the initial test

Part 3: Automatic sorting: Additional requirements for in-house production monitoring

ÖFHF

Association rules of the ÖFHF – data sheet for rainscreen facades on timber substructures (dated March 10, 2014)

IFD

Guidelines for assessing the execution quality of rainscreen facades

Installing Max Compact Exterior Panels Using Screws on a Timber Substructure

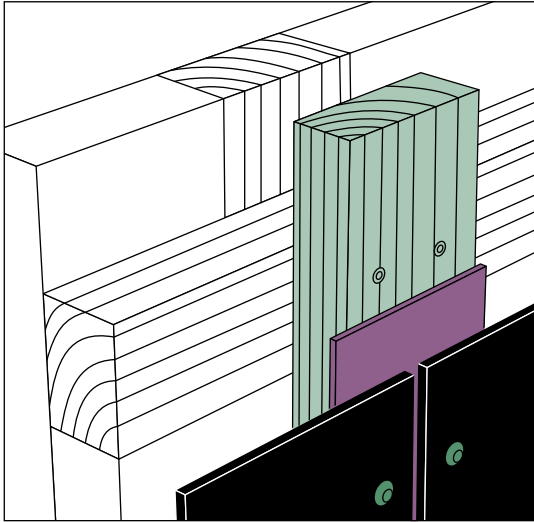

5 36

Substructure

Please consider the notes on pages 54 to 57. If no structural verification is necessary: Set the dimensions of horizontal battens and counterbattens at a minimum of 60.0 x 40.0 mm, vertical battens at a minimum of 50.0 x 30.0 mm. Joints: 100.0 x 30.0 mm. Due to the characteristics of the Max Compact Exterior material, it is necessary to drill fixed and sliding points at the time of installation (see Fig. 5 39 and Fig. 5 40). In the case of thicker insulation, counterbattens should be made (Fig. 5 36).

Note:

To achieve the best possible facade cladding look with the NG surface, installation using adhesive on an aluminum substructure is recommended. Subframe types such as timber are not suitable because of their material-related properties, as any unevenness in the substructure will cause a wavy overall appearance.

Fixed Point

Fixed points serve to evenly distribute (halve) changes in size. Drill hole diameter in Max Compact Exterior panels:
6.0 mm.

Sliding Point

The diameter of the drill hole in the Max Compact Exterior panel must be larger than the diameter of the fastener, depending on the required expansion clearance. The diameter of the drill hole is the shaft diameter of the fastener plus 2.0 mm per meter of cladding material starting from the fixed point. The fastener head must cover the drill hole. Apply fasteners starting from the fixed point and working outward. Position screws centrally in the panel holes and do not screw in too tight (the panel should still be able to move). The spacing of screw heads on the surface of the panel should be 0.3 mm to allow for movement of the parts in the drill hole (e.g., Festool DC UNI FF depth stop). Do not use countersunk screws. Use a centering aid.

Forming Joints

To ensure that Max Compact Exterior panels can move without restriction, opt for joints of at least 8.0 mm.

Fasteners

Only use fasteners made out of non-corrosive materials—Max Compact Exterior installation screw (see Fig. 5 37) with Torx 20 made out of stainless steel X5Cr Ni Mo 17122 material no. 1.4401 V4A. Lacquered head available on request.

Drill hole diameter in

Max Compact Exterior panels:

Sliding points: 8.0 mm/as required, fixed points: 6.0 mm

Distance from Edge

Maintain a distance from the edge of 20.0–80.0 mm to ensure stability and flatness. Ensure joints between panels are at least 8.0 mm to accommodate dimensional changes (see Fig. 5 38).

Fastener Spacing

Observe relevant structural requirements. If this is not necessary based on local building regulations, use values in the tables on pages 62 and 63.

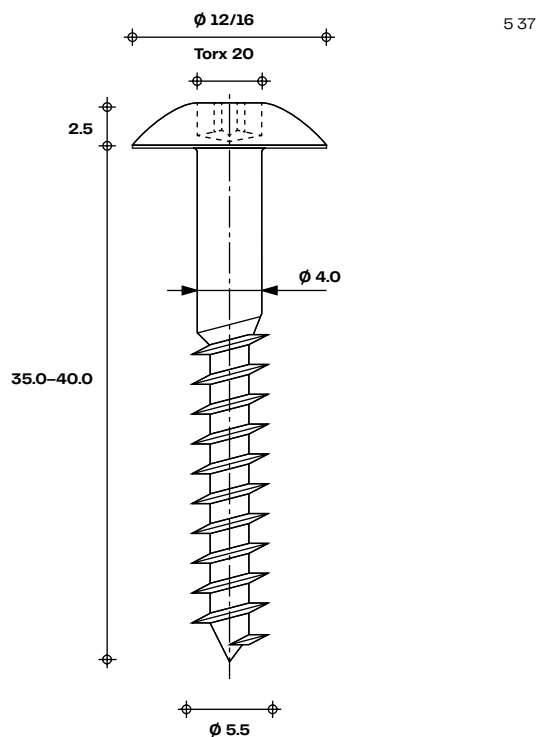

5 37

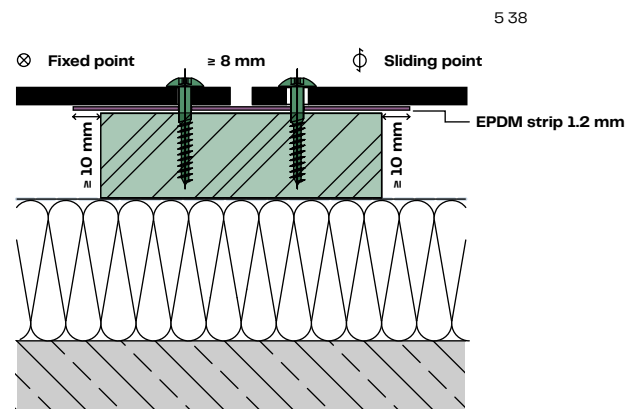

5 38

5 36 Installation screwed onto a timber substructure

5 37 Max Compact Exterior installation screw

5 38 Example vertical joint/fixed point/sliding point

Load table for single span panels/wind load* Max Compact Exterior panels screwed onto timber substructure

Panel thickness	6.0 mm		8.0 mm		10.0 mm	
Load q (kN/m ²)	max. b (mm)	max. a (mm)	max. b (mm)	max. a (mm)	max. b (mm)	max. a (mm)

Germany*

0.50	600.0	600.0	700.0	700.0	800.0	800.0
1.00	600.0	431.0	700.0	539.0	800.0	551.0
1.50	600.0	311.0	700.0	373.0	800.0	431.0
2.00	537.0	261.0	700.0	280.0	800.0	323.0

Values refer to DIN 1055-T4 or DIN 18516 and approval Z-10.3-712.

Austria*

0.50	781.0	662.0	970.0	649.0	1,146.0	769.0
1.00	657.0	394.0	815.0	463.0	964.0	457.0
1.50	594.0	314.0	737.0	354.0	871.0	396.0
2.00	537.0	261.0	686.0	286.0	811.0	319.0

Values refer to ÖNORM B 4014-1,2 or EN 1991-1-4 and approval Z-10.3-712.

Switzerland*

0.50	781.0	662.0	970.0	649.0	1,146.0	769.0
1.00	657.0	394.0	815.0	463.0	964.0	457.0
1.50	594.0	314.0	737.0	354.0	871.0	396.0
2.00	537.0	261.0	686.0	286.0	811.0	319.0

Values refer to SIA standard 261 and approval Z-10.3-712.

Fastener Spacing for Austria and Switzerland

If the axis "b" stated is not fully used, you can calculate the permissible fastener spacing "a" as follows

(Source: Max Compact Exterior facade panel structural standard and Gerald Segeth, Dobel April 18, 2011):

When installing an 8.00 mm-thick double span panel and with a wind load of 0.5 kN/m²:

max. b = 1,209.0 mm

max. a = 343.0 mm

If "b" = 1,000.0 mm, for example,

the maximum permissible "a" is calculated as follows:

$$\text{perm a} = \frac{\text{max. b}}{\text{current b}} \times \text{max. a}$$

$$\text{perm a} = \frac{1,209.0 \text{ mm}}{1,000.0 \text{ mm}} \times 343.0 \text{ mm} = 414.0 \text{ mm}$$

* Interpolation is possible based on this value. Example: In the case of non-utilization of the max. b value: Permissible a = (max b/current b) * max. a
Important: Permissible a < max b

** Values in the calculation table are typical values. Tables for a wind load range of between 0.3 kN/m² and 2.6 kN/m² are available from the Fundermax support team on request.

Load table for double span panels/wind load* Max Compact Exterior panels screwed onto timber substructure

Panel thickness	6.0 mm		8.0 mm		10.0 mm	
Load q (kN/m ²)	max. b (mm)	max. a (mm)	max. b (mm)	max. a (mm)	max. b (mm)	max. a (mm)

Germany*

0.50	600.0	600.0	700.0	591.0	800.0	517.0
1.00	600.0	345.0	700.0	296.0	800.0	259.0
1.50	600.0	230.0	700.0	197.0	800.0	172.0
2.00	537.0	193.0	700.0	148.0	800.0	129.0

Values refer to DIN 1055-T4 or DIN 18516 and approval Z-10.3-712.

Austria*

0.50	974.0	425.0	1,209.0	343.0	1,429.0	290.0
1.00	759.0	273.0	1,012.0	205.0	1,201.0	172.0
1.50	620.0	223.0	826.0	167.0	1,033.0	134.0
2.00	537.0	193.0	7,116.0	145.0	894.0	116.0

Values refer to ÖNORM B 4014-1,2 or EN 1991-1-4 and approval Z-10.3-712.

Switzerland*

0.50	974.0	425.0	1,209.0	343.0	1,429.0	290.0
1.00	759.0	273.0	1,012.0	205.0	1,201.0	172.0
1.50	620.0	223.0	826.0	167.0	1,033.0	134.0
2.00	537.0	193.0	716.0	145.0	894.0	116.0

Values refer to SIA standard 261 and approval Z-10.3-712.

- ⊗ Fixed point
- ⊕ Sliding point

5 39

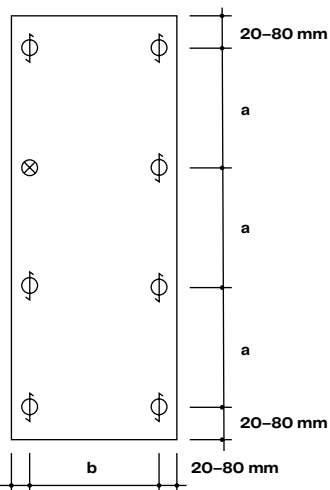

5 39 Single span panel

5 40

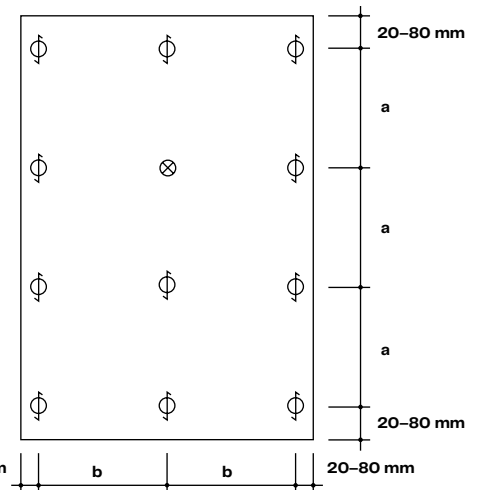

5 40 Double span panel

Construction Details—Timber Substructure Horizontal Cross Section

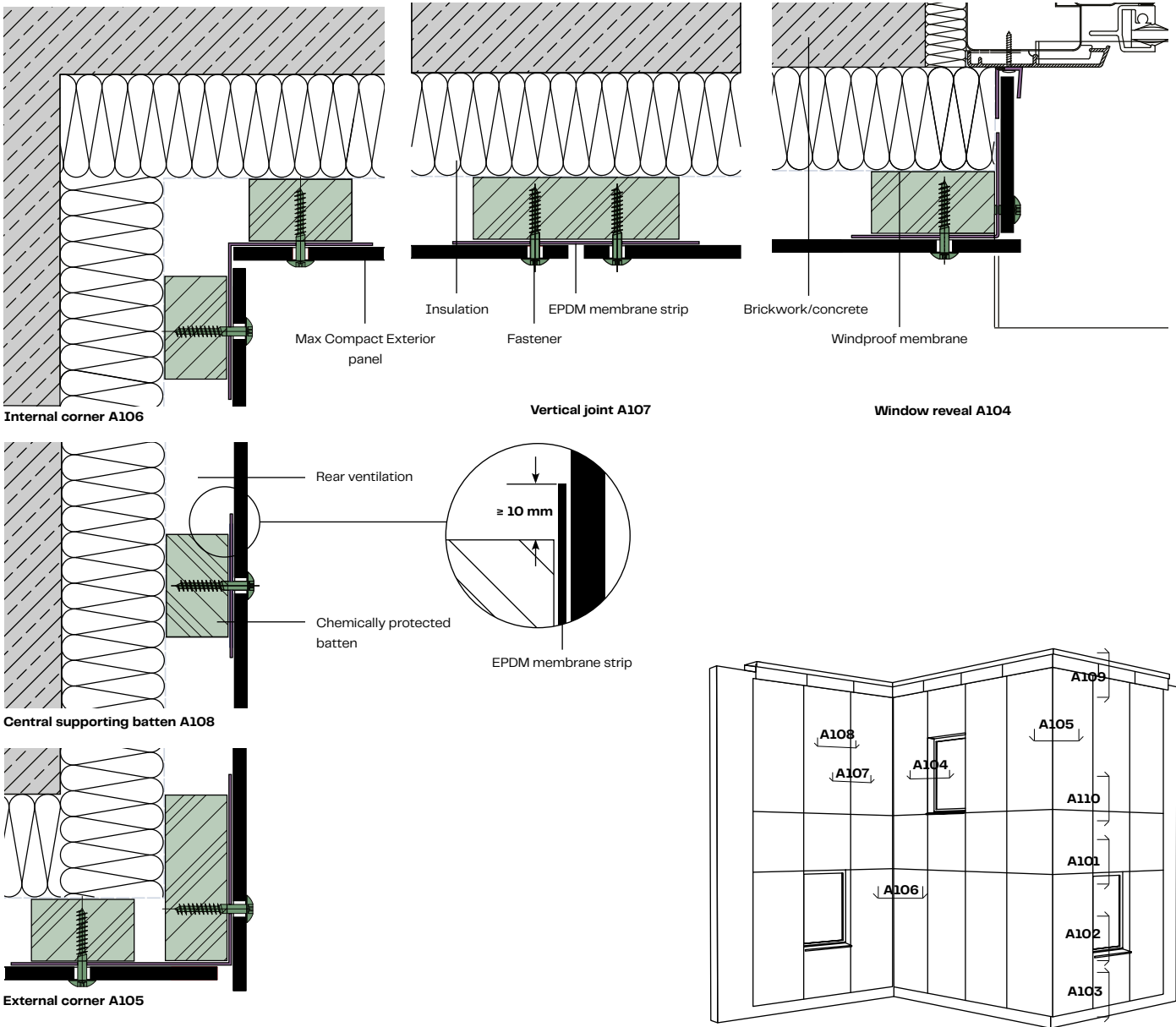

Note:
 All of the profiles and fasteners shown in this brochure are suggestions for planning purposes and not part of Fundermax's scope of delivery. Drawings are NOT to scale.

Suppliers:
 See end of the brochure.

Construction Details—Timber Substructure Vertical Cross Section

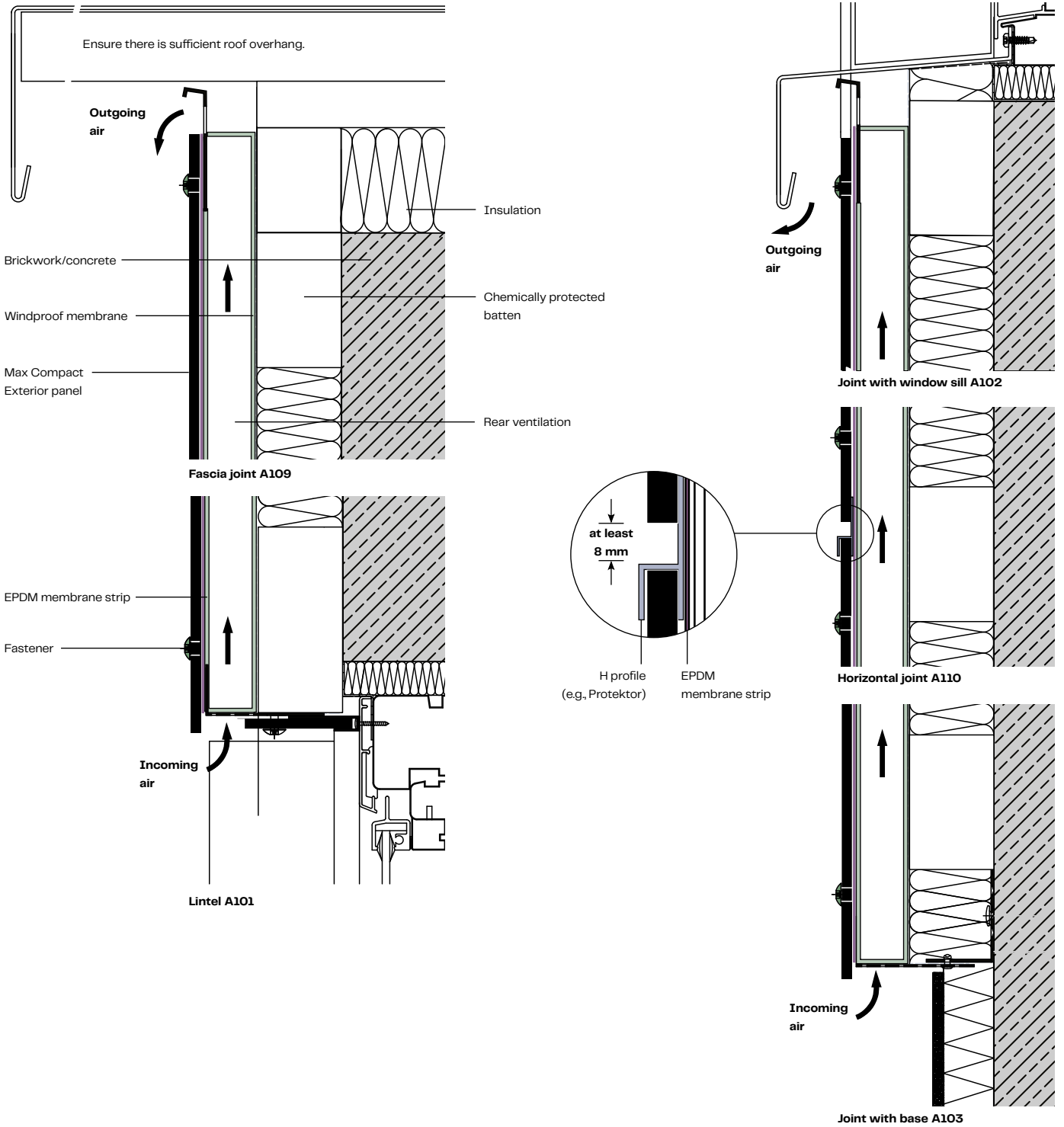

6 Soffits

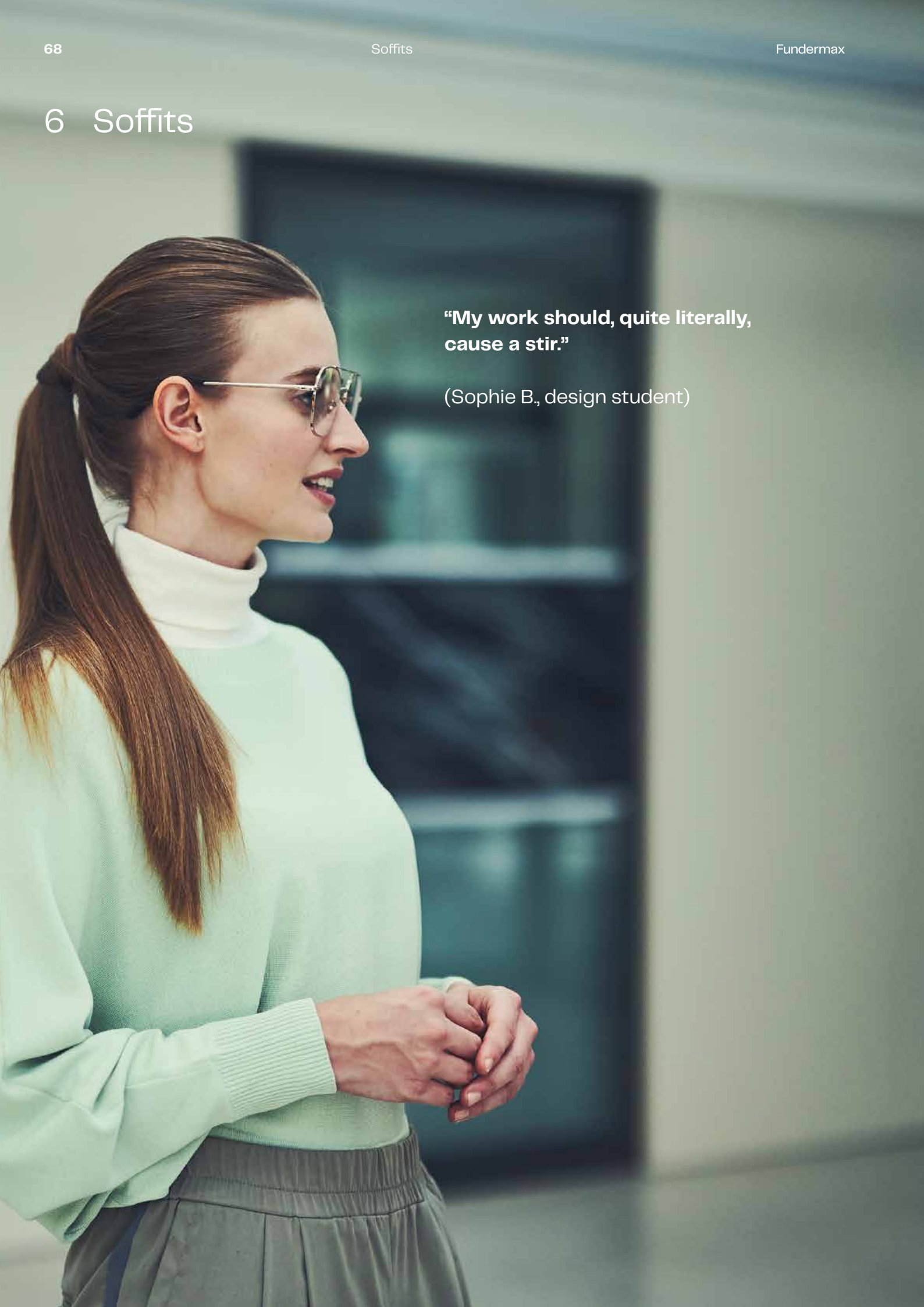

**“My work should, quite literally,
cause a stir.”**

(Sophie B., design student)



Visible Mechanical Fastening with Rivets or Screws

Max Compact Exterior panels can be mounted on an aluminum substructure using rivets, on a timber substructure using screws, or using invisible mechanical fasteners. Please consider the notes on pages 54 to 57. For timber substructures, please take note of national standards (moisture content of wood $15\% \pm 3$) and the need for construction-related or chemical timber protection. An EPDM membrane strip (thickness 1.2 mm) with a ≥ 10.0 mm overhang on all sides is required between the panel and wooden batten. Fit the batten parallel to the direction of air flow.

Clear air cross section for air inlets and outlets ≥ 20.0 mm. Outgoing air goes out through the rear ventilation space of the rainscreen facade. Connections to WDVS facades are only permissible if they include an outgoing air level (construction-related). Fixed and sliding points should be designed into the installation of Max Compact Exterior panels.

Fixed Point

Fixed points serve to evenly distribute (halve) changes in size. The diameter of drill holes in Max Compact Exterior panels corresponds with the diameter of the fastener.

Notes

NG surface: For the best possible look, installation using adhesive on an aluminum substructure is recommended to avoid a wavy overall appearance. For suppliers, see end of the brochure.

Sliding Point

The diameter of the drill hole in the Max Compact Exterior panel must be larger than the diameter of the fastener, depending on the required expansion clearance. The diameter of the drill hole is the shaft diameter of the fastener plus 2.0 mm per meter of cladding material starting from the fixed point. The fastener head must cover the drill hole. Attach fasteners so the panel can move. Do not screw them in too tight. The center of the hole in the substructure must match the center of the hole in the panel. Use a drilling jig. Start fastening the panels at the center of the panel and work outward.

Distance from Edge

Maintain a distance from the edge of 20.0–80.0 mm to ensure stability and flatness. For dimensional changes, panel joints should be at least 8.0 mm (see Fig. 6 01).

Fastener Spacing

Observe relevant structural requirements. If this is not necessary due to local building regulations, see the table on page 69 for values.

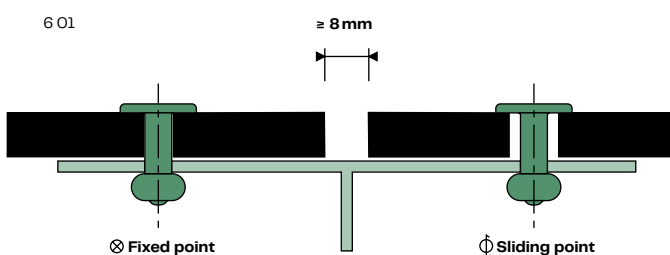

Note:

Gluing soffits is not approved in Germany. Invisible fasteners are a possible alternative, see page 50.

For installation using mechanical fasteners (screws and rivets)

Panel thickness	Max. fastener spacing "b" single span panel	Max. fastener spacing "a" double span panel
6.0 mm	350.0 mm	400.0 mm
8.0 mm	400.0 mm	450.0 mm
10.0 mm	450.0 mm	500.0 mm

Fasteners

Only use fasteners made out of non-corrosive materials.

Max Compact Exterior fastening screw (Fig. 5 37, see page 61):

- With Torx 20 made out of stainless steel X5Cr Ni Mo 17122 material No. 1.4401 V4A
- Lacquered head available on request
- Diameter of the drill hole in Max Compact Exterior for installation using screws: Sliding point 8.0 mm or as required; fixed point 6.0 mm

Aluminum blind rivet (Fig. 5 07, see page 37):

- With large head, color lacquered, for external wall cladding with Max Compact Exterior panels on aluminum substructures
- Rivet sleeve: Material no. EN AW-5019 according to DIN EN 755-2
- Rivet pin: Material no. 1.4541, pull-off strength ≤ 5.6 kN, approved by DIBt Berlin under approval no. Z-10.3-712 for Max Compact Exterior external wall cladding
- Diameter of the drill hole in Max Compact Exterior for installation using rivets: Sliding point 8.5 mm or as required; fixed point 5.1 mm
- Diameter of drill hole in aluminum substructure: 5.1 mm
- Apply rivets using a flexible mouthpiece and corresponding rivet gun

Invisible Mechanical Fastening Using Plate Anchors (see page 50):

- SFS blind fastener TUF-S (ETA-15/O476)
- Hilti S-HPO2SS (ETA-21/O567)
- Please note: Take into account the load capacity of the fastener according to ETA when calculating spacing between fasteners.

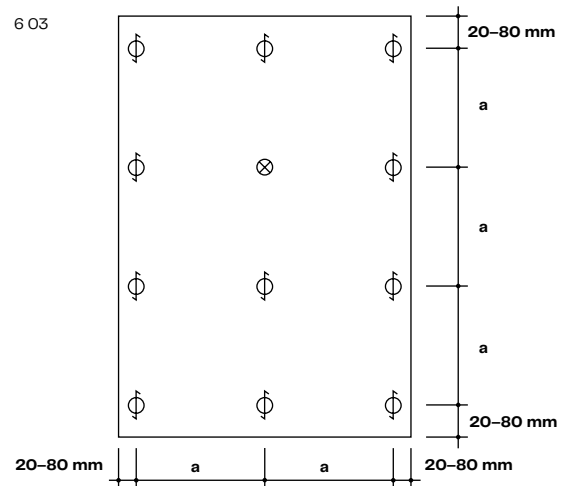
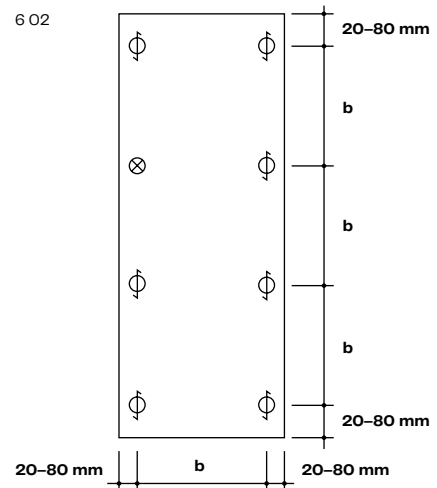

6 01 Example vertical joint
 6 02 Single span panel
 6 03 Double span panel

⊗ Fixed point
 ⊕ Sliding point

Construction Details—Vertical Cross Section Underside Riveted

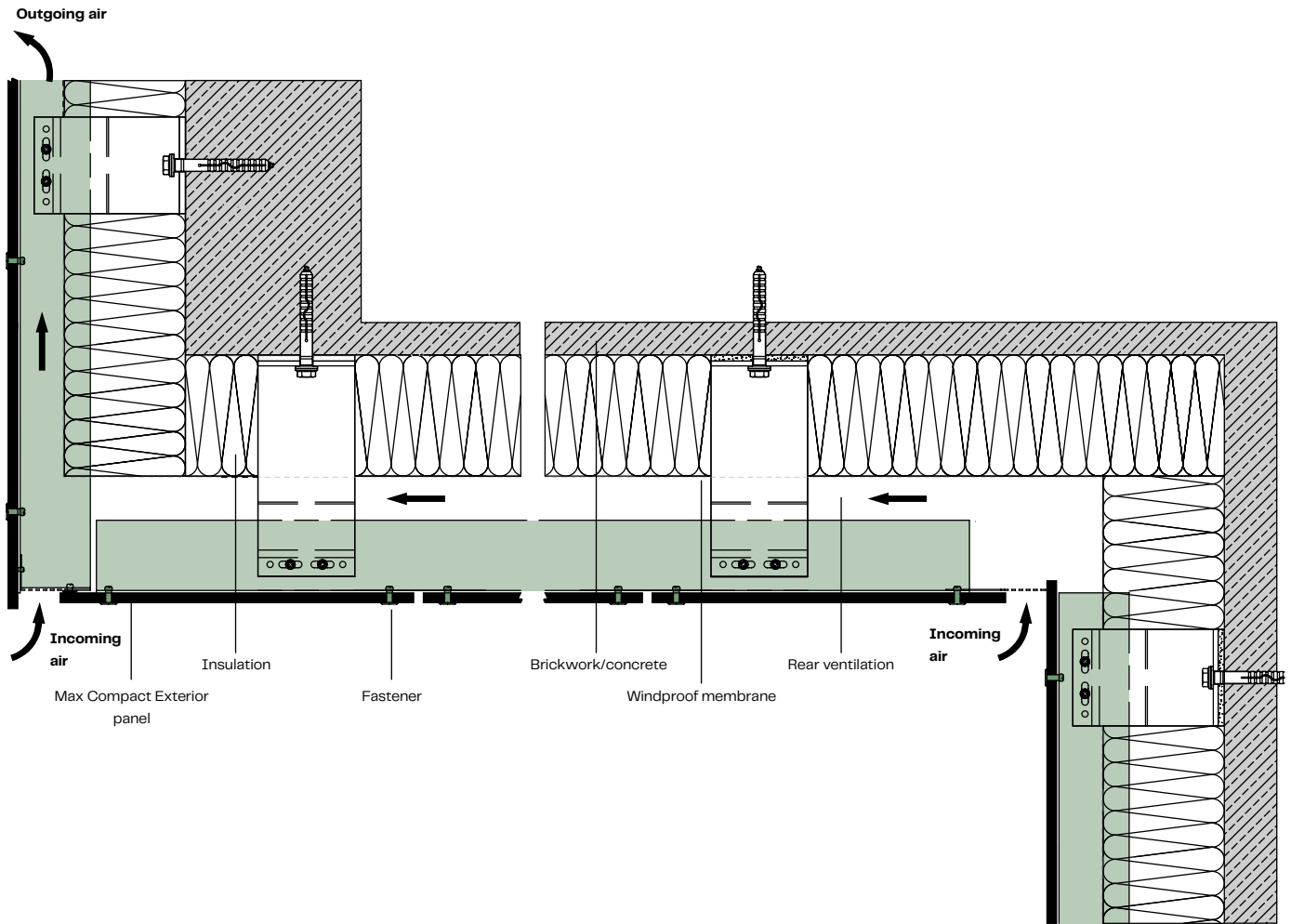

Invisible Fastening Using an Adhesive System

Instead of using visible fasteners, Max Compact Exterior panels can be attached to aluminum substructures using adhesive systems. The stability of the structure must be tested using statics, based on the specific building concerned. The responsible local or national official building inspection bodies must approve this. Due to varying regional building regulations/legislation, additional fastening by means of mechanical fixings (rivets, screws, etc.) may be requested. Gluing should be carried out in accordance with the instructions of the adhesive system manufacturer. Recommendation: Use adhesive systems that are approved by the building authorities for installing rainscreen facades.

Pretreatment of Aluminum Substructures

- Grind with a suitable abrasive fleece in accordance with the adhesive manufacturer's recommendation
- Clean using a suitable cleaning product* from the adhesive manufacturer
- Apply primer according to the adhesive manufacturer's recommendation
- Allow drying time for the cleaning product and primer according to adhesive manufacturer's instructions

Pretreatment of Max Compact Exterior Panels

- Grind with a suitable abrasive fleece in accordance with the adhesive manufacturer's recommendation
- Clean using a suitable cleaning product* from the adhesive manufacturer
- Apply primer according to the adhesive manufacturer's recommendation
- Allow drying time for the cleaning product and primer according to adhesive manufacturer's instructions
- All surfaces to be glued must remain clean, dry, and grease-free

Gluing

- Obtain information from the manufacturer of the adhesive system
- Apply the adhesive strip to the entire length of the vertical profile (do not remove the protection film yet!)
- Apply the glue in a triangle in accordance with the recommendation of the system manufacturer
- Remove the protection film from the adhesive strip
- Press down on the panels in the correct position (installation angle) until the adhesive strip makes contact

*Sika Aktivator-205 activates the panel surface and leaves behind a gray residue. Do not apply to the front side of the panel! Remove splashes immediately!

Adhesive System Manufacturers

- Bostik ETA-22/0675
- PRO PART Klebe Dicht KD 385Z-10.8-453
- Innotec Project System Z-10.8-483

7 Outdoor Furniture

“Great design shouldn’t be hidden away inside.”

(Philippa I., interior designer)



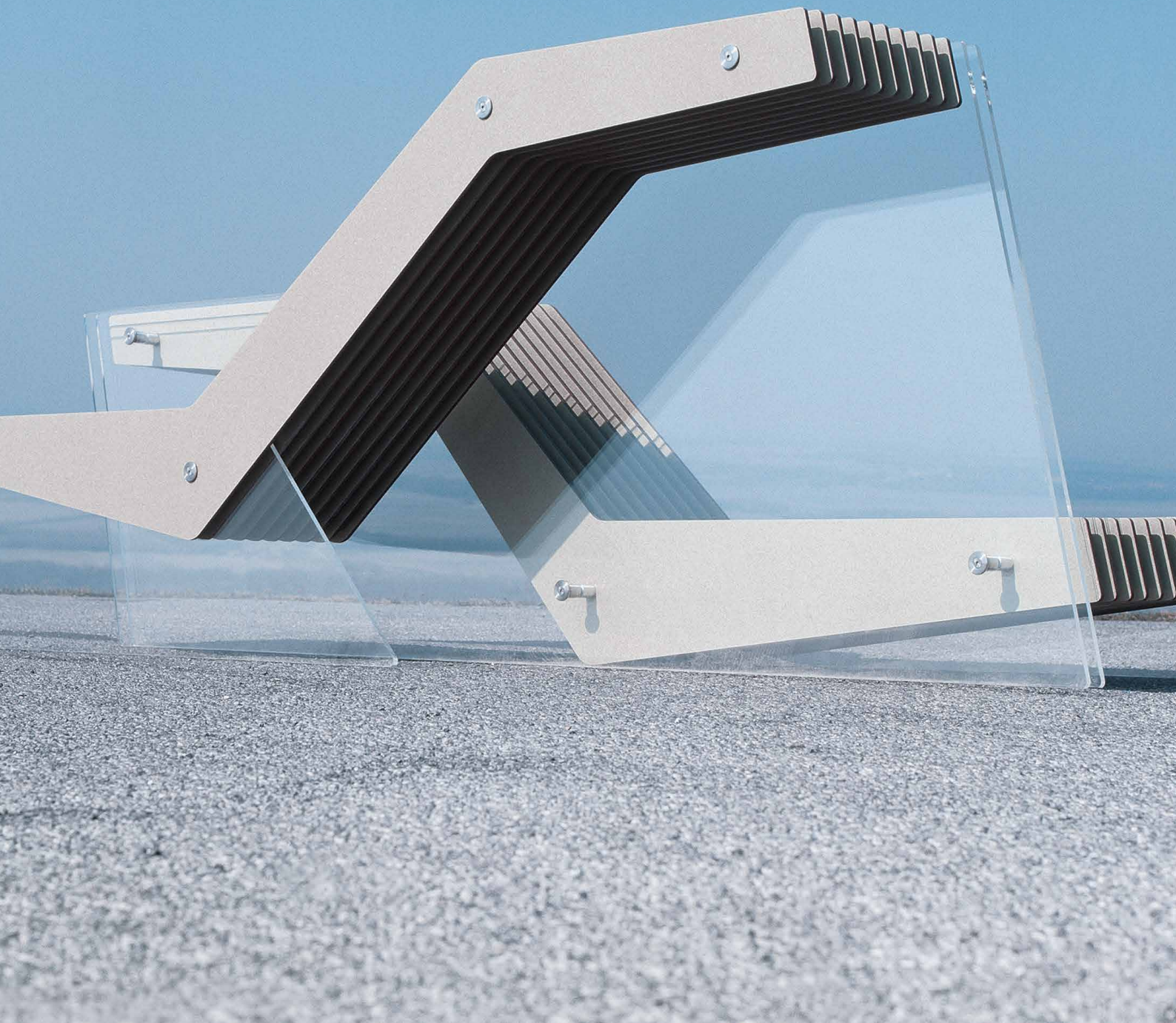

Recommendation for Manufacturing Outdoor F

Application

Max Compact Exterior panels are suitable for use as table tops, benches, or other furniture for outdoor use.

Resistance

The panels have non-porous surfaces, good chemical resistance (easy to clean), and are highly resistant to scratches, abrasion, and impacts.

Storage

Due to their weight, tables should not be stacked, nor should table tops be stored one on top of the other. Protect outdoor furniture from standing water in winter.

Panel Thickness

The panel thickness should be 12.0 mm, or a minimum of 10.0 mm, to provide sufficient depth for screws. The panel thickness, fastener spacing, and expected load capacity are directly linked and should be calculated accordingly.

Installation

Ensure that the installation is unrestricted. Fasten using screws or glue. Screws can be screwed either directly into the panel or via sleeves with external and internal threads (e.g., Rampa sleeves). For this, the panels must be drilled one size smaller to establish a thread. Panels are fastened using screws from the underside. Screws with a metric thread and a flat head are suitable—do not use countersunk screws. If necessary, washers can be used. Only use fasteners made out of non-corrosive materials. Create fastening points as sliding points.

Fastener Spacing

Max Compact Exterior

Thickness (mm)	Fastener spacing (mm)	Overhang (mm)
10.0	320.0	180.0
12.0	400.0	250.0

Sliding Points

Depending on the expansion clearance required, the diameter of the drill hole in the substructure should be larger than the diameter of the fasteners. The screw head should cover the drill hole. Position the fasteners so that the panel can move. The center of the hole in the substructure must match that of the hole in the Max Compact Exterior panel. Drill with a centering aid! Start fastening the panels at the center of the panel and work outward.

7 01 Sliding point Sliding point



Examples when Using Max Compact Exterior Panels of 12.0 mm

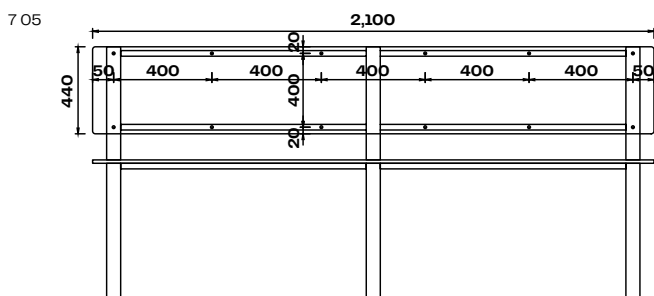
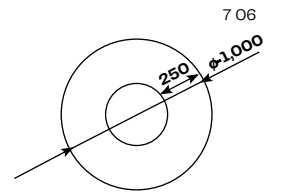
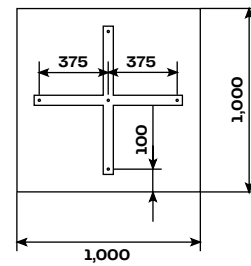
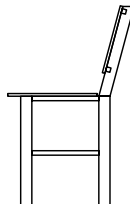
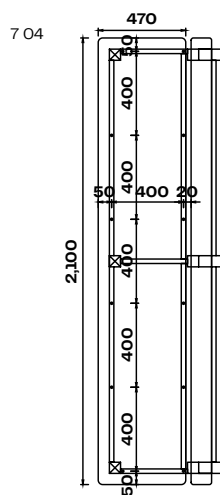
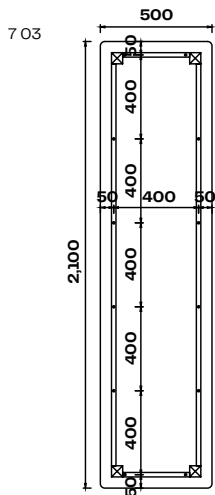
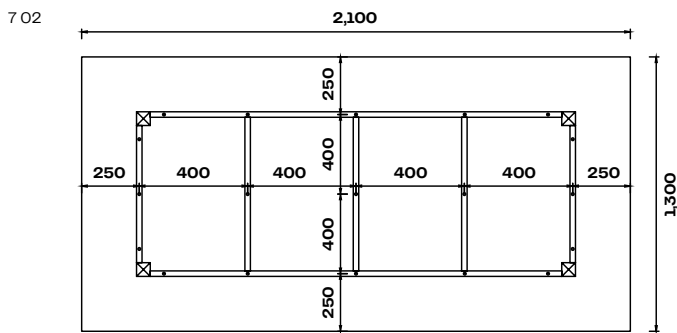

- 7 01 Sliding points
- 7 02 Table application
- 7 03 Bench
- 7 04 Bench with backrest
- 7 05 Bench with backrest
- 7 06 Table top overhangs

8 Balconies and Railings



**“Balconies are details.
But it’s the details that
make the design.”**

(Jonas G., contractor)



General

Max Compact Exterior panels can be fitted in a variety of versions as balcony and railing fillings or fences.

Basics

Protect the material from standing water (panels must be able to dry out). Bonded Max Compact Exterior panels should always be joined in the same running direction. Variations in flatness (see EN 438–6, 5.3) can be offset by stable, level construction of the substructure. All joints with other building elements or the subsurface should be securely closed. Avoid any flexible intermediate layers with the substructure structure and parts of the substructure that have a tolerance of more than ± 0.5 mm. Max Compact Exterior panels can be installed using rivets or screws. Form fixed and sliding points when installing panels (see Fig. 8 03).

Technical Notes

Protect the substructure from corrosion. Be aware of preventing possible contact corrosion when selecting materials. Anchoring elements for affixing to brickwork/concrete or for installing panels must be specified in accordance with typical local wind loads and structural requirements. Evidence of this must be provided by the client. When installing panels, take into account the required expansion clearance according to manufacturer's recommendations.

Sliding Point

The diameter of the drill hole in the Max Compact Exterior panel must be larger than the diameter of the fastener, depending on the required expansion clearance. Shaft diameter of the fastener plus 2.0 mm per meter of cladding material starting from the fixed point. The fastener head must cover the drill hole. Set fasteners so that the panel can move. Position rivets centrally using a flexible mouthpiece. The spacing of the rivet heads on the surface of the panel (0.3 mm) allows for movement of the parts in the drill hole (see Fig. 8 09, page 84).

The center of the drill hole in the substructure should match the one on the Max Compact Exterior panel—use a drilling jig! Start fastening the panels at the center of the panel and work outward.

Expansion Point

As an option, an expansion point can be added to each panel. For details, see page 36.

Fixed Point

Fixed points serve to evenly distribute (halve) changes in size. The diameter of the drill hole in the Max Compact Exterior panel should be the same size as the diameter of the fastener.

Panel Joints

To ensure that dimensional changes can be made without restriction, make sure joints are at least 8.0 mm wide.

Combining Decorative Finishes

For a consistently light design for balcony interiors, Max Compact Exterior panels can also be made with a white (reverse) side (O890 NT – Balkonweiss). The combination of different decorative laminates means the specified mounting distances should be reduced by at least 15%.

Balcony Corners

For renovations involving very uneven substructures in particular, it is important for the front panel to protrude about 10.0 mm in front of the side panel. That will cover the construction tolerances of the main visible sides.

8 01

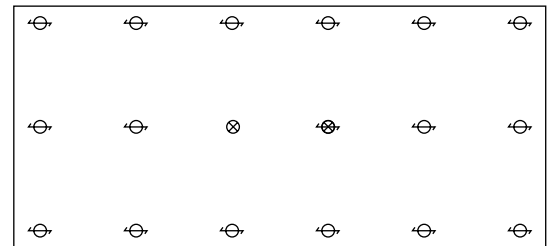

8 02

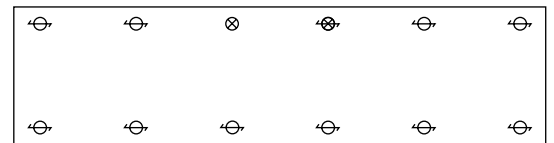

⊗ Fixed point

○ Sliding point

⊕ Expansion point

8 03

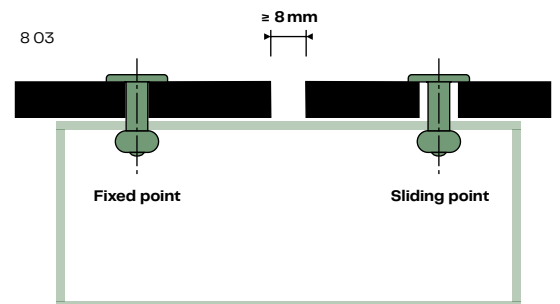

8 04

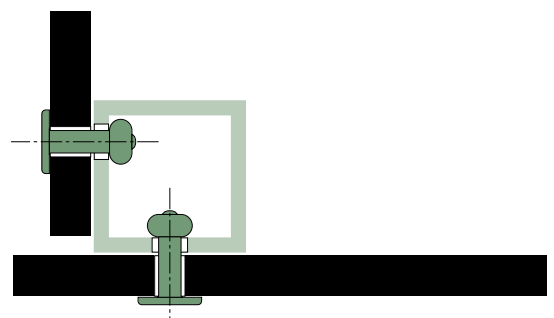

- 8 01 Double span panel
- 8 02 Single span panel
- 8 03 Minimum joint / fixed and sliding point
- 8 04 Balcony corner

Balcony Fasteners

As a basic principle, only use fasteners made out of non-corrosive materials.

Max Compact Exterior balcony screw (A2):

- Blank head, lacquer possible
- Washer between the Max panel and polyamide substructure
- Diameter of the drill hole in the Max Compact Exterior panel: Sliding point 8.5 mm or as required; fixed point 6.0 mm
- Diameter of the drill hole in the substructure: Installation hole 6.0 mm or according to the sleeve size
- Screw length = clamping thickness + ≥ 9.0 mm

Aluminum blind rivet:

- With large head, color lacquered, for aluminum substructures
- Rivet sleeve: Material no. EN AW-5019 according to DIN EN 755-2
- Rivet pin: Material no. 1.4541, pull-off strength ≤ 5.6 kN

Niro/ Niro blind rivet:

- With large head, color lacquered, for steel substructures
- Rivet sleeve: Material no. 1.4567 (A2)
- Rivet pin: Material no. 1.4541 (A2), pull-off strength ≤ 5.8 kN
- Diameter of the drill hole in the Max Compact Exterior panel: Sliding point 8.5 mm or as required; fixed point 5.1 mm
- Diameter of drill hole in metal substructure: 5.1 mm
- Steel or stainless steel substructure: Use Niro/Niro blind rivets

Glass clamp holder:

Can also be used for installation. Apply one lock pin per panel element (protects against falling by easing the clamping on the panels).

Apply rivets using a flexible mouthpiece (0.3 mm allowance).

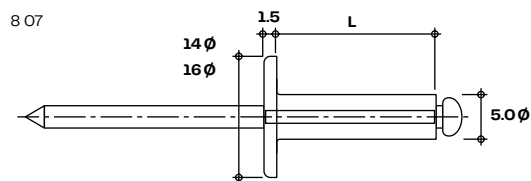
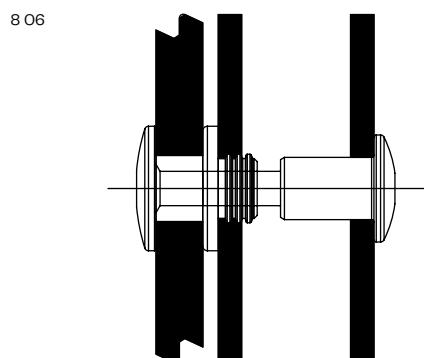
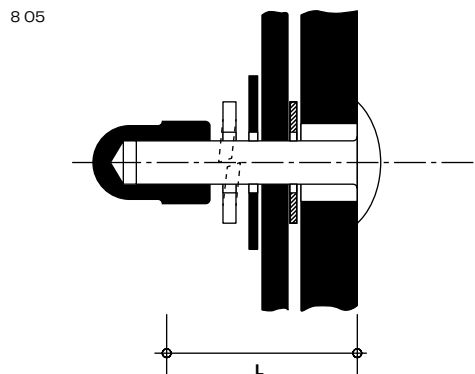

8 08

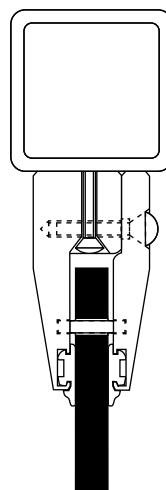

8 09

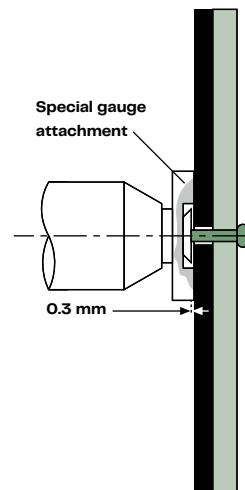

Fastening Diagram for Railing Structures

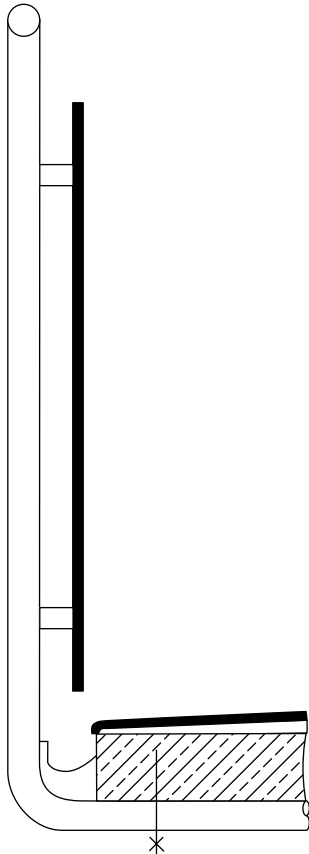

810

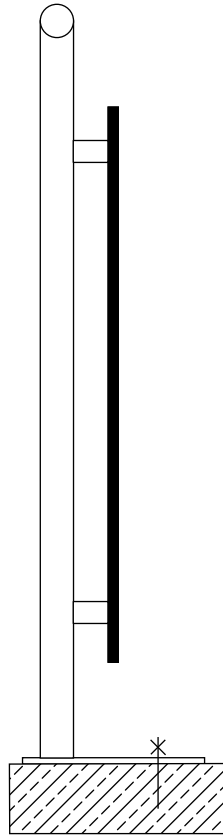

811

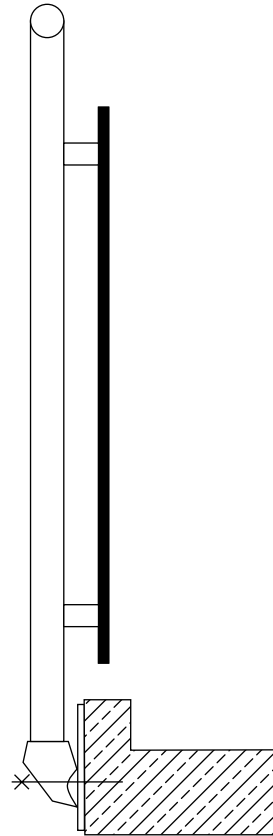

812

The height of the railings is measured from the upper edge of the concrete, as this is considered to be the main surface.

x = fastening screws according to structural requirements

- 8 05** Balcony screw
- 8 06** Balcony screw version
- 8 07** Blind rivet with large head
- 8 08** Glass clamp holder
- 8 09** Special gauge attachment (allowance 0,3 mm)
- 8 10** Fastening beneath the concrete panel
- 8 11** Fastening onto the concrete panel
- 8 12** Fastening onto the front side of the concrete panel

Fastening and Edge Distance Options

Riveted Max Compact Exterior Panel (Riveted Version, Page 82)

The railing installation options shown here were tested by MPA Hannover in accordance with ETB guidelines for "securing components against falls, July 1985 edition" and passed.

$F1 \leq 120.0 \text{ mm}$

$F2 \leq 40.0 \text{ mm}$

Clear overhangs E1:

- For 6.0 mm panels: $20.0 \text{ mm} \leq E1 \leq 120.0 \text{ mm}$
- For 8.0 mm panels: $20.0 \text{ mm} \leq E1 \leq 200.0 \text{ mm}$
- For 10.0 mm panels: $20.0 \text{ mm} \leq E1 \leq 250.0 \text{ mm}$

Clear overhangs E2:

- For 6.0 to 10.0 mm panels: $20.0 \text{ mm} \leq E2 \leq 80.0 \text{ mm}$

Panel thickness	Railing height* $H = 900.0\text{--}1,100.0 \text{ mm} =$ max. fastener spacing
6.0 mm	A $\leq 350.0 \text{ mm}$ L $\leq 800.0 \text{ mm}$
8.0 mm	A $\leq 350.0 \text{ mm}$ L $\leq 950.0 \text{ mm}$
10.0 mm	A $\leq 400.0 \text{ mm}$ L $\leq 1,000.0 \text{ mm}$

* Set railing height according to local building regulations, e.g., OIB guideline 4 – Safety in use and accessibility. High safety barrier: min. 100.0 cm, from a fall height of over 12.0 m (measured from the floor) min. 110.0 cm.



Ketzergasse balcony

8 13

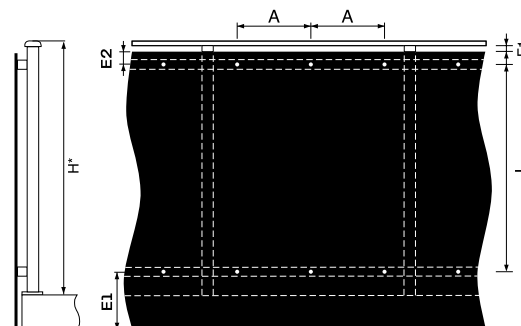

8 14

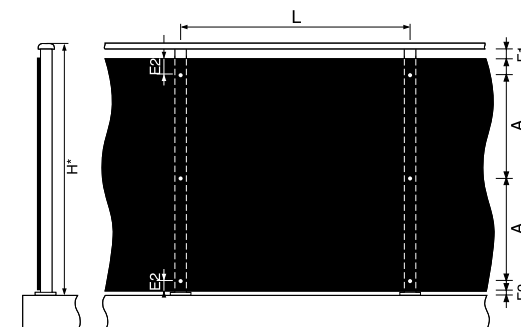

Screwed Max Compact Exterior Panel (Balcony Screw, Page 82)

F1 ≤ 120.0 mm

F2 ≤ 40.0 mm

Clear overhangs E1:

- For 6.0 mm panels: 20.0 mm ≤ E1 ≤ 120.0 mm
- For 8.0 mm panels: 20.0 mm ≤ E1 ≤ 200.0 mm
- For 10.0 mm panels: 20.0 mm ≤ E1 ≤ 250.0 mm

Clear overhangs E2:

- For 6.0 to 10.0 mm panels: 20.0 mm ≤ E2 ≤ 80.0 mm

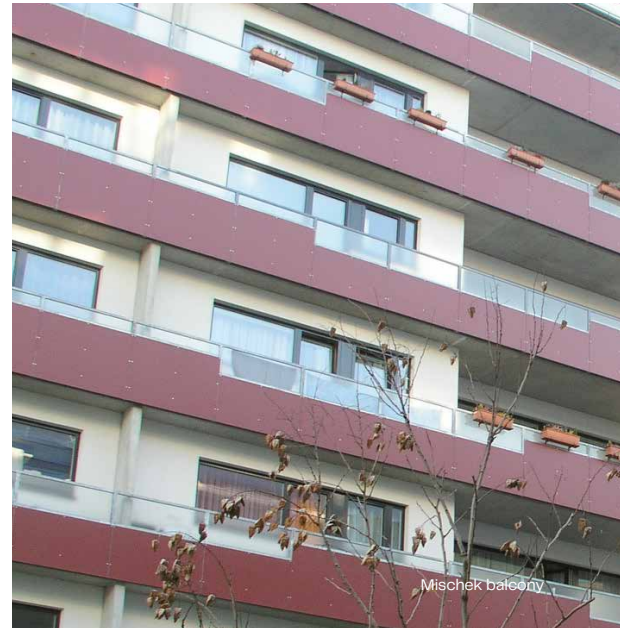

8 15

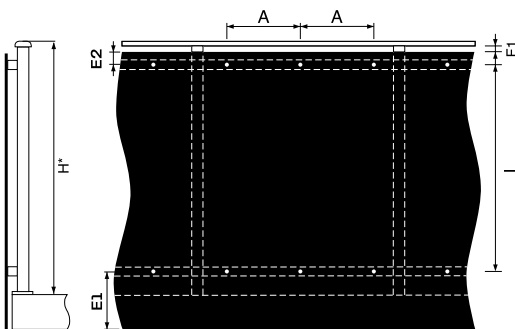

Panel thickness	Railing height* H = 900.0–1,100.0 mm = max. fastener spacing
6.0 mm	A ≤ 450.0 mm L ≤ 850.0 mm
8.0 mm	A ≤ 500.0 mm L ≤ 1,000.0 mm
10.0 mm	A ≤ 550.0 mm L ≤ 1,100.0 mm

* Set railing height according to local building regulations, e.g., OIB guideline 4 – Safety in use and accessibility. High safety barrier: min. 100.0 cm, from a fall height of over 12.0 m (measured from the floor) min. 110.0 cm.

8 16

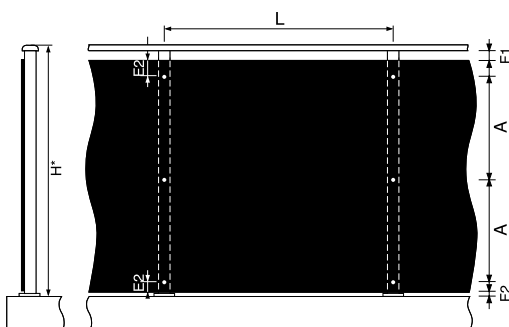

- 8 13 Horizontal rivet fastening
- 8 14 Vertical rivet fastening
- 8 15 Horizontal balcony screw fastening
- 8 16 Vertical balcony screw fastening

Max Compact Exterior Panels with Aluminum Frames—Attached, Dimensions According to Structural Requirements

$F1 \leq 120.0$ mm

$F2 \leq 40.0$ mm

$B \geq 1,300.0$ mm = part length

$P \geq 28.0$ mm internal profile depth

$D \geq 8.0$ mm expansion leeway

Ensure the profiles can drain and prevent waterlogging.

Panel thickness	Railing height* $H = 900.0\text{--}1,100.0$ mm = max. fastener spacing
6.0 mm	A ≤ 950.0 mm
8.0 mm	A $\leq 1,150.0$ mm

* Set railing height according to local building regulations, e.g., OIB guideline 4 – Safety in use and accessibility. High safety barrier: min. 100.0 cm, from a fall height of over 12.0 m (measured from the floor) min. 110.0 cm.



8 17

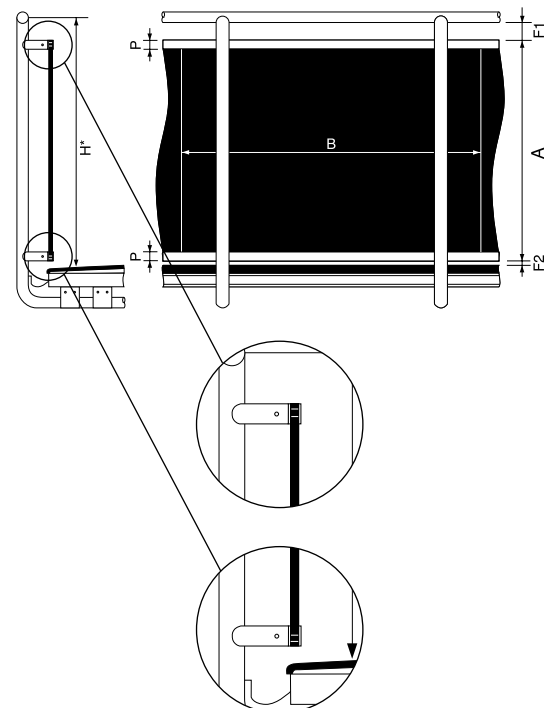

Perforated Max Compact Exterior Panel, Riveted (Riveted Version, Page 82)

Arrange center distances in a square pitch (see Fig. 8 18).

$F1 \leq 120.0 \text{ mm}$

$F2 \leq 40.0 \text{ mm}$

Clear overhangs E1:

- For 10.0 mm panels: $20.0 \text{ mm} \leq E1 \leq 250.0 \text{ mm}$

Clear overhangs E2:

- For 6.0 to 10.0 mm panels: $20.0 \text{ mm} \leq E2 \leq 80.0 \text{ mm}$

Panel thickness	Railing height* $H = 900.0\text{--}1,100.0 \text{ mm} = \text{max. fastener spacing}$
10.0 mm	A $\leq 350.0 \text{ mm}$
	L $\leq 840.0 \text{ mm}$

* Set railing height according to local building regulations, e.g., OIB guideline 4 – Safety in use and accessibility. High safety barrier: min. 100.0 cm, from a fall height of over 12.0 m (measured from the floor) min. 110.0 cm.

Recommended hole pattern

D	Diameter	$\leq 40.0 \text{ mm}$
G	Hole spacing	min. 30.0 mm
H	Hole center spacing	min. 70.0 mm

8 18

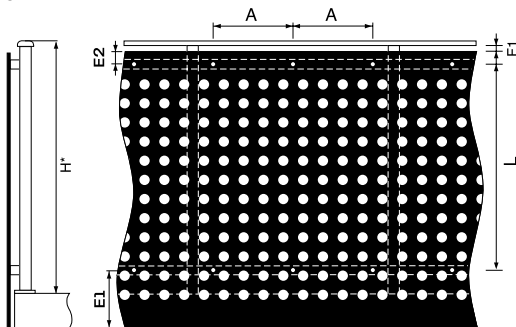

8 19

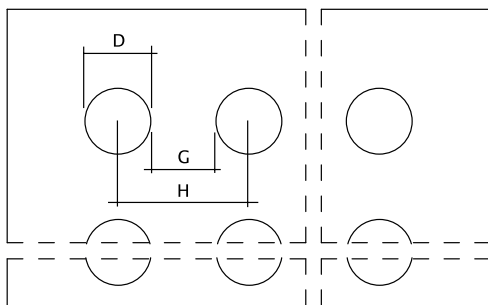

8 17 Fastening using frames

8 18 Fastening using rivets / perforated Max Compact Exterior panel

8 19 Recommended hole pattern



8 20

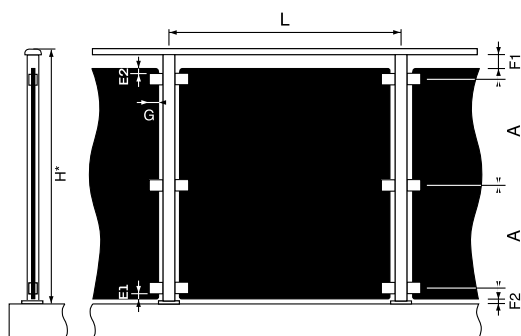

Max Compact Exterior Panels Attached Using Clamping

Profiles (Glass Holders)

$F1 \leq 120.0 \text{ mm}$

$F2 \leq 40.0 \text{ mm}$

$G \leq 35.0 \text{ mm}$

Clear overhangs E1:

- For 6.0 mm panels: $20.0 \text{ mm} \leq E1 \leq 120.0 \text{ mm}$
- For 8.0 mm panels: $20.0 \text{ mm} \leq E1 \leq 160.0 \text{ mm}$
- For 10.0 mm panels: $20.0 \text{ mm} \leq E1 \leq 200.0 \text{ mm}$

Clear overhangs E2:

- For 6.0 to 10.0 mm panels: $20.0 \text{ mm} \leq E2 \leq 80.0 \text{ mm}$

Arrange min. 3 fastening points per side. Apply one clamp holder with a lock pin per panel element.

Panel thickness **Railing height***
H = 900.0–1,100.0 mm =
max. fastener spacing

8.0 mm	A	$\leq 450.0 \text{ mm}$
	L	$\leq 950.0 \text{ mm}$
10.0 mm	A	$\leq 500.0 \text{ mm}$
	L	$\leq 1,100.0 \text{ mm}$
13.0 mm	A	$\leq 550.0 \text{ mm}$
	L	$\leq 1,150.0 \text{ mm}$

* Set railing height according to local building regulations, e.g., OIB guideline 4 – Safety in use and accessibility. High safety barrier: min. 100.0 cm, from a fall height of over 12.0 m (measured from the floor) min. 110.0 cm.



Balcony with glass holders

8 21

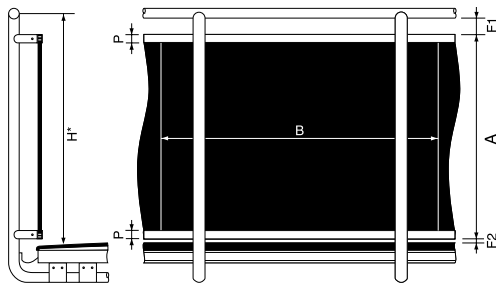

Curved Balconies with Max Compact Exterior Panels and Metal Frames (Dimensions According to Structural Requirements)

Upper and lower frame profiles (2.0 mm thick) need to be pre-curved. Only sliding linear fasteners are permissible (no point fixings). Apply edging to ends and panel joints as well (U profile, H profile).

Radius min. 3.0 mm

F1 ≤ 120.0 mm

F2 ≤ 40.0 mm

B ≤ 1,300.0 mm = part length

P ≥ 28.0 mm internal profile depth

8 22

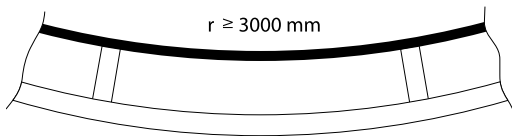

Ensure the profiles can drain and prevent waterlogging.

Panel thickness	Railing height*
6.0 mm	H = 900.0–1,100.0 mm = max. fastener spacing
	A ≤ 1,000.0 mm

* Set railing height according to local building regulations, e.g. OIB guideline 4 – Safety in use and accessibility. High safety barrier: min. 100.0 cm, from a fall height of over 12.0 m (measured from the floor) min. 110.0 cm.



8 20 Fastening using glass holders (clamp profiles)

8 21 Fastening using frames

8 22 Minimum radius of curved balconies

Basics of Surrounding Structures

These should be factored in for buildings where children will be present to ensure functionality and protection against climbing. Designs expected to feature openings must comply with local building regulations.

Austria

OIB-RL 4.1.3/ÖNORM B 5371 Point 12:

- Max. horizontal opening width: 12.0 cm
- Max. vertical opening width: 2.0 cm

Germany

DIN 18065: 2001-01/State Building Regulations:

- Max. horizontal opening width for bar constructions: 12.0 cm
- Max. vertical opening width: 2.0 cm
- Diagonal dimension for horizontal board or bar constructions and lattice constructions: 4.0 cm

Switzerland

SIA standard 358/BFU Beratungsstelle für Unfallverhütung brochure [advice for accident prevention]:

- For GF 1, openings in the protective elements must not have a diameter larger than 12.0 cm up to a height of 75.0 cm. Prevent climbing with measures such as ensuring the gap in horizontal crossbars (openings) is only 1.0–3.0 cm.
- Grid-like hole drilling: Max. 4.0 cm opening width
- Round holes: Max. 5.0 cm opening width

Notes

For project-specific deviations, please contact the relevant building authority.

Balcony Divider Panels

General

Max Compact Exterior divider panels are used to partition off individual sections of elongated balconies or passageways. The panels are placed perpendicular to the outer wall of the building and affixed in a variety of ways. Depending on the design of the outer edge of the balcony surface, the panels extend to the lower edge of the ceiling of the next story down in the building. Affix to continuous profiles or plates. Design the hollow substructure according to structural calculations and affix to the reinforced concrete slabs using approved anchor bolts or other mounting parts. Profiles must act as structurally load-bearing supports. Max Compact Exterior F panels should be fastened with the same fasteners as railing panels. Privacy screen elements must be attached via at least 3 fastening points on each side.

Load table for single span panels/wind load* Max Compact Exterior panels riveted onto aluminum substructure

Panel thickness	6.0 mm		8.0 mm		10.0 mm	
Load q (kN/m ²)	max. B (mm)	max. A (mm)	max. B (mm)	max. A (mm)	max. B (mm)	max. A (mm)
Germany/Austria/Switzerland						
0.50	600.0	600.0	700.0	700.0	800.0	800.0
1.00	600.0	431.0	700.0	539.0	800.0	551.0
1.50	600.0	311.0	700.0	373.0	800.0	455.0
2.00	537.0	261.0	700.0	280.0	800.0	337.0

Values refer to DIN 1055-T4 or DIN 18516 and approval Z-10.3-712.

Load table for double span panels/wind load* Max Compact Exterior panels riveted onto aluminum substructure

Panel thickness	6.0 mm		8.0 mm		10.0 mm	
Load q (kN/m ²)	max. B (mm)	max. A (mm)	max. B (mm)	max. A (mm)	max. B (mm)	max. A (mm)
Germany/Austria/Switzerland						
0.50	600.0	600.0	700.0	700.0	800.0	800.0
1.00	600.0	373.0	700.0	400.0	800.0	420.0
1.50	600.0	249.0	700.0	320.0	800.0	280.0
2.00	537.0	208.0	700.0	240.0	800.0	210.0

Values refer to DIN 1055-T4 or DIN 18516 and approval Z-10.3-712.

Clear overhangs E:

- For 6.0 mm panels: 20.0 mm ≤ E ≤ 80.0 mm
- For 8.0 mm panels: 20.0 mm ≤ E ≤ 80.0 mm
- For 10.0 mm panels: 20.0 mm ≤ E ≤ 80.0 mm
- F ≥ 8.0 mm
- G: 20.0–30.0 mm

Notes

Make sure you opt for different fastener spacings if the balcony divider panels are being used as a fall protection. You will find these in the “Balconies and Railings” section.

* Calculation tables for a wind load range of between 0.3 kN/m² and 2.6 kN/m² are available from the Fundermax support team on request.

8 23

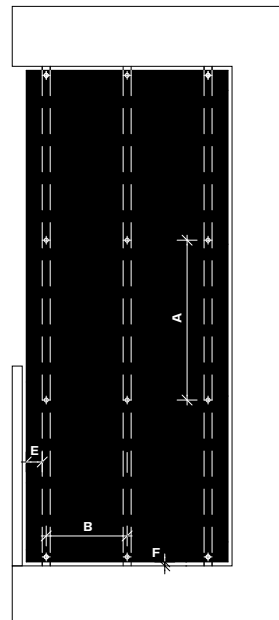

8 24

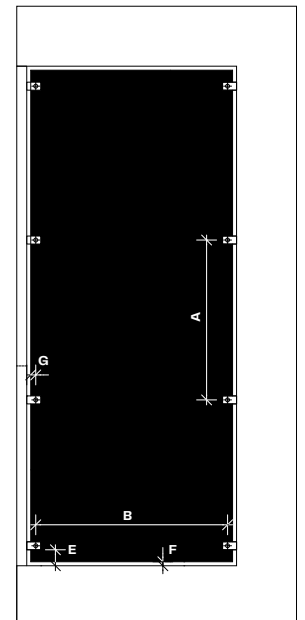

9 Podio Balcony Floor Panels



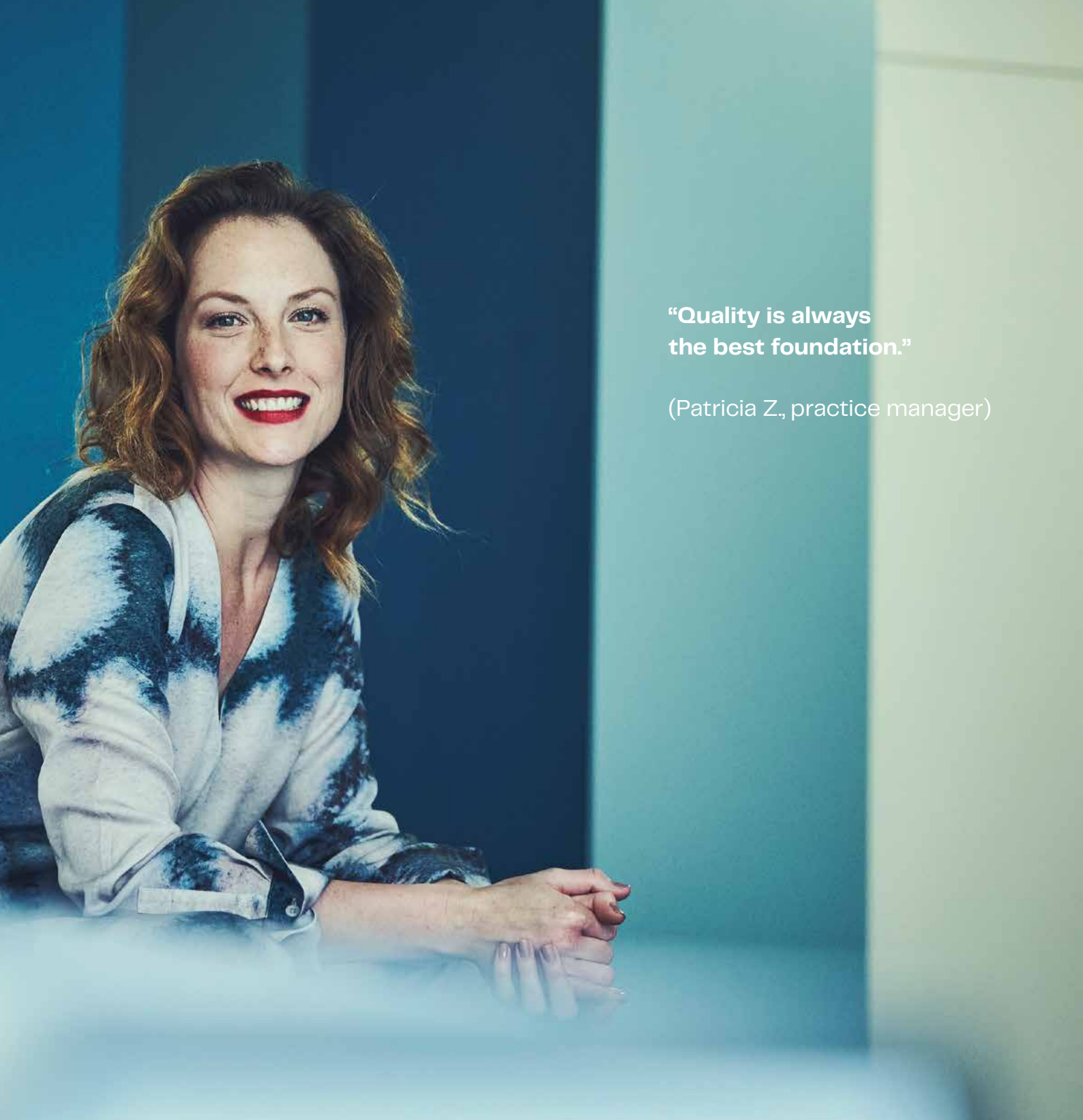

**“Quality is always
the best foundation.”**

(Patricia Z., practice manager)

Podio (Max Compact Exterior) Balcony Floor Panels

Description of Materials

This balcony floor panel is a high-quality construction product bearing the CE label and a non-slip hexagon surface, suitable for balconies, steps, and platforms.

Max Compact Exterior panels are thermoset high-pressure laminates (HPL) that meet the requirements of EN 438-6, type EDF, and offer effective weather protection thanks to dual-cure acrylic polyurethane resin. They are produced in laminate compactors at a high temperature and pressure.

Surfaces

- Top: NH-Hexa
- Underside: NT



Decorative Laminates

Two-sided: See current Max Compact Exterior collection or www.fundermax.com

Anti-Slip Gradings

- R10 in accordance with DIN 51130
- Group C in accordance with DIN 51097

Sizes

- XL = 4,100.0 x 1,854.0 mm = 7.6 m²
- X2 = 2,050.0 x 1,854.0 mm = 3.8 m²
- GR = 2,800.0 x 1,300.0 mm = 3.64 m²
- GR sizes = 2,800.0 x 1,300.0 mm = 3.64 m² and X2 = 2,050.0 x 1,854.0 mm = 3.8 m² are only available in 6 stock colors.
- Tolerances +10.0–0.0 mm (EN 438-6, 5.3)
- Panel sizes are standard sizes. For dimensional and angle accuracy, cutting all sides is recommended. Depending on the cut, the net measurement reduces by approx. 10.0 mm.

Core

- F-Quality, flame retardant, brown color

Thicknesses (According to Structural Requirements)

Thickness	Tolerance (EN 438-6, 5.3)
• 16.0 mm	± 0.7 mm
• 18.0 mm	± 0.7 mm
• 20.0 mm	± 0.7 mm

Approval—General Certification

Design certifications:

No. Z-50.4-337

Fire resistance testing:

REI60 according to EN 13501-2 for a thickness of 20.0 mm and use in building classes 4 and 5

Design

Local building regulations must be observed. For horizontal installation only.

9 01

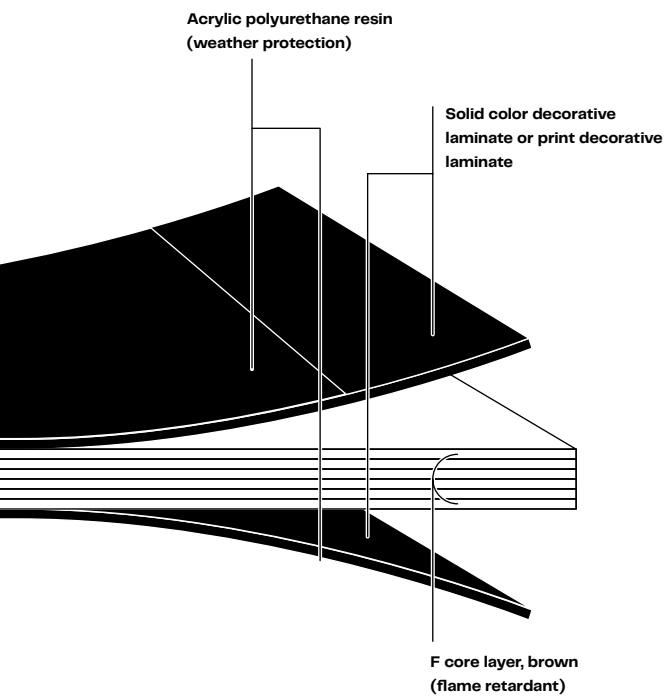

9 01 Composition of balcony floor panels
 9 02 Vertical cross section—principle of rear ventilation and gradient

9 02

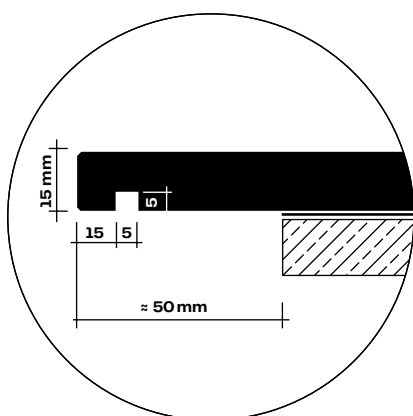

Basics of Handling

Podio balcony floor panels can be attached to suitable substructures in various ways, with gradients, using screws or adhesive. The subsurface and substructure need to be structurally capable of supporting sufficient load. Make sure there is rear ventilation with a minimum 25.0 mm gap above the subsurface. Moisture-retaining subsurfaces (grass, gravel, shingle, etc.) are unsuitable. Ensure there is enough drainage in the subsurface.

Protect material from standing water—panels must be able to dry out. In general, balconies should have a gradient of $\geq 2\%$. Ensure a suitable amount of expansion clearance. Panel joints must be a at least 8.0 mm. For substructures that run parallel to butt joints, arrange panel joints over the substructure and possibly keep them on the same level using suitable connections. Avoid any flexible intermediate layers with the substructure, and between the parts of the substructure that have a tolerance of more than ± 0.5 mm.

When affixing to a timber substructure using screws, use fixed and sliding points (see pages 60 and 61). Design a timber substructure that meets national standards (timber moisture content $15\% \pm 3$). Ensure construction-related and/or chemical timber protection. Make sure there is appropriate rear ventilation to condition the panels on both sides. Refrain from laying the full surface on the subsurface. Protect the substructure from corrosion.

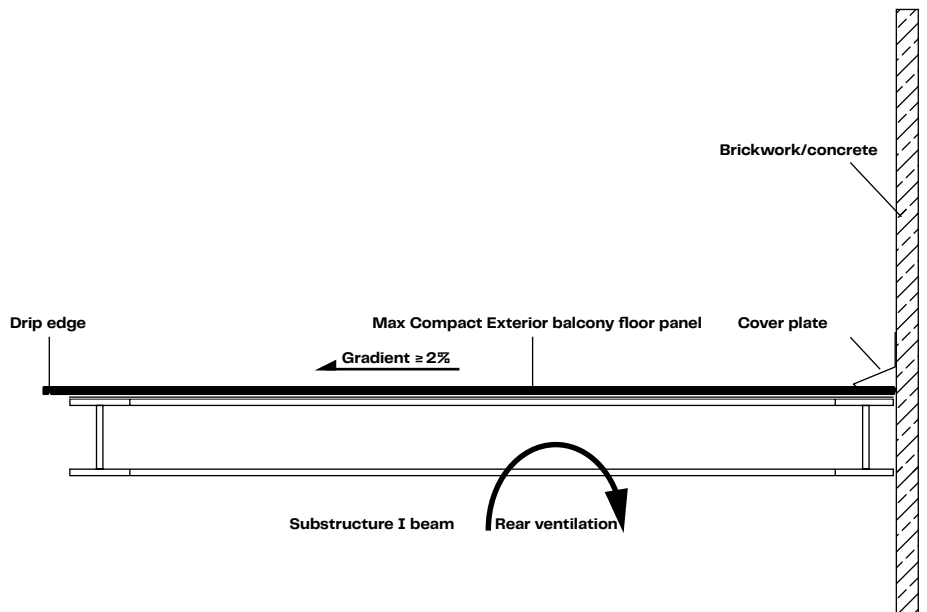

Installation Guidelines

Fastener Spacing

Substructure strips must have a width of ≥ 60.0 mm, or ≥ 80.0 mm around joints. For timber substructures, it should be ≥ 100.0 mm around joints. Distance B should be \leq distance A (support/beam), but never greater than 600.0 mm.

Distance from Edge

When installing using screws, the distance from the edge should be 20.0 mm–100.0 mm.

Panel Joints and Forming Joints

To allow dimensional changes to occur without restriction, joints should be at least 8.0 mm wide. Joints should be filled with a permanently flexible sealant. Place permanently flexible plastic tape under joints.

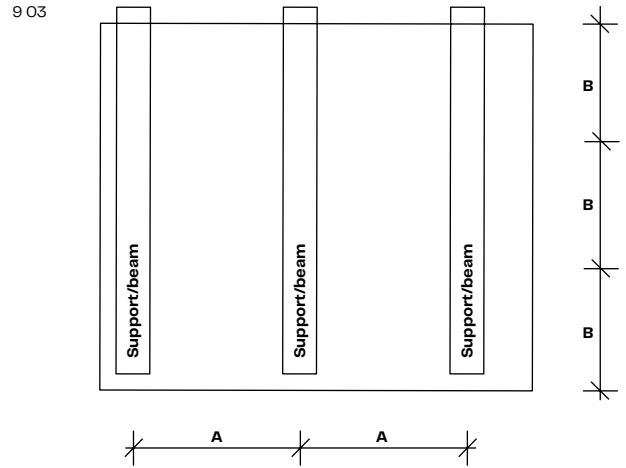

9 03 Substructure spacings

Live load (kN/m²)

max. permissible sag 1/300 kN/m ²	3.0	4.0	5.0
Panel thickness	Support distances in mm		
	A ≤ 500.0 Austria/Germany/Switzerland		
16.0 mm	X	X	X
18.0 mm	X	X	X
20.0 mm	X	X	X
	A ≤ 600.0 Austria/Germany/Switzerland		
16.0 mm	X	X	-
18.0 mm	X	X	X
20.0 mm	X	X	X
	A ≤ 800.0 Austria/Switzerland		
20.0 mm	X	X	-

x = permissible
For applications that are necessary for approval in Germany, maximum spacing of beams in accordance with general building regulation approval Z-50.4-377 should be observed. Find current approvals at www.fundermax.com.



Substructure



Gradients and panel joints



Gradients, external corners, and edges

Installing Podio Balcony Floor Panels— Invisible Mechanical Fastening

9 04

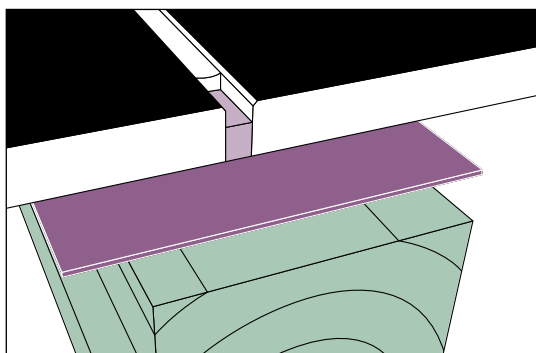

Fixed Point

Fixed points serve to evenly distribute (halve) changes in size. The drill hole diameter in Max Compact Exterior panels should be one channel depth smaller than the diameter of the screw.

Sliding Point

Based on the expansion clearance required, the diameter of the drill hole in the substructure should be larger than the diameter of the fasteners. Shaft diameter of the fastener plus 2 mm per meter of cladding material starting from the fixed point. Attach fasteners so the panel can move. Do not screw them in too tight. Do not use countersunk screws. The center of the hole in the substructure must match the center of the hole in the panels. Use a centering aid (drilling jig). Start fastening the panels at the center of the panel and work outward.

Notes

For timber substructures, please take note of the need for construction-related or chemical timber protection. Use an EPDM strip with a thickness of at least 1.2 mm.

For flawlessly sealed joints, using expansion joint filler is recommended.

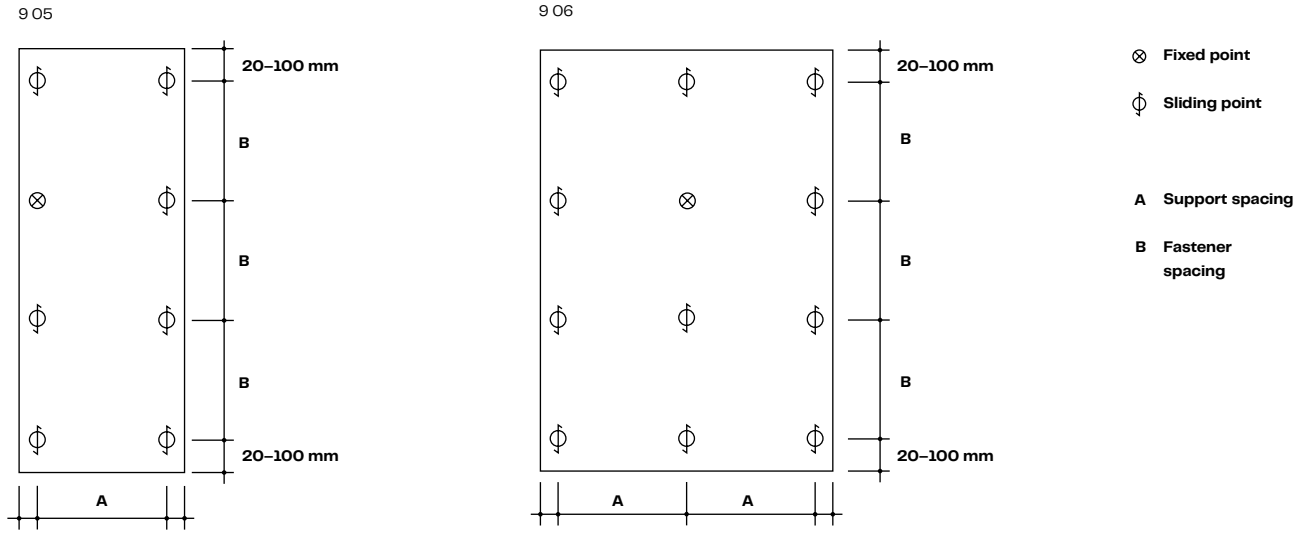

- 9 04 Balcony floor and wooden block
- 9 05 Single span panel
- 9 06 Double span panel
- 9 07 Balcony floor panel on wooden block with invisible fastening using Rampa sleeves (screwed)
- 9 08 Balcony floor panel on steel beams with invisible fastening using Rampa sleeves (screwed)

Installing Podio Balcony Floor Panels Using an Adhesive System

9 09

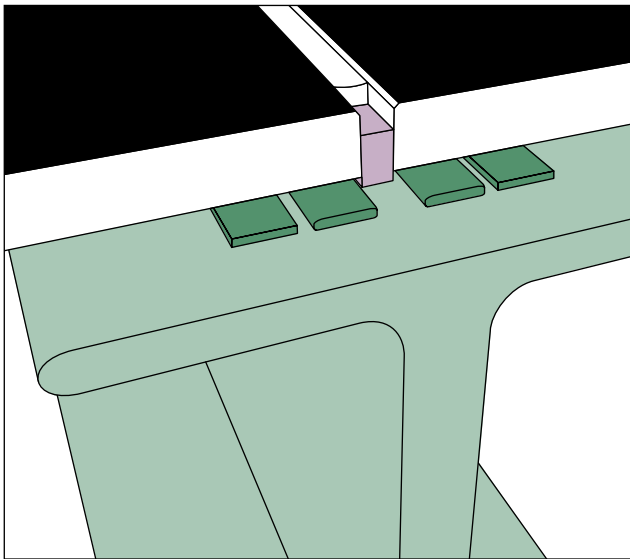

Gluing

Alternative to mechanical fastening: Gluing using specially designed adhesive systems from Pro Part or Innotec. These work on standard metal substructures.

Notes

Ensure fastening is unrestricted. Take into account the expansion and shrinkage behavior of Max Compact Exterior panels. Gluing does not have building regulation approval in Germany.

Find out the maximum panel size from the approval of the adhesive manufacturer. Installation guidelines can be found in the approval of the relevant adhesive system (notes and process information can also be found in the "Invisible Glued Fastening Using an Adhesive System" section).

Gluing balcony floor panels is not approved in Germany.

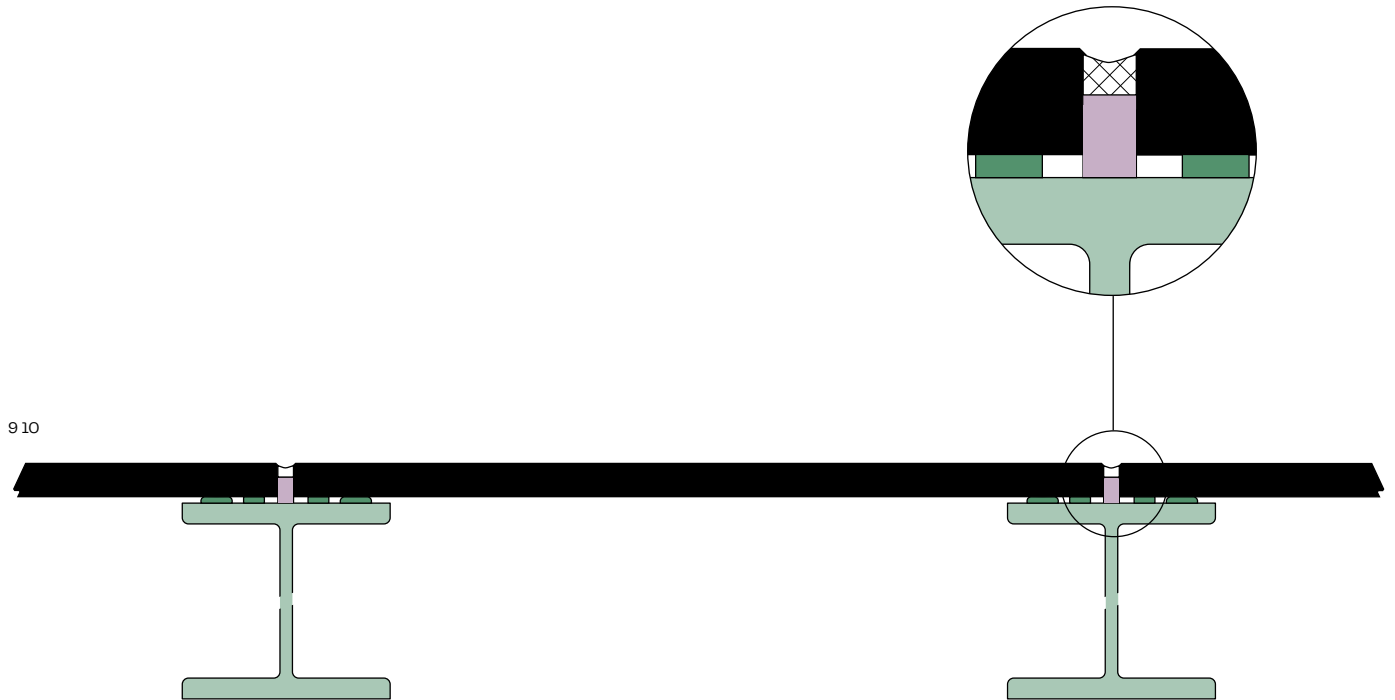



9 10

9 09 Balcony floor panel glued onto steel beams

9 10 Cross section of joints between balcony floor panels

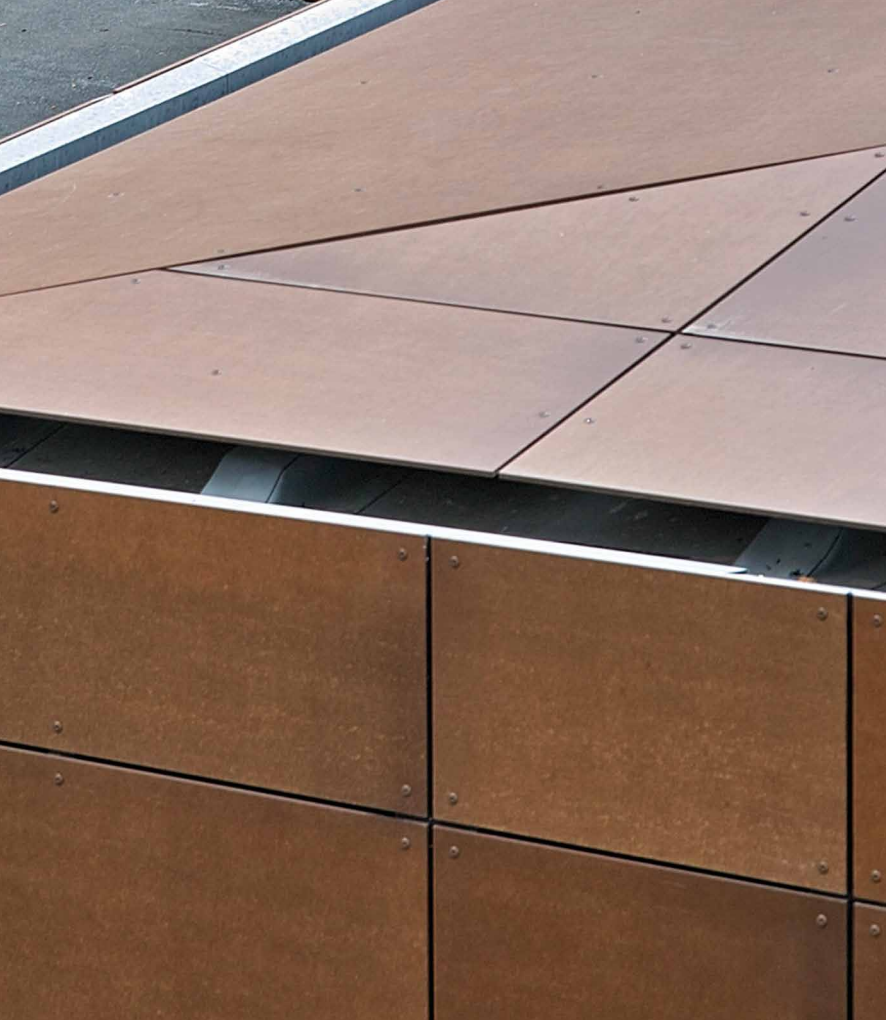
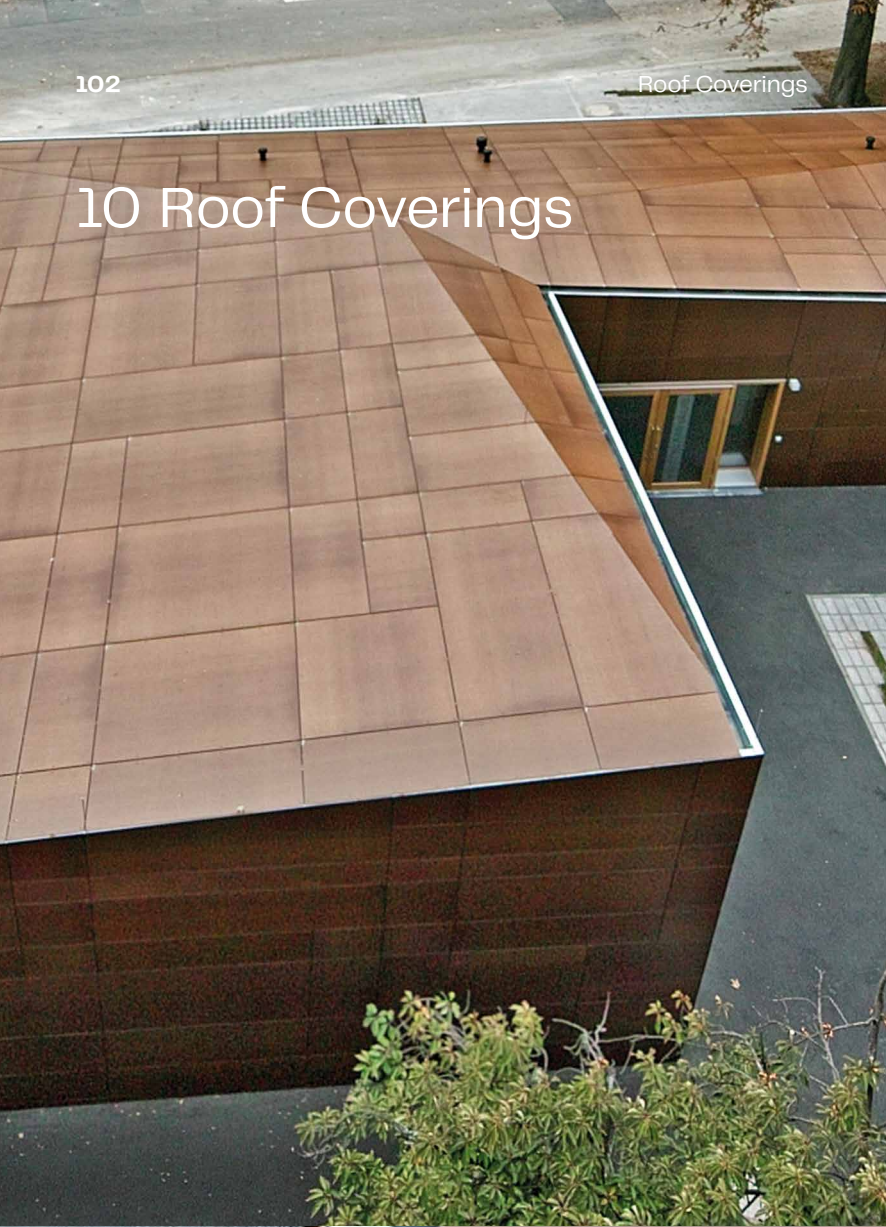
10 Roof Coverings



A man with short, light brown hair and blue eyes is shown from the chest up. He is wearing a dark blue jacket with a subtle red and white plaid pattern over a dark blue button-down shirt. His hands are clasped together in front of him, and he is looking slightly upwards and to the right with a thoughtful expression. The background is a blurred, modern architectural interior with white and grey structural elements.

**“It's no coincidence
that roofs are closest
to heaven.”**

(Hannes K., architect)

General

A trend that is likely to gain ground in future is offering construction options that allow the use of a product both on the facade and as a roof covering. Design and planning should be carefully considered, especially in terms of detailed connections. Elements of the supporting structure, along with decorative panel materials, lend buildings character. By reducing the outer shell to essential visual areas, the observer's eye is drawn to shape and color. The advantages of a rainscreen facade also apply to roof coverings: design, technology, and cost-effectiveness.

Construction Design

Max Compact Exterior can be used for ventilated roof structures if the following requirement is taken into account: The roof pitch must be at least 6°.

Fire Requirements

Fire requirements must be complied with, taking into account regional building regulations, and determined on a project-by-project basis.

Verification of Stability

Stability should be verified on a project-by-project basis for all applications on facades and roof coverings, taking into account regional building regulations.

Wind Load

Snow and wind loads should be taken into account for fasteners and spacing in the substructure:

Austria: Eurocode ÖNORM EN 1991-1-4

Germany: DIN EN 1991-1-4

Ventilation

The ventilation between the membrane and the covering (high degree of counterbattening) depends on the rafter length and roof pitch.

Membrane

The membrane should be installed as a seamless aquiferous layer for all roof pitches and construction options. Drainage occurs through the facade substructure.

Substructure

Depending on planning, the construction design consists of horizontal or vertical support frames and counterbattening attached to the supporting structure. Timber substructures cannot be used for roof applications.

Battens (Batten Profiles)

Vertical or horizontal metal support frames. Single profiles as medium support and double profiles near joints (facilitates drainage).

Joints between Components

Manufacture skylights, air inlets and outlets, etc. with the appropriate sheet metal flashing. Cladding material: Product classification B-s2, d0 in accordance with EN 13501-1

Panel Fastening

Attach roof cladding panels to support profiles using non-corrosive blind rivets. Determine fastener spacing based on the building concerned.

Fixed Point and Sliding Point

Attaching Max Compact Exterior panels to support frames requires sliding and fixed point installation.

Holes in Cladding Panels

Use a drill hole diameter of 5.1 mm for fixed points and 8.5 mm or as required for sliding points. Place rivets centrally using a flexible mouthpiece.

Holes in the Support Frame

Holes of 5.1 mm in the support frame should be positioned centrally in relation to the drill hole in the cladding material.

Fastening the Support Frames

Support frames are attached by means of suitable screws or rivets depending on the design of the counterbattening.

Staining

Avoid soiling caused during construction, higher roof surfaces, and separate drainage.

Details of Roof Construction with Max Compact Exterior Panels

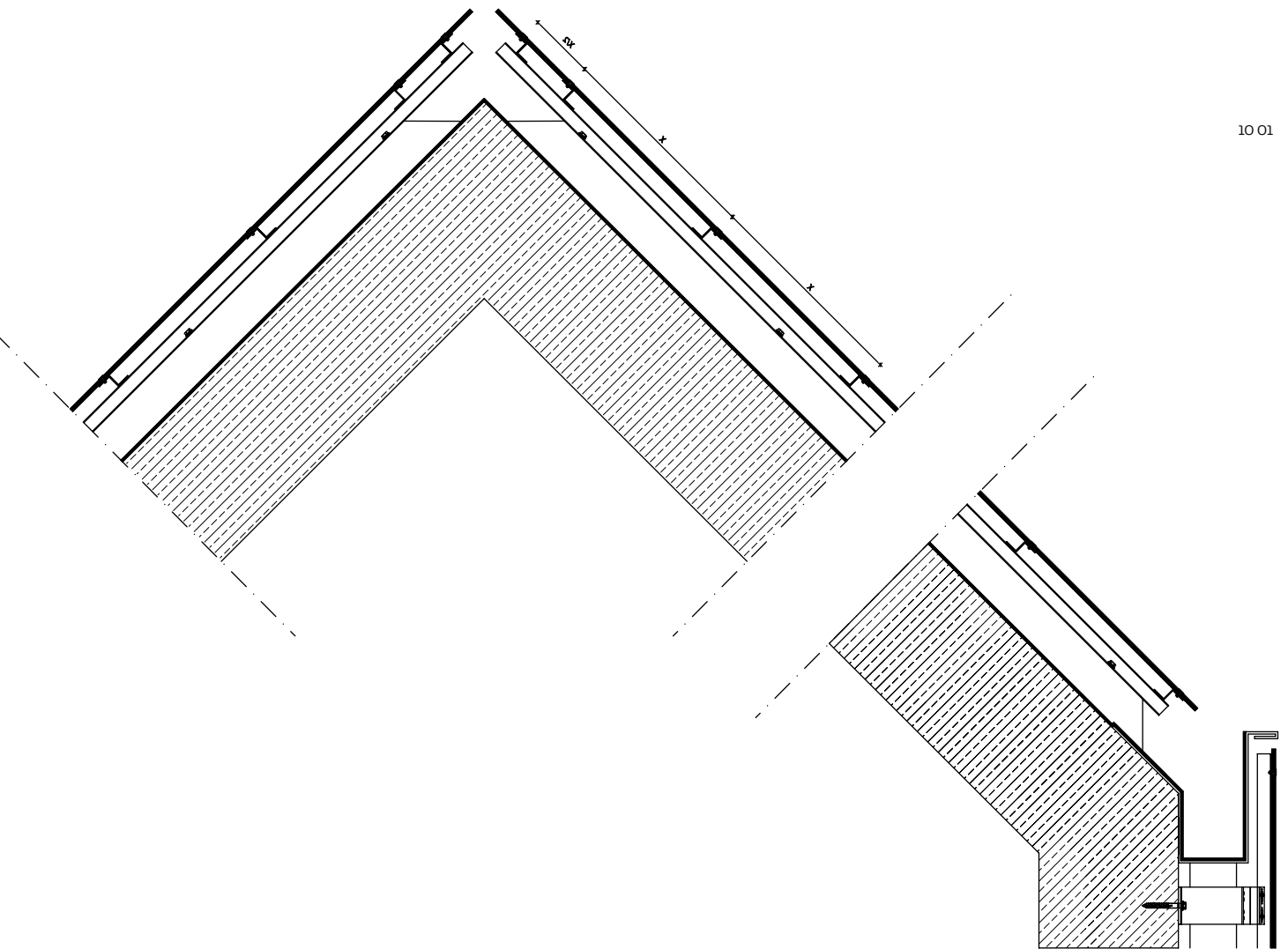

10 01 Vertical cross section: Ridge, roof construction

10 02 Vertical cross section: Roof construction

10 03 Vertical cross section: Verge

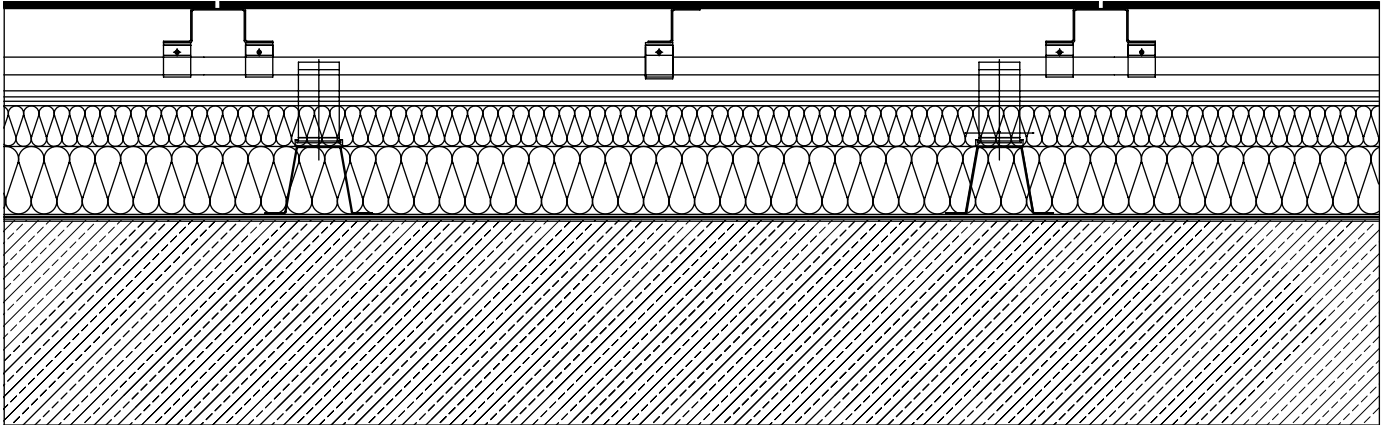

10 02

10 03

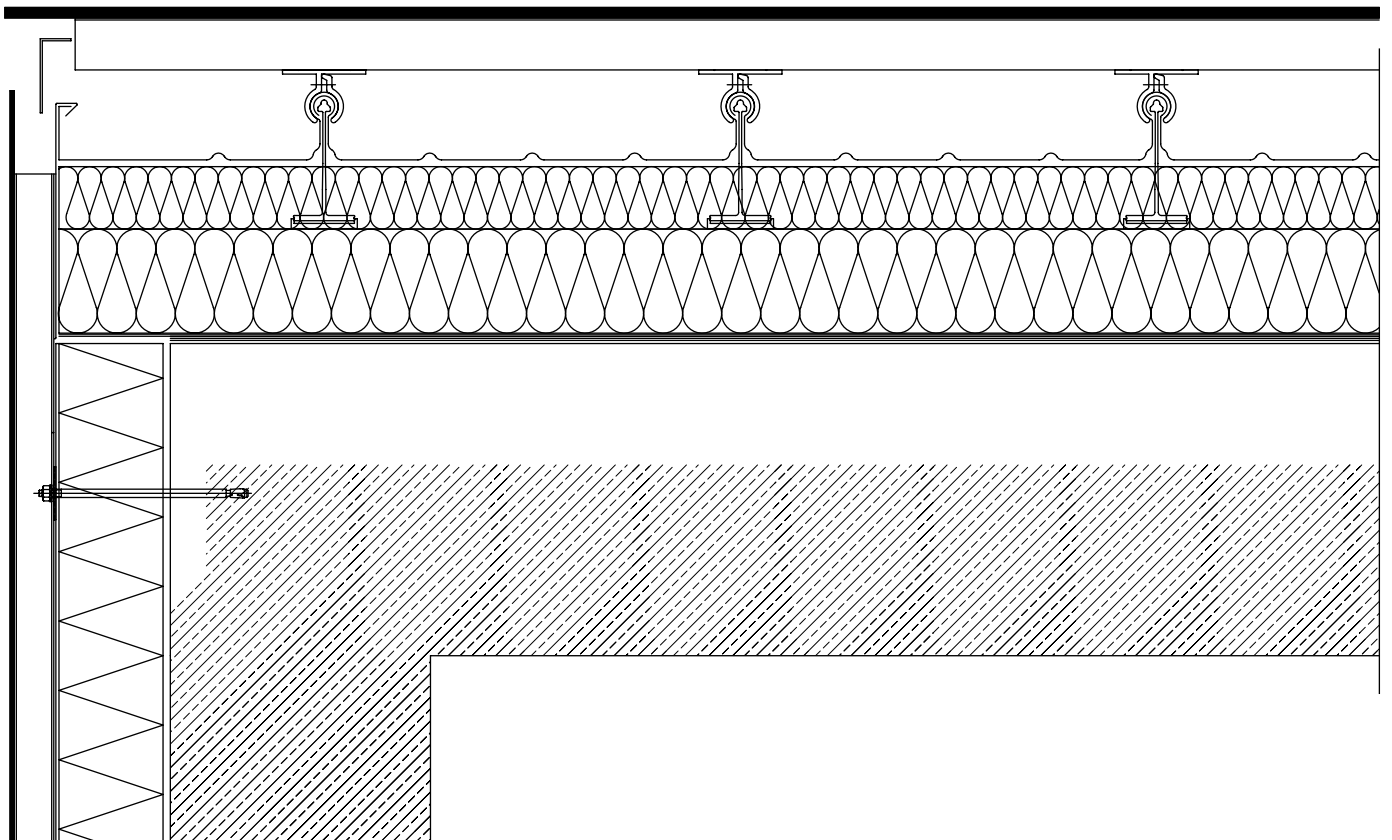

11 Sun Protection



“My dream house should throw everything else in the shade.”

(Bettina F., entrepreneur)



General Guidelines

Max Compact Exterior panels (material thickness of between 8.0 and 15.0 mm) can be used as external sunshades. Minimum width: 10.0 mm. Every element should have two fasteners on at least two sides. Fastener spacing near the panel edge:

> 20.0 mm. Unrestricted installation of elements using fixed and sliding points plus expansion joints of > 8.0 mm with adjacent components. Ensure rear ventilation. Full-surface covering and gluing are inadvisable for this material.

The most common application of Max Compact Exterior panels is for sunshades, installed horizontally and usually slightly angled in front of windows. The maximum number of fastening points depends on the panel thickness, wind load, and fastening angle. See manufacturers on page 112.

Maximum Fastener Spacing for Sunshades

Spacing applies for low wind loads. In the case of higher wind loads, fastener spacing should be determined based on the specific building concerned. If panels are framed or have metal profiles on the sides or back, the spacings listed below can be increased depending on additional stability.

Max Compact Exterior panels: Installation as slats—Fastener spacing

Panel thickness (in mm)	Panel length (in mm)	Change of shape (in mm)
8.0	≤ 1,000.0	3.0
10.0	≤ 1,100.0	3.6
12.0	≤ 1,200.0	3.6

11 01



Sun Protection Elements, Supporting Width $\leq 1,200.0$ mm

11 02

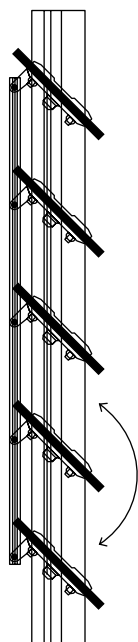

11 03

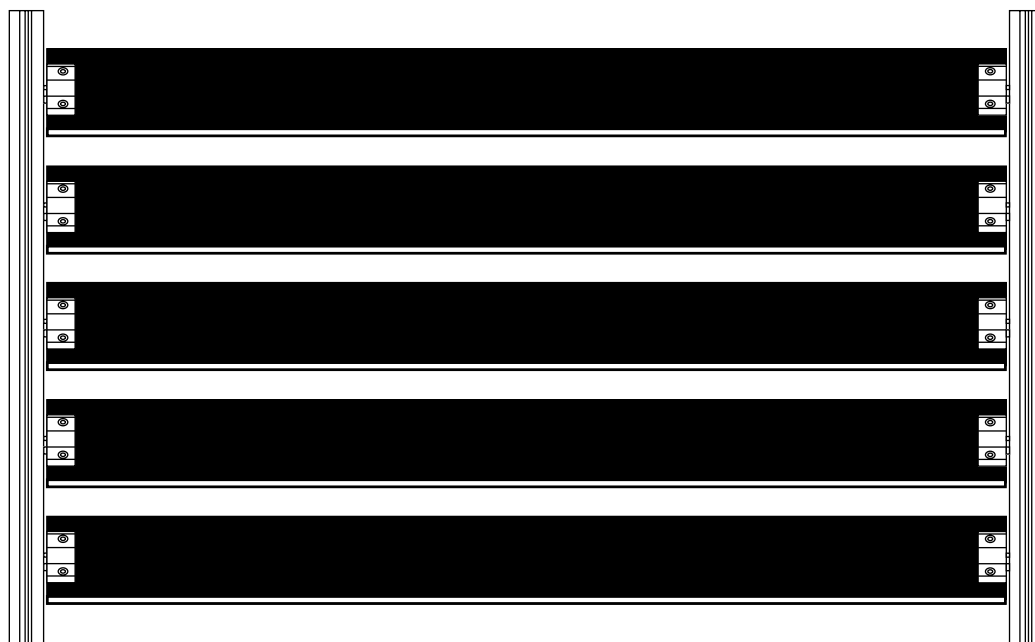

11 04

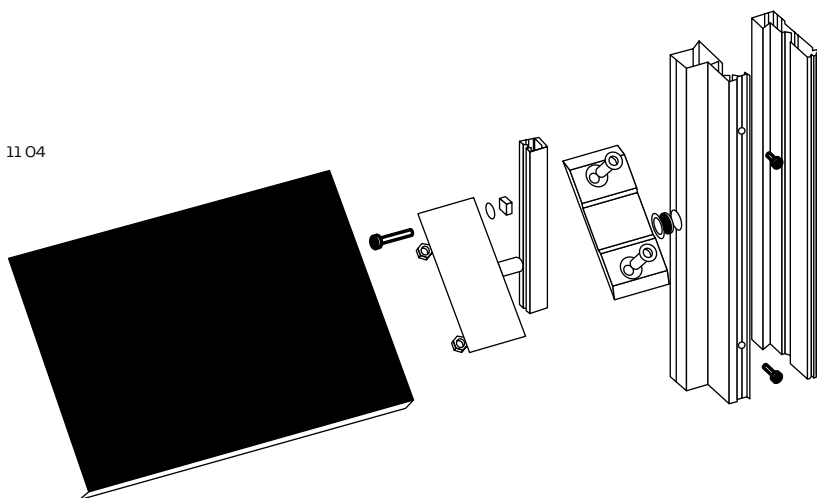

- 11 02 Adjustable sunshades (side view)
- 11 03 Adjustable sunshades (rear view)
- 11 04 Sunshade fastening details
- 11 05 Adjustable/supported sunshades (side view)
- 11 06 Adjustable/supported sunshades (front view)
- 11 07 Installation using supports
- 11 08 Fastening using support frame
- 11 09 Fastening using H profile
- 11 10 Fastening details using support frame

Supported Sun Protection Elements, Supporting Width ≤ 1,200.0 mm

11 05

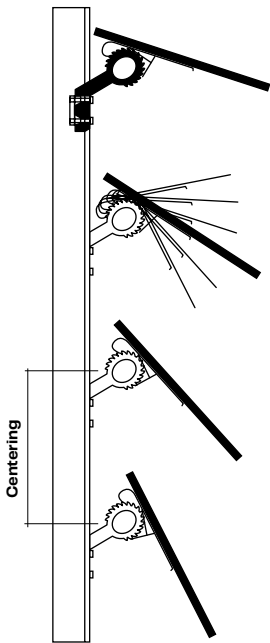

11 06



11 07

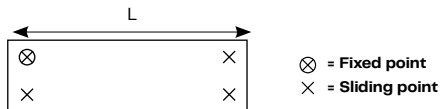

Installation using 2 supports

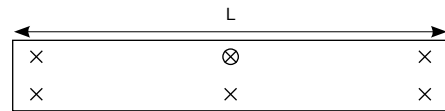

Installation using 3 or more supports

11 08

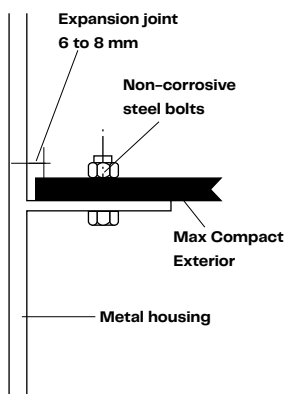

11 09

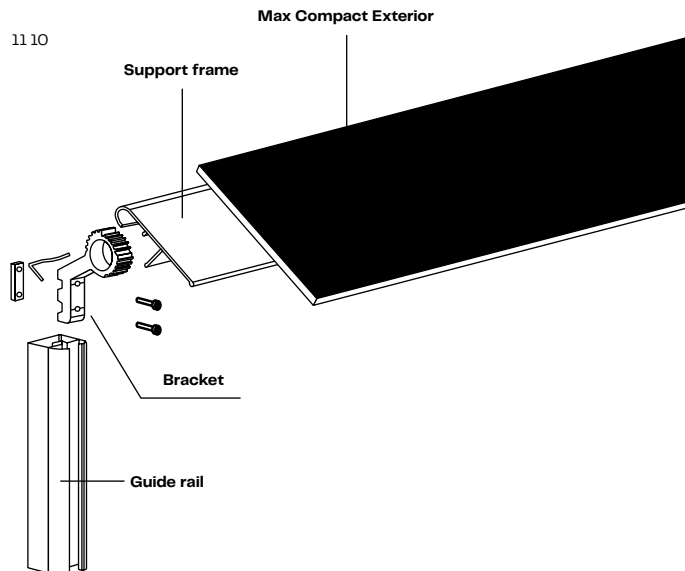
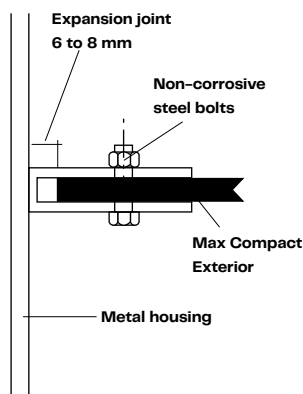

Sliding Panels and Folding Sliding Panels



Combined with high-quality fittings, Max Compact Exterior panels are extremely suitable as decorative facade elements and for providing state-of-the-art sun protection.

General Guidelines

During planning and construction, please be sure not to exceed the maximum permitted weight of the fittings. Precise information on each fitting can be obtained from the respective manufacturer (e.g., Hawa; for contact details, see the “Suppliers and Components” section).

Maximum Fastener Spacing

If possible, installation should be carried out using a frame. Fastening can be carried out using rivets, adhesive, or invisible mechanical fasteners. Detailed recommendations for the relevant type of installation, such as fastener spacing and installation notes, can be found in the previous section, “Facades.”



Sliding



Folding + sliding



Turning + slotting
sliders

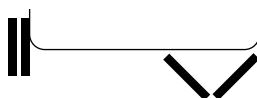

Folding + slotting
sliders



Sliding + stacking

Attaching Hinges

When attaching hinges, fitting them on the surrounding metal frame is recommended. Use at least three hinges per element. Aluminum profile systems and powder-coated steel frame profiles can be used as metal frames. The frame must have sufficient load bearing capacity. Max Compact Exterior panels should be installed with sufficient expansion clearance of at least 4.0 mm on each side. UV- and weather-resistant sealing tape (e.g., EPDM) should be applied between the profiles and the panels (to avoid noise caused by hammering). Attaching the panels using adhesive is not approved. Ensure there are drill holes in the bottom horizontal frame profile for drainage.

For sliding elements, the panels can also be fitted onto a metal frame. Fastening is ensured using rollers that need to be mounted on the frame profiles. Sliding fittings must have sufficient load bearing capacity. Bear in mind the maximum fastener spacing (see table).

Max Compact Exterior panels: Installation using a frame structure—fastener spacing

Panel thickness (in mm)	Length (in mm)	Height (in mm)
6.0	≤ 500.0	≤ 500.0
8.0	≤ 600.0	≤ 600.0
10.0	≤ 600.0	≤ 600.0
12.0	≤ 600.0	≤ 600.0

12 Suppliers and Components

Substructure

Austria

ALLFACE Befestigungstechnologie GmbH & Co KG
Aredstraße 29/Büro 222
2544 Leobersdorf, Austria
Tel: +43 (0)2256 625 18
Fax: +43 (0)2256 625 18-18
www.allface.com

Hilti Austria Ges.m.b.H.
Altmannsdorfer Straße 165
1230 Vienna, Austria
Tel: +43 (0)800 81 81 00
Fax: +43 (0)800 20 19 90
www.hilti.at

Slavonia Baubedarf GmbH
Hauffgasse 3-5
1110 Vienna, Austria
Tel: +43 (0)1 769 69 29
Fax: +43 (0)1 769 69 27
www.slavonia.com

Germany

BWM Dübel und Montagetechnik GmbH
Ernst-Mey-Straße 1
70771 Leinfelden-Echterdingen, Germany
Tel: +49 (0)711 90 313-0
Fax: +49 (0)711 90 313-20
www.bwm.de

Systema GmbH
Margarete-Steiff-Straße 6
24558 Henstedt-Ulzburg, Germany
Tel: +49 (0)4193 9911-0
Fax: +49 (0)4193 9911-29
www.systema-systems.com

NAUTH SL Fassadentechnik GmbH
Weinbergstraße 2
76889 Kapellen-Drusweiler, Germany
Tel: +49 (0)6343 7003-0
Fax: +49 (0)6343 7003-20
www.nauth.de

France

LR ETANCO
38/40 Rue des Cormiers
BP 21
78401 Chatou Cedex, France
Tel: +33 (0)1 3480 5288
Fax: +33 (0)1 3480 5240
www.etanco.fr

Fasteners (Mechanical)

Austria

EJOT AUSTRIA GmbH
Grazer Vorstadt 146
8570 Voitsberg, Austria
Tel: +43 (0)3142 276 00-0
Fax: +43 (0)3142 276 00-30
www.ejot.at

Germany

MBE GmbH
Siemensstraße 1
58706 Menden, Germany
Tel: +49 (0)2373 17430-0
Fax: +49 (0)2373 17430-11
www.mbe-gmbh.de

SFS intec GmbH, Division Construction
In den Schwarzwiesen 2
61440 Oberursel, Germany
Tel: +49 (0)6171 7002-0
Fax: +49 (0)6171 7002-55
www.sfsintec.de

KEIL Werkzeugfabrik Karl Eiseid GmbH
Postfach 1158
Im Auel 42
51766 Engelskirchen-Loope, Germany
Tel: +49 (0)2263 8070
Fax: +49 (0)2263 807333
www.keil-werkzeuge.com

Switzerland

SFS intec AG (Headquarters)
 Rosenbergsaustasse 10
 9435 Heerbrugg, Switzerland
 Tel.: +41 (0)71 727 62 62
 Fax: +41 (0)71 727 53 07
www.sfsintec.biz

Switzerland

SIKA Chemie GmbH
 Tüffenwies 16-22
 8048 Zurich, Switzerland
 Tel.: +41 (0)58 436 40 40
 Fax: +41 (0)58 270 52 39
www.sika.ch

Fasteners (Adhesive)**Austria**

Fassadenklebetechnik Klug GmbH (Zentrale)
 Julius-Tandler-Platz 6/15
 1090 Vienna, Austria
 Tel.: +43 (0)676 7271724
www.fassadenklebetechnik.at

Pro Part Handels GmbH
 Lauchenholz 28
 9123 St. Primus, Austria
 Tel.: +43 (0)4239 40 300
 Fax: +43 (0)4239 40 300-20
www.fassaden-kleben.at

Innotec Industries Vertriebs GmbH
 Lofererstraße 83
 6322 Kirchbichl, Austria
 Tel.: +43 (0)5332 70 800
 Fax: +43 (0)5332 70 8000-809
www.fassadenverklebung.at

Germany

Innotec GmbH & Co. KG
 Kamper Straße 54
 47445 Moers, Germany
 Tel.: +49 (0)2841 78670
www.innotec.info

Other Adhesive Suppliers

(There is no building regulation approval for the adhesive suppliers and adhesives mentioned in Germany. Clarify technical approvals and installation guidelines with the manufacturer prior to installation.)

Austria

DKS Technik GmbH
 Gnadenwald 90A
 6069 Gnadenwald, Austria
 Tel.: +43 (0)5223 48 488-12
 Fax: +43 (0)5223 48 488-50
www.dks.at

Germany

SOUDAL N.V.
 Olof-Palme-Straße 13
 51371 Leverkusen, Germany
 Tel.: +49 (0)214 6904-0
 Fax: +49 (0)214 6904-65
www.soudal.com

Profiles/Components

Austria

Protektor Bauprofile GmbH
Hirschstettnerstraße 19/Bauteil 15/Zimmer 318
1220 Vienna, Austria
Tel: +43 (0)1 259 45 00-0
Fax: +43 (0)1 259 45 00-19
www.protektor.com

Germany

Protektorwerk Florenz Maisch GmbH & Co. KG
Viktoriastraße 58
76571 Gaggenau, Germany
Tel: +49 (0)7225 977-0
Fax: +49 (0)7225 977-111
www.protektor.com

France

PROTEKTOR SAS
ZAE des Portes de la Forêt
43 allée du Clos des Charmes
77090 Collégien, France
Tel: +33 (0)1 60 33 25 20
Fax: +33 (0)1 60 33 06 56

Glass Clamp Holders

Austria

Längle, 6840 Götzis, Austria
www.langleglas.com
Schmidtschläger, 1070 Vienna, Austria
www.schmidtschlaeger.at
Hueck, 1230 Vienna, Austria
www.hueck.at

Germany

Pauli, 51545 Waldbröl, Germany
www.pauli.de
SWS, 51545 Waldbröl, Germany
www.sws-glassysteme.com
QTEC, 06749 Bitterfeld, Germany
www.q-tec-gmbh.de

Sun Protection

France

SAB International
19 ZA Saint Mathieu
28320 Gallardon, France
Tel: +33 (0)2 37 90 46 46
Fax: +33 (0)2 37 90 20 10
www.sab-inter.com

EPDM Membrane Strips

Austria

Euphalt Handels-GesmbH
Gewerbeallee 5
4221 Steyregg, Austria
Tel: +43 (0)732 640 500
www.euphalt.at

Germany

MBE GmbH
Siemensstraße 1
58706 Menden, Germany
Tel: +49 (0)2373 17430-0
Fax: +49 (0)2373 17430-11
www.mbe-gmbh.de

SFS intec GmbH, Division Construction
In den Schwarzwiesen 2
61440 Oberursel, Germany
Tel: +49 (0)6171 7002-0
Fax: +49 (0)6171 7002-55
www.sfsintec.de

BOSIG Baukunststoffe GmbH
Roland-Schmidt-Straße 1
04910 Elsterwerda, Germany
Tel: +49 (0)3533 700-0
Fax: +49 (0)3533 700-200
www.bosig.de

Touch-Up Markers (Varnish)

Austria

VOTTELER Lacktechnik GmbH
Malvenstraße 7
4600 Wels, Austria
Tel.: +43 (0)7242 759-0
Fax: +43 (0)7242 759-113
www.votteler.com

Germany

Heinrich König & Co. KG
An der Rosenhelle 5
61138 Niederdorfelden, Germany
Tel.: +49 (0)6101 53 60-0
Fax: +49 (0)6101 53 60-11
www.heinrich-koenig.de

MBE GmbH

Siemensstraße 1
58706 Menden, Germany
Tel.: +49 (0)2373 17430-0
Fax: +49 (0)2373 17430-11
www.mbe-gmbh.de

Fittings

Europe

Hawa Sliding Solutions AG
info@hawa.com, Tel: +41 (0) 44 787 17 17
Werk Mettmenstetten (Headquarters)
Untere Fischbachstrasse 4
8932 Mettmenstetten, Switzerland

North America

Hawa Group Americas Inc.
150 Turtle Creek Blvd, Ste 209A Dallas
TX 75207, United States of America
Tel: +1 (0) 214 760 9054

Asia-Pacific

Hawa Sliding Solutions APAC Pte. Ltd
123 Penang Road, #06-13 Regency House
238465 Singapore, Singapore
Tel: +65 (0) 6887 4900

Disclaimer

The information made available in this document is for general information purposes only. Not all of the systems mentioned and shown in this document are suitable or appropriate for all areas of application. All customers and third parties are obligated to inform themselves thoroughly about Fundermax products, including their suitability for certain purposes. Furthermore, we explicitly recommend that you and other users of this document seek out independent expert advice on compliance with local planning and use requirements, applicable laws, regulations, standards, guidelines, and testing standards.

Copyright

All texts, photos, diagrams, and audio and video files are subject to copyright and other laws protecting intellectual property and may not be duplicated, altered, or used on other websites for business purposes, etc.

Fundermax Deutschland GmbH

Mundenheimer Weg 2
67117 Limburgerhof, Germany
infogermany@fundermax.biz
www.fundermax.com

Fundermax France S.a.r.l.

3 Cours Albert Thomas
69003 Lyon, France
T +33 (0)4 78 68 28 31
infofrance@fundermax.biz
www.fundermax.com

Fundermax India Pvt. Ltd.

Sy. No. 7, Honnenahalli, Doddballapur Road,
IND-Yelahanka Hobli, Bangalore - 560064,
India
T +96113 99211
officeindia@fundermax.biz
www.fundermax.in

Fundermax Italia s.r.l.

Viale Venezia 22
33052 Cervignano del Friuli, Italy
infoitaly@fundermax.biz
www.fundermax.com

Fundermax North America, Inc.

9401-P Southern Pine Blvd.
Charlotte, NC 28273, U.S.
T +1 980 299 0035
office.america@fundermax.biz
www.fundermax.us

Fundermax Polska Sp. z o.o.

ul. Rybitwy 12
30-722 Kraków, Poland
T +48 (0)12 65 34 528
infopoland@fundermax.biz

Fundermax Swiss AG

Industriestrasse 38
5314 Kleindöttingen, Switzerland
T +41 (0)56 268 83 11
infoswiss@fundermax.biz
www.fundermax.com

Fundermax GmbH

Klagenfurter Straße 87-89, 9300 St. Veit/Glan, Austria
T: +43 (0)5 9494-0, F: +43 (0)5 9494-4200
office@fundermax.at
www.fundermax.com

