

**“Contemporary technology,
timeless design – that’s what
we want to be surrounded by.”**

(Stephan R., carpenter)

MI AMKOVSKY PEASENA AMPHON ILIJA ANDIC LUCAS ARTNER FACUNDO ASPITIA GEORG BÄCK EMRAH BAKI IAN BARGER
XA ÖZCAN BAYRAKTAR PETAR BEGCEVIC BERNHARD BEIGLBOCK BIRGIT BERGER MIRAN BERLOT MARCIN BIERNAT MILOS
ELJKO BOSNIC DANIEL BRUNNER MARKUS BUBEL SEBASTIAN BUDZYNSKI CH
RYK CZECH DANIJEL DAMNJANOVIC LUKA DAN EMIL DAVID VIRGIL DAVID SIMEON DIMITROY ZIVOJIN DJOKIC
O DOMIC GREGOR DONNER MARKO DRAMAC DRAGAN DRAMAC MIROSLAV DR
RMUS RAINER DUSCHANEK LAURENZ ARTHUR EBNER GISELA EDER OLIVER EICHHORN BERNHARD ENDLER MARKU
ANDRA FRANK WILLIAM FURY LEOPOLD GABLEK RAFAL GABRYSIK DARIUSZ GARTNER MATHIAS GEHRINGER WIESLAW
IPP GRANDITS MICHAEL GROLL JANIK GRZEGORZ DAVID GUMPOLD DANIEL GURAN MEHMET GÜVEN HERMANN HACKL
K LUKAS HARRER ROBIN HARTL JOHANNES HARTWEGER ALEXANDRA HEIDERER JÜRGEN HEILIGENBRUNNER NATALIE
AN HÖHER HARALD HÖLLER MARIO HÖLLHÜBER MANUEL HOLZER MATTHIAS
IC KRESIMIR JANJIC DANIEL JANKER ALEXANDER JAVANOVIC ANDREAS JETSCHKO DAMIAN JEZAK DALIBOR JOVICIC
ROLAND KAISER MARKUS KARL ROMAN KARNER YASIN KAYA SAKIR KAYA ZSOLT KISS MATEUSZ MARCIN KLUK TIBOR
AN KOROTAJ KRZYSZTOF KORSZUN HUBERT KOSIOR CHRISTOPHER KOTMILLER LEONID KRASNIQI MANFRED KREISEL
UBANIK ERWIN KUBICEK MARIUSZ KUCZYŃSKI NAVEEN KUMAR SEBASTIAN KUNZ JOHANN KUPKA KAMIL KWASIZUR EDIN
EXANDER LEUTGEB PETER LIGAI ISTVAN LIGAI CARLA LO CHRISTIAN LÖBSCH KURT LOM RAINER LOOS CHRISTOPH
CHAEEL MARHOLD OLGICA MARIC SLAVKO MARIC ZLATKO MARKOVIC HELMUT MÄRTIN JAQUELINE MAURER MICHAEL
S MEINHOLD LATIF MEMIC RENE MERL THOMAS MEYER MILAN MIJALKOVIC MARKUS MILANOVITS MIKOLAJ MIODEK
E BERND MRLIK ALEXANDER MUHR LEOPOLD MÜLLER NE
MURATSPAHIC ROBERT NAVRKAL RENATE NEDELJKOVIC
SMÜLLER RAINER OBED MOSPURGER OLIVER GERALD O
AYHAN ONMAZ PETER ORBAN ATTILA ORBAN PIOTR
ORFER FRANK PETER ACSINTE IONUT PETRU SABINE P
AGODIN PILE TOMASZ PIOTROWSKI JOSEF PIRNGRUBER
LZHOFFER WOJCIECH POSTEK ARCADI POSTOLACHII AN
TZ ROBERT PRANGER RAINER PRENNER MARIO PREYER
DOVAN RADOMAN IVAN RADOVANOVIC DRAGAN RADI
CH RAMSTÖTTER JOSEF RATHMAIR LUKAS RATHMAIR
ANZ RIEPL MANFRED RÖSSLER VALENTIN RUSEANU P
MASZ RYBA SENAD SARKINOVIC SIEGRID SCHARRER
AEL SCHMID-MORAWITZ ALLE DIESE PERSONEN WAF
IG UND DEM BAU DER SCHULE BETEILIGT GERFRIED
ALD SEIDL VASIL SHESMINAH ELEZI SHPENDIT BE
LNI MIHAJLO SKOLNIK MILAN SLIJEPCEVIC EWAI
OT ALBERT SPAHIU KARL STABENTEINER ANTON
ERNHARD STEFAN MARCO STEINER STEFAN STEIN
NER SARA STOJAKOVIC MIROSLAV STOJANOVIC
SJJIN TAHIRI GYULA TANAI DOMINIK TATZREITER
IKVICKI PATRICK TILLICH DRAGAN TODOROVIC
DARKO TOMIC JANOS TOTH STEFAN TRAXLER M
MA LUCIA TURANSKA HACI TÛTÛNCÛ ANDREAS
AVROVIC PETER VOGL IRENE VORMAIER ARNO W
IDREAS WEIGEL THOMAS WEISS FRANZ WIESER
NIOWSKI SASCHA WIATER MICHAEL WITZMANN F
FINGER DAMIAN WONTOROZYK ÖZGUR YILDIZ



Contents

Products	4
Sustainability and the Environment	10
Material	14
Processing recommendations	18
Chemical resistance	36
Cleaning	44
Wall cladding	46
Non-ventilated wall cladding	54
Cubicles	80
Soffits and ceilings	90
Table tops	96
Furniture	100
Worktops	106
Wash basins	116
Railings	120

Note:

Current version of this brochure:
www.fundermax.com

The following diagrams in this brochure are schematic representations and not true to scale.

This issue replaces all previously published issues of the Technique Interior Brochure by Fundermax.

If you have any questions that this brochure does not answer, please contact our sales team or application engineers at support@fundermax.biz. We will be happy to help you.

Fundermax

No matter whether it's furniture, facades, or interior design: where ideas and materials meet, you'll find Fundermax. As a global market leader in the field of compact panels and a manufacturer of high-quality wood-based materials and laminates, the company is proud to look back on a history spanning 130 years. The continued success is based on the highest quality, innovative and varied design, and sustainable production. Made in Austria—with great love for wood as a natural material, creations, and imagination.

- modern production facilities in Austria and Norway
- around 1,500 employees
- annual sales of €500 million
- part of Constantia Industries AG
- The Austrian Excellence Award (2018)

1 Products

“Only good ideas and good products are really durable.”

(Isabelle S., Project Manager)





Max Compact Interior

These are thermoset high-pressure laminates (HPL) that meet the requirements of EN 438 and are produced at high temperature and under great pressure. The product variants are as diverse as the applications: The panels are suitable not only for use in sanitary and wet rooms, but also as wall and column cladding, as railing fillings, as furniture, tables, desks and laboratory furniture. Whenever both resilience and aesthetics are required.

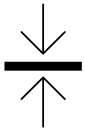

resistant



impact-resistant



scratch resistant



quick installation



solvent resistant



food grade



easy to clean



heat resistant

Properties*

- hygienic
- bending resistant and impact resistant (according to EN ISO 178)
- suitable for all indoor applications
- decorative
- resistant to scoring
- abrasion resistant
- frost and heat resistant
- continuous temperature load -80 °C to $+80\text{ °C}$
- easy to install
- resistant to chemicals

* Standard and actual values: www.fundermax.com

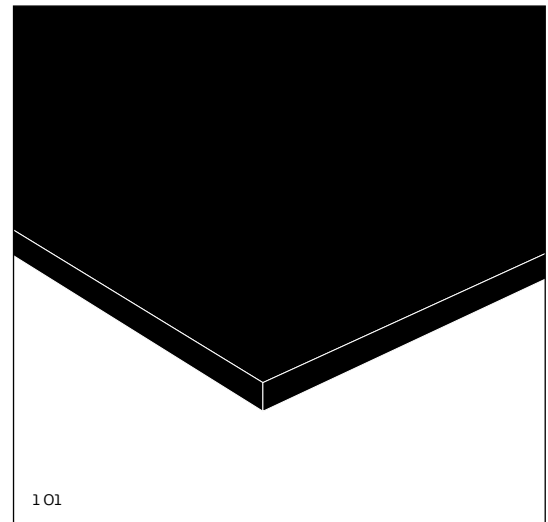

Formats*

The overview shows Max Compact Interior panel formats in various product designs.

Tolerances: +10,0–0,0 mm (EN 438–4, 6.3)

Panel formats are standard sizes—if absolute size and angle precision is required, it is recommended to cut around all sides. Depending on the cut, the net measurement reduces by about 10 mm.

Thickness	Tolerance (EN 438–4, 6.3)
• 2.0–2.9 mm	±0.2 mm
• 3.0–4.9 mm	±0.3 mm
• 5.0–7.9 mm	±0.4 mm
• 8.0–11.9 mm	±0.5 mm
• 12.0–15.9 mm	±0.6 mm
• 16.0–19.9 mm	±0.7 mm
• 20–25 mm	±0.8 mm

* Subject to change due to product development. Please refer to the valid product portfolio.

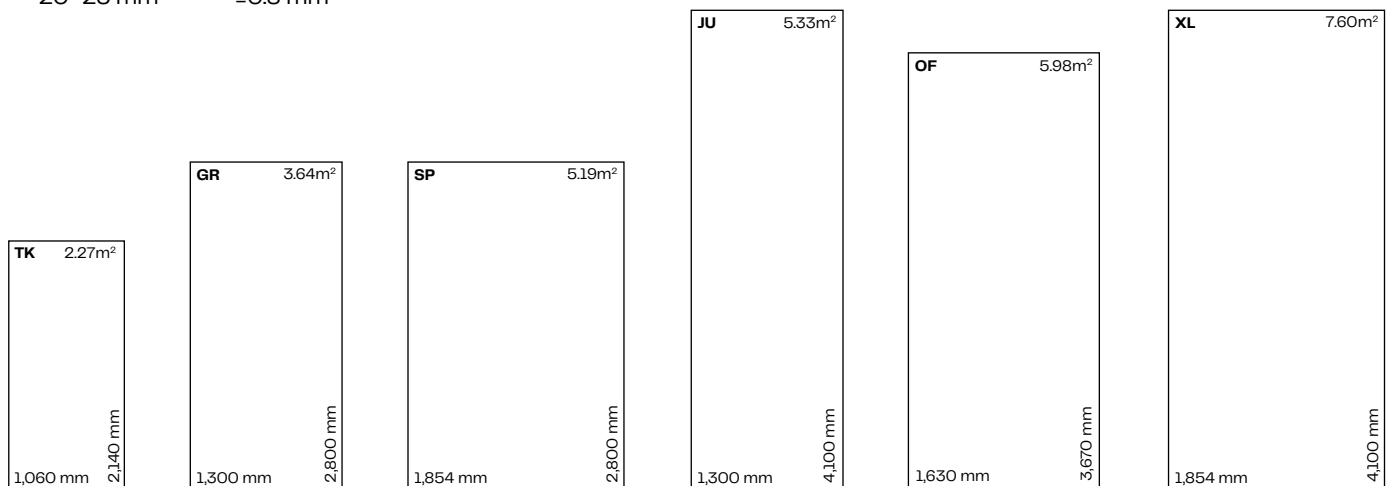

For the current product portfolio with format sizes for each product see: www.fundermax.com

Product selection

Max Compact Interior

Max Compact panels come with decorative laminate on both sides as standard. The core is black and the surfaces are available in various structures (see current product portfolio).

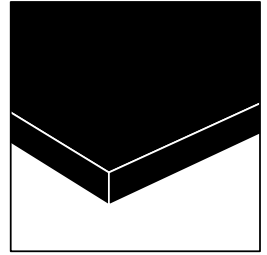

Max Compact Interior Plus

These panels have the same qualities as the Max Compact Interior panels, but are manufactured with a double-hardened, non-porous surface sealed with urethane acrylate for increased surface protection (decors: see decor collection IP).

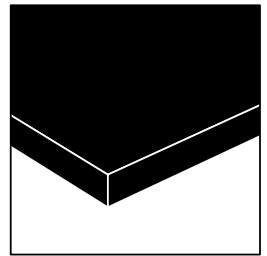

Max Resistance²

Max Compact Interior panels with integrated, chemical-resistant surface (decors: see decor collections Resistance² RE).

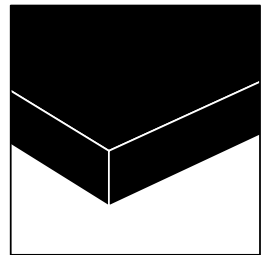

Max Compact with white/ solid colored core

Panel core white or solid color. There can be a slight color difference between the laminate and the Compact panel with black core. If these are to be combined please compare samples! We recommend sealing the edge with clear lacquer for a permanently attractive appearance in areas subject to heavy wear. Same decors on both sides. Decors and surfaces according to the valid product portfolio.

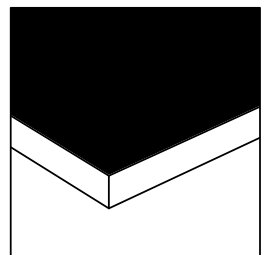

Alu Compact

Max Compact Interior panels with aluminum strips symmetrically inserted in the core. This makes the panels a modern design element.

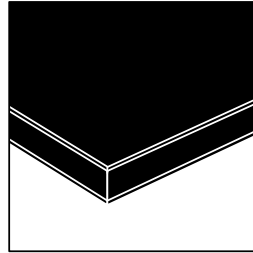

Fundermax elements (processing)

CNC controlled processing and panel cutting – from drilling simple holes to intricate milling.

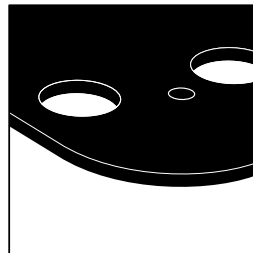

m.look wall protection system

An innovative wall protection system and wall cladding for visual highlights and contemporary architecture, consisting of large-area panels with a heavy-duty core and decorative HPL surfaces on both sides (according to EN 438).

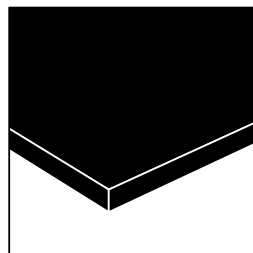

2 Sustainability and the Environment

“I want my work to leave a mark – but it should be sustainable.”

(Henrik T., entrepreneur)

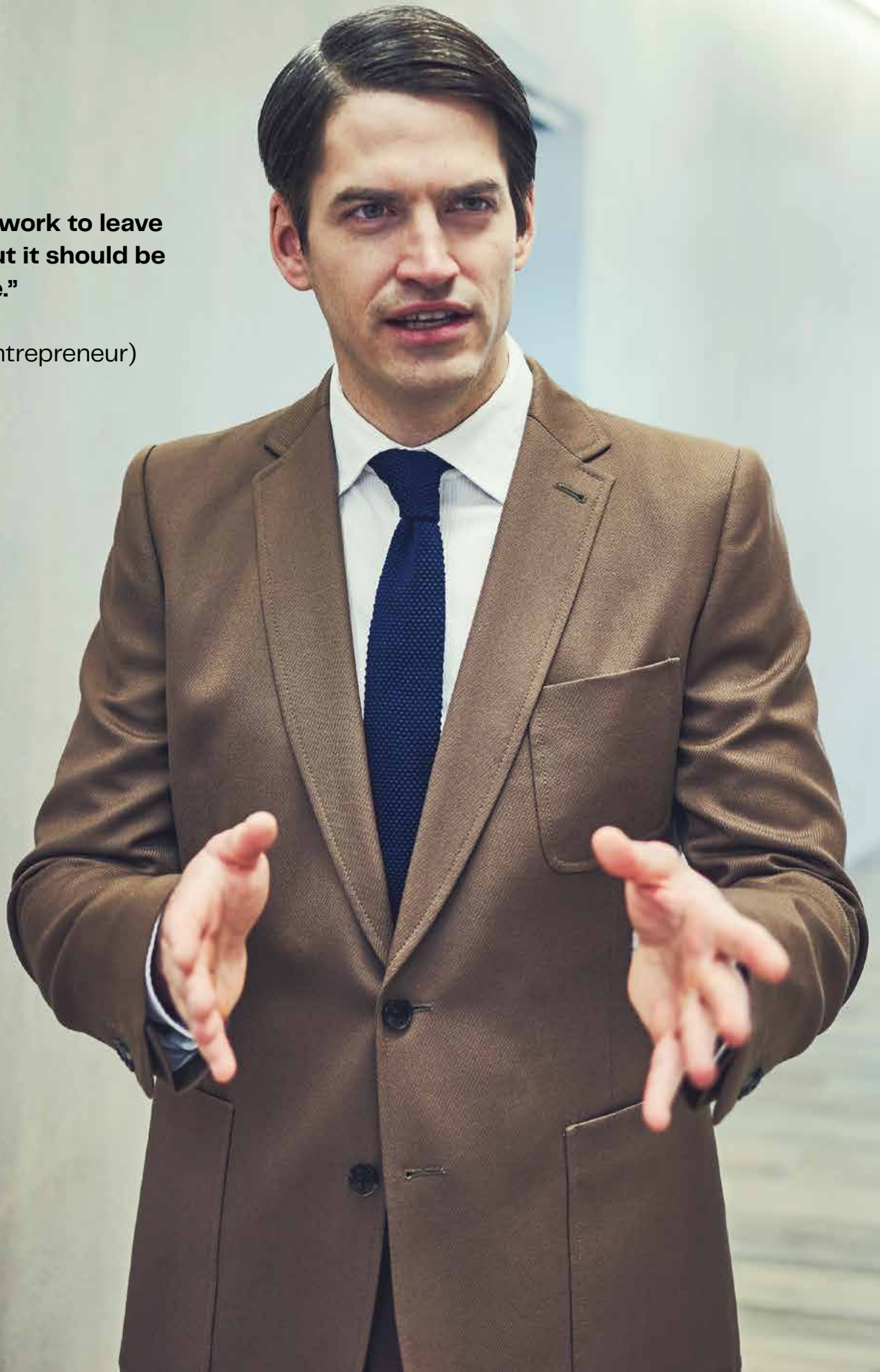



Fundermax has been a specialist in the processing of renewable raw materials for over 100 years. We have closed production cycles and recycle residues by returning them to the manufacturing process or to green power district heating plants. The latter produce enough electricity to supply over 8,500 households.





Quality management

The production facilities and processes are according to internationally recognized standards (ISO 9001, ISO 14001, ISO 50001, ISO 45001). Fundermax also follows current standards such as FSC®-C101966 and PEFC™ (details: www.fundermax.com) in the procurement of raw materials and primary products.

Sustainable production

Max Compact Interior panels are made of natural fiber panels (about 65% of the total weight) and are made mainly of wood which is refined into "kraft papers." This wood is a by-product from lumber production and in sawmills. The raw materials come from suppliers certified to the FSC®-C101966 and PEFC™ standards, which guarantee sustainable forest management.

Kraft papers are impregnated with synthetic resins in impregnation plants, then dried and pressed into panels under high pressure and temperature. They do not contain any organic halogen compounds, asbestos, wood preservatives (fungicides, pesticides, etc.), sulfur, mercury or cadmium.

The exhaust air extracted during drying is treated with regenerative thermal oxidation. The heat generated from this is recycled back into the process, saving around 10,000 t of CO₂ annually. This exhaust air treatment also received the "klimaaktiv" award from the Austria Energy Agency and the Federal Ministry for the Environment.

Maintenance-free durability

The manufacturing process ensures that Max Compact Interior panels have a high level of durability and surface resistance – without needing any maintenance. They do not soil easily, but if they do get dirty they can be cleaned with standard cleaning agents. It is not necessary to seal the edges (even after cutting). The panels do not show any dents even after heavy use, such as when used as impact protection.

Waste disposal

When Max Compact Interior panels are cut and milled they produce chips. These can be disposed of thermally, in modern heating systems, without the emitting hydrochloric acid, organic chlorine compounds or dioxins. Max Compact Interior decomposes into nothing but carbon dioxide, nitrogen, water and ash. The resulting energy is used for district heating, for example. Disposal at commercial landfills is also unproblematic – country-specific laws and regulations apply.

3 Material



A man with short, light brown hair and blue eyes is shown from the chest up. He is wearing a dark blue jacket with a subtle red and white plaid pattern over a dark blue button-down shirt. His hands are clasped together in front of him, and he is looking slightly to the right of the frame with a thoughtful expression. The background is a blurred, modern architectural interior with white and grey geometric shapes and bright lighting.

“The material is instrumental in determining whether an idea remains just an idea.”

(Hannes K., architect)

Material properties

	Max Compact Interior Max Compact Interior Plus Max Resistance²	Max Compact Interior F-Quality Max Compact Interior Plus F-Quality	Max Compact with white / colored core	Max Compact Interior Alu Compact
Type according to EN 438	CGS	CGF	BCS	RCS

Properties	Test method	Standard value ¹⁾	Typical value ²⁾	Unit of measurement
------------	-------------	------------------------------	-----------------------------	---------------------

Physical data

Bulk density	DIN 52350 ISO 1183	≥ 1.35 (CGS/CGF/RCS) ≥ 1.40 (BCS)	≥ 1.44 (CGS/CGF) 1.46 (BCS) 1.52 (RCS)	g/cm ³
Weight (thickness 10 mm)			13.5	kg/m ²

Mechanical properties

Resistance against stress abrasion (initial point)	EN 438-2: 2016, 10	≥ 150 (BCS/CGS/CGF/RCS)	200 Resistance ² / Surface Aptico Uni: ≥ 450 Resistance ² Punto: ≥ 150	U
Resistance to impact with a large ball	EN 438-2: 2016, 21	≤ 10 (CGS/CGF/RCS)	5-6 (CGS/CGF/RCS)	mm
Scratch-resistance	EN 438-2: 2016, 25	≥ 3 (BCS/CGS/CGF/RCS)	4 (BCS/CGS/CGF/RCS)	Degree/ scratch hardness
Flexural strength	EN ISO 178	≥ 80 (BCS/CGS/CGF/RCS)	crosswise: 110 / length: 180	MPa
E-Modulus	EN ISO 178	≥ 9000 (BCS/CGS/CGF/RCS)	crosswise: 11000 / length: 15000	MPa
Susceptibility to cracking	EN 438-2: 2016, 24	≥ 4 (CGS/CGF/RCS) ≥ 4 (BCS surface) ≥ 3 (BCS core)	4 (CGS/CGF/RCS) 5 (BCS surface) 3 (BCS core)	Degree

Thermal properties

Dimensional tolerance at high temperature	EN 438-2: 2016, 17	Type CGS/CGF/RCS: ≤ 0.30 lengthwise / = 0.60 crosswise Type BCS: ≤ 0,50 lengthwise / = 0,80 crosswise	Type CGS/RCS: 0.10 lengthwise / 0.21 crosswise Type CGF: 0.08 lengthwise / 0.16 crosswise Type BCS: 0.20 lengthwise / 0.33 crosswise	%
Resistance to dipping in boiling water	EN 438-2: 2016, 12	Thickness increase ≤ 2.0 (CGS/RCS) / ≤ 6.0 (CGF) ≤ 4.0 (BCS)	0.5 (CGS/CGF/RCS) 1.5 (BCS)	%
Coefficient of thermal expansion	EN 61340-4-1		20 x 10 ⁻⁶	1/K
Thermal conductivity			approx. 0.3	W/mK
Resistance to vapor diffusion			17200 μ (CGS/CGF) vapor diffusion density (RCS)	
Surface resistance	DIN 53482		10 ⁹ -10 ¹²	Ohm
Resistance to dry heat	EN 438-2: 2016, 16	≥ 4 (BCS/CGS/CGF/RCS)	4 (BCS/CGS/CGF/RCS)	Degree
Resistance to humid heat	EN 438-2: 2016, 18	≥ 4 (CGS/CGF/RCS)	4-5 (CGS/CGF/RCS)	Degree
Resistance to water vapor	EN 438-2: 2016, 14	≥ 4 (BCS/CGS/CGF/RCS)	5 (BCS/CGS/CGF/RCS)	Degree

Optical properties

Light fastness	EN 438-2: 2016, 27	4-5 (CGS/CGF) ≥ 4 (BCS surface)	4-5	Gray scale
Stain resistance	EN 438-2: 2016, 26	≥ 4 (Group 1 and 2) 5 (Group 3)	5	Degree
Gloss level at 85°	EN ISO 2813	depending on the surface structure	Aptico surface: 7 Other surfaces: depending on the surface structure	GE

Fire behavior

Building material class	Max Compact Interior Type CGS	Max Compact Interior F-Quality Type CGF
Europe EN 13501-1 EUROCLASS	D-s2, d0	B-s2, d0 / B-s1, d0 ³⁾
Austria A3800/1	low flammability Tr1, Q1	low flammability Tr1, Q1
Switzerland fire classification		5(200°)3
Germany DIN 4102		B1 – flame retardant

1) according to EN 438

2) Typical values result from internal quality checks. They are presented exclusively as examples and cannot be used for any liability on the part of Fundermax (they are not confirmed, guaranteed values).

3) for 6-20 mm when installed with max. 15 mm rear ventilation according to classification report MA39-VFA2019-1215

Material characteristics

Material quality

3 01 Dimensional change with moisture release or absorption

Material characteristics and expansion clearance

Max Compact panels react to temperature and humidity, according to the climactic conditions of the respective storage and mounting area. If both of these influential factors affect one side of the panel only for a longer period of time, it can lead to variations of flatness to a greater or lesser extent. Please take note of our advice concerning rear ventilation, storage and stack coverage!

Max Compact shrinks when moisture is released and expands when moisture is absorbed. Therefore, thought must be given to this possible dimensional change when working and constructing. For Max Compact it is basically about half as much lengthwise (relative to the nominal panel formats) as in the width (see Material properties, page 16).

Metal substructures change their dimension with temperature differences. However, Max Compact dimensions also change under the influence of increasing relative humidity. These dimensional changes of the substructure and cladding material can work in opposing directions. Therefore, it is important to ensure sufficient room for expansion.

Max Compact Panels can also be used in horizontal applications. In daily use, highly textured or deep matte surfaces may show visual glossing due to mechanical stress (e.g. due to shifting objects around such as plates or glasses). This effect is stronger in combination with dark decors and is a material-typical aging. It does not represent a deviation from the standard.

Rule of thumb for the amount of expansion clearance needed:

Element length = a
Element width = b

$$\frac{a \text{ or } b \text{ (in mm)}}{500} = \text{expansion clearance}$$

For Max Compact panel type CGS and CGF, OFI CERT as a global authorization body confirms the compliance with the quality standards in accordance with EN 438.

Hygiene

The surfaces of Fundermax panels are distinguished by their easy cleaning, maintenance, disinfectability and harmlessness in contact with food.

Please take the validity of the respective test certificates into account. You can find the current certificates at www.fundermax.com in the "Download" section, under "Approvals and test certificates."

Please also take note of the valid standards, regulations and guidelines for possible applications of materials with regard to fire behavior and fall protection.

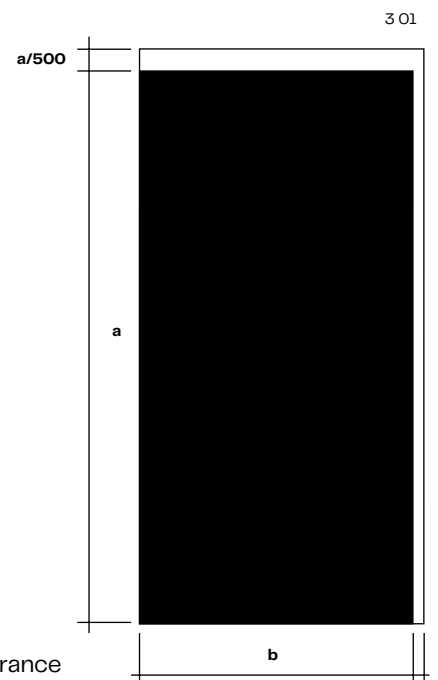

4 Processing recommendations





**“Good products call for
good treatment.”**

(Jonas G., contractor)

Guidelines for handling Max Compact Interior

- 4 01 Max Compact Interior handling
- 4 02 Max Compact Interior stack storage
- 4 03 Short term temporary storage
- 4 04 Storage of pre-assembled elements

Transport and manipulation

Handle with care! Despite surface hardness and transport protection film, the stack weight can cause damage. Therefore, it is important to avoid getting dirt or dust between the panels.

Secure the panels against slipping during transport and lift them during loading and unloading – do not pull or push them over the edge (see Fig. 4 01)!

Always remove transport protection films from both sides at the same time. Leaving the protection film on one side may cause curvature of the panel. To prevent surface damage: Do not remove the film until it is necessary. Increased adhesion of the film after storage may occur, requiring more force to remove it. This does not affect the quality of the product and is not a reason for complaint. Do not expose the film to direct sunlight or heat!

Storage and air conditioning

Max Compact Interior panels must be left in their original packaging. They should be stacked horizontally on a flat, stable and padded surface. If necessary, they can be stored for a short time as shown in Fig. 4 03. The panels must lie completely flat. After removal, the original packaging should be closed again.

Cover plates must always be left on the stack (see Fig. 4 02). The top cover should be weighted down. This also applies to cut-panel stacks.

Incorrect storage will cause permanent deformation of the panels. Max Compact Interior panels should be stored indoors, under normal climatic conditions (15°C to 25°C, with relative humidity at 40-60%). Avoid climatic differences on the two surfaces.

In the case of preassembled fastening elements, make sure the climatic influence is the same from all sides. Use intermediate layers of wood or plastic (see Fig. 4 04).

Final cleaning

Foreign substances (e.g., drilling and machine oils, greases, adhesive residues, etc.) that soil the surface of the Max Compact Interior panels during storage, installation and use must be removed immediately without leaving any residue. We recommend using grease-free sunscreen (e.g., Physioderm Physio UV 50 Spray), since it is often not possible to remove conventional sunscreens completely. If these recommendations are not observed, we cannot accept responsibility for any complaints regarding color, gloss or surface. See Chapter 6, page 45 for cleaning details.

4 01

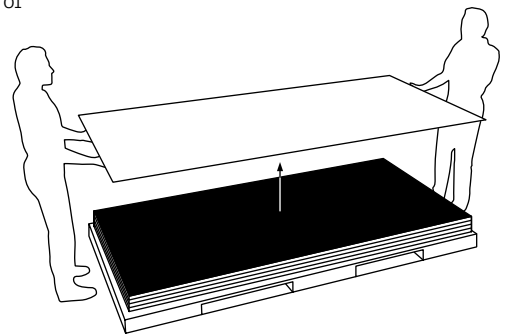

4 02

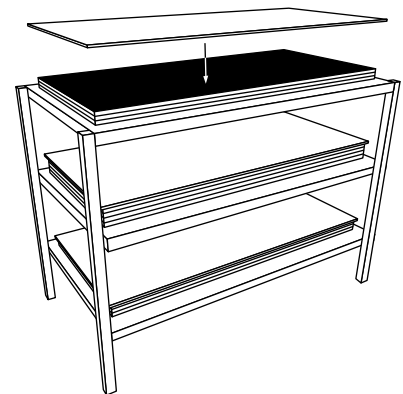

4 03

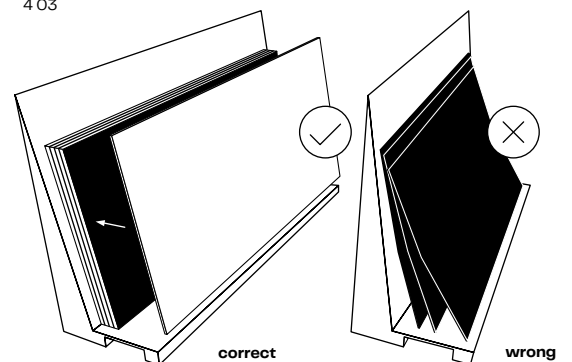

4 04

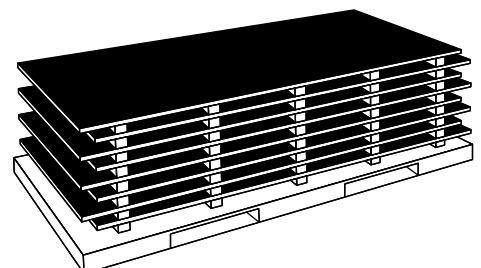

Working with Max Compact Interior

General

High-quality melamine resins make the panel surface very resistant. The processing properties are similar to those for the processing of hardwood. Tools with hard metal cutting edges are essential. Use tools equipped with diamond tips (PCD) for a long service life. To prevent chipping, splintering and flaking of the decorative side, sharp blades and smooth functioning of the tools are a must. To protect the surface and prevent chips from becoming lodged, machine tables should be smooth and as jointless as possible. This also applies to tables and using hand-held machines.

Safety measures

This is a list of the recommended personal protective equipment (PPE). The protective equipment required for the respective activity must be used (work clothes, safety boots, hairnets, etc.).



Gloves:

Non-beveled cutting edges are sharp. You should use gloves of protection category II with at least cut resistance 2.



Dust protection:

Processing these panels can create dust. Adequate respiratory protection (e.g., disposable fine dust mask) must be used.



Safety glasses:

When working with Max Compact Interior panels, as with other wood-based materials, use eye protection that is as tightly sealed as possible.



Hearing protection:

The sound level can rise above 80 dB(A) during mechanical processing. Please always make sure you have adequate hearing protection!

EN 388		Mechanical risks	
		The higher the number, the better the test result.	
Test criterion	Possible ratings		
Abrasion resistance	0-4	4	1 2 1
Cut resistance	0-5		
Tear strength	0-4		
Puncture resistance	0-4		

General processing guidelines

Keep in mind the ratio between the number of teeth (z), cutting speed (v_c) and the feed rate (v_f).

	v_c m/s	fz mm
Sawing	40.0-60.0	0.02-0.1
Milling	30.0-50.0	0.3-0.5
Drilling	0.5-2.0	0.1-0.6

Calculating the cutting speed

$$v_c = D \cdot \pi \cdot n / 60$$

v_c – cutting speed

D – tool diameter [m]

n – tool speed [min⁻¹]

Calculating the feed rate

$$v_f = f_z \cdot n \cdot z / 1000$$

v_f – feed rate [m/min]

f_z – tooth feed

n – tool speed [min⁻¹]

z – number of teeth

Cutting material

Use tools with hard metal cutting edges (HW-Leitz). In order to extend the life of your tools we recommend using diamond-tipped tools (DP polycrystalline diamonds).

Notes

If the chips are not regularly removed, this can quickly lead to damage of the blade. The required motor power is increased and the tool life is shortened. If the shavings are too small, they will scrape and eventually blunt the tool. For single cuts, prevent vibrations by working with used panels. Stack height depends on machine power.

Tooth forms

TR/TR (trapezoid tooth/trapezoid tooth):

For cutting hard, abrasive laminates

HZ/DZ (concave tooth/pointed tooth):

For very good cutting and edge quality at the top and at the bottom on machines without scoring unit

FZ/TR (flat tooth/trapezoid tooth):

For working with laminates and Max Compact Interior

WZ/FA (variable tooth with bevel):

Alternative to flat tooth/trapezoid tooth form

HZ/FA (concave tooth with bevel):

Use similar to HZ/DZ, but with longer tool life on machines without a scoring unit

4 05	TR/TR
4 06	HZ/DZ
4 07	Flat tooth/ trapezoid tooth
4 08	WZ/FA
4 09	HZ/FA

4 05

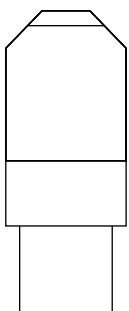

4 06

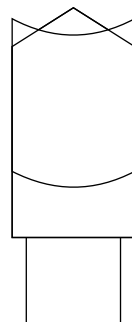

4 07

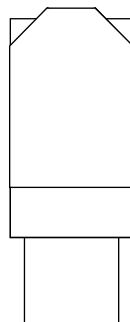

4 08



4 09

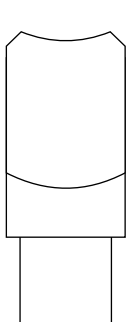

Cutting

4 10

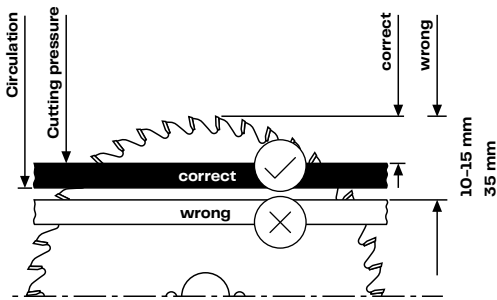

Vertical panel splitting, table and sliding table saws without scoring unit

For circular saw blades with positive rake angle and saw shaft under the workpiece. Due to the positive rake angle, the cutting pressure takes effect using the stable table support (see Fig. 4 10).

4 11

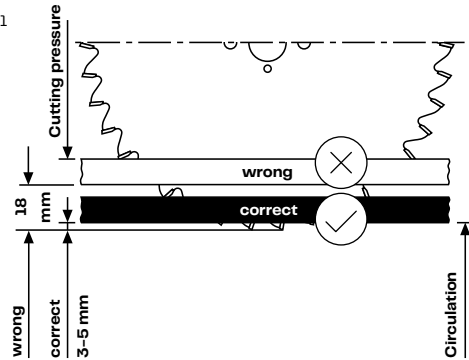

For circular saw blades with negative rake angle and saw shaft above the workpiece. Due to the negative rake angle, the cutting pressure takes effect using the stable table support (see Fig. 4 11).

Adjustment:

- visible side up;
- very narrow saw guide;
- smooth alignment of the Max Compact Interior panels on the workbench with the saw blade;
- correct blade protrusion.

Depending on the blade protrusion, the entry and exit angles will change and thus the quality of the cutting edge. Upper cutting edge unclear: raise the saw blade. Unclean cut on the bottom: lower the saw blade. This is how you find the most favorable height setting.

4 12

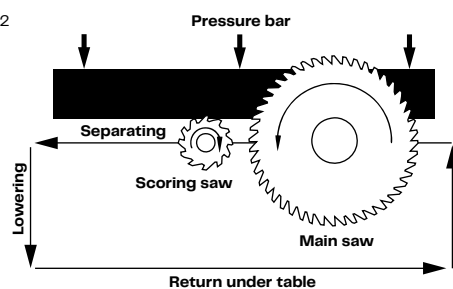

Sliding table saws and panel splitting machines with scoring units and pressure bars

Scoring circular saw blades:

For good cutting edge quality on the tooth exit side, a scoring unit is recommended. Set the cutting width of the scoring circular saw blade to be slightly larger than that of the main circular saw blade so that the exiting tooth of the main saw no longer touches the cutting edge. A safe, flat support of the workpieces is only guaranteed with pressure device. Use split scoring circular saw blades for table and sliding table saws.

4 13 SB main saw blade = nominal SB of the scoring unit

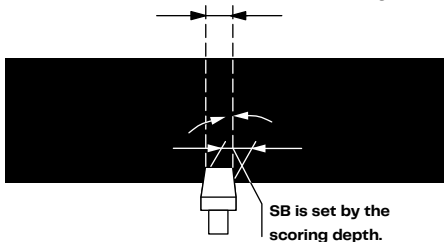

Panel splitting machine with scoring unit and pressure device (see Fig. 4 12)

Operating diagram of the conical scoring circular saw blade (see Fig. 4 13). For the maintenance of the tools (always in sets), the cutting widths (SB) must be aligned with one another.

Milling – Edge processing

Cutting with handheld tools

For straight cuts with handheld circular saws, use a stop bar or guide rail. Saw blades suitable for hard metal should be used. The sawing takes place from the underside of the panel, with a variable tooth for coarse cuts and flat tooth/trapezoid tooth for clean cuts of Max Interior panels and panels which are bonded on both sides.

Edge processing by hand

Files are suitable for edge processing. The filing direction goes from the decor side to the core. Fine files, plane files, sandpaper (100–150 grain) or scrapers are suitable for smoothing edges.

Edge processing with handheld machines

To mill bevels, use electric hand planes with a bevel or miter groove.

Hand routers are used for special tasks (e.g., recess for wash basin, trax coupling, etc.) with hard metal tools. To protect the Max Compact Interior surface, cover the supporting surface of the hand router with e.g., parts of a different panel, don't use felt! Carefully remove milling shavings.

We recommend using hard metal tipped milling cutters with indexable inserts. For better tool utilization, height-adjustable milling tools are preferable. Sharp edges are broken down afterwards.

Edge processing with stationary machines

When milling, pay attention to the optimal ratio of the number of teeth, cutting speed and feed rate. If the shavings are too small, the tool will scrape (burn), become dull and have a short service life. If they are too large, the edges will be wavy (strokes) and unclean.

High rotational speeds ensure good edge quality.

When working with hand fed machines, only use tools marked with "MAN" or "BG-TEST." Do not exceed or fall below the speed range indicated on the tool. Hand fed machines should only be used when working in the opposite direction.

Finishing milled edges: sand the edge surface and smooth out the sharp edges with sandpaper. Hand planes with steel residue can be used for finishing the edges. Use of an HSS blade is recommended (cutting angle: 15°).

For processing Max Compact Interior panels, use milling heads with HW indexable insert blades or diamond-tipped cutters.

- 4 10 Circular saw blades with positive rake angle and saw shaft under the workpiece
- 4 11 Circular saw blades with negative rake angle and saw shaft above the workpiece
- 4 12 Sliding table saw with scoring unit
- 4 13 Operating diagram

Joining

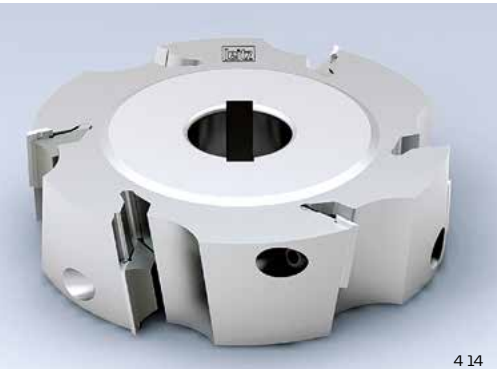

4 14



4 15

To join in climb and conventional milling (e.g., variable milling)

Machines used:

- Table milling machines
- Edge processing machines
- Double-end profiler (hand fed in conventional motion only)

Information on milling equipment:

- Milling head with reversible blades, divided cuts and reciprocal shaft angles for a splinter-free joining edge.
- This creates a cylindrical finish for large material thicknesses (approx. 0.1 mm)

The Diamaster WF 499-2 jointing cutter is recommended for absolutely straight cutting surfaces (see Leitz supplier information).

Low-noise joining on narrow workpiece surfaces in climb and conventional milling (variable milling)

Machines used:

- Edge processing machines
- Copy milling machines

Information on milling equipment:

- Composite tool with mutual shaft angle for a splinter-free joining edge and a straight narrow surface
- Noise reduction up to 5 dB(A) and highly efficient collection of shavings (over 95%)

Routers

For processing using routers and machining centers, use solid hard metal twist (VHW) or diamond-tipped (DP) router bits. Clamp workpieces well – if necessary, use additional mechanical clamps to support the suction cups. For maximum stability and rigidity, it is recommended to use ThermoGrip shrink-fit jaw chucks instead of collet chucks.

Good results can only be achieved if the machine is sufficiently stiff. "Light" radial machines are unsuitable, stiff portal machines are ideal.

Format, groove and finish milling

When high cut quality is required. Z3 model for high feed rates.

Machines used:

- Routers with/without CNC control
- Machining centers
- Special milling machines with milling spindles for use with shaft tools

Information on milling equipment:

- Marathon laminate for increased tool life and reduced tendency to form a built-up edge
- Use after roughing cutters, cutting allowance: 1–2 mm mirror grinding on the rake surface for processing

Router cutters for formatting and grooving with ledge-free cut

Machines used:

- Routers with CNC control
- Machining centers
- Special milling machines with milling spindles for use with shaft tools

Information on milling equipment:

- Negative rake angle of the blade for splinter-free finish when grooving and workpiece clamping for smaller parts
- Can be re-sharpened 5 to 8 times with normal blunting.
- Short, stable cutting blade therefore particularly suited for grooves and shaping of abrasive and hard-to-cut materials.



4 16



4 17

CNC Processing

Fixing panels on a machine table

There are basically two ways to fix or tension Max Compact Interior panels on machine tables depending on the type of processing to be performed. Shape-milled or edge-machined plate panels on both sides: Fixing by means of punctual suction cups (the proper distance between the suction cups must be observed!). Shape-milled, single-edge panel parts, hole and free-form milling: Fixing by means of an MDF protective board (can be used several times). The following applies for both options: It must be ensured that the suction cups provide sufficient holding power for the work to be performed. If the fixing is not enough: Check the sealing levels (e.g., sealing rings of the suction cups)!

Spacing of the suction cups

As a rule, the material being processed should not be subjected to any vibrations. Therefore, it is important that the suction cups are placed at an appropriate distance from the freely protruding panel edge. The more suction cups and the smaller the distance from the protruding edge, the cleaner the milling pattern. As a rule of thumb: Grids of max. 300 mm with a maximum distance from the free protruding edge of the panel of no more than 30 mm. An MDF protective board (e.g., 19 mm thick) provides the best results due to full-surface vacuum fixation on the machine table.

Choice of machining tool

The Max Compact Interior panel can be machined with solid carbide (VHM) as well as diamond (PCD) milling tools. The basic prerequisites for a clean milling pattern and a long service life are vibration-free tool holders and spindles. NOTE: The ball bearings must be properly maintained!

Diamond tools have proven particularly suitable for processing a large amount of panels or a high number of running meters. Smooth-running milling cutters with a shank diameter of min. 10 mm in combination with straight continuous DIA cutting edges are especially suitable for format milling. It is essential that the feed rate and the cutting speed be adjusted for the specific job and cutter based on the material being processed. We recommend always consulting the tool supplier (see table of guide values for sizing, drilling, etc.).

Clamping system of the milling tool

It is essential that the spindle be centered in the chuck to ensure the smooth running of the milling cutter. The more centered and play-free the milling cutter can be clamped in place, the better the result. Most machines are equipped with common tool holders such as collets, hydro grips or shrink chucks. For the professional CNC machining of larger jobs, a hydro grip tool holder or shrink chuck is recommended as they guarantee the best tool clamping. It is important to ensure the proper maintenance of all moving parts such as plain and ball bearings in order to avoid vibrations!

Extraction

The extraction or the extraction power must be adjusted accordingly for the material being processed to ensure that all the shavings are optimally removed. If the extraction is not strong enough, there is a risk of heat development. This is due to shavings that remain between the cutter and the panel edge. If the cutter can no longer eject the material, high friction and burn marks will occur at the edge of the panel.

CNC machining by Fundermax

Fundermax Compact Elements offers processing of Max Compact Interior, Max Compact Exterior, Max HPL and m.look. Please direct inquiries to the appropriate Customer Service Center (KSC) team.

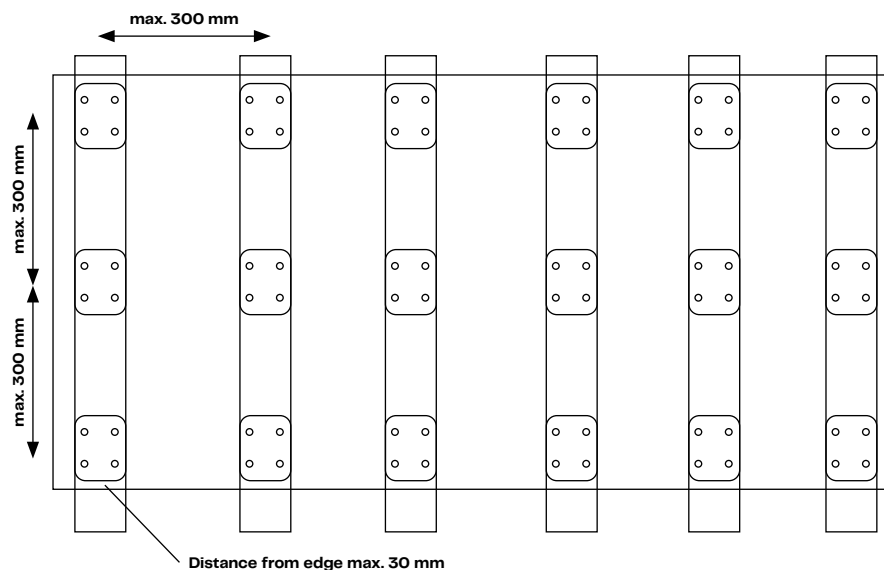

Edges and grooves

Grooved edges on Max Compact Interior panels should always be beveled, not sharp-edged! This spares the corners of the machine (indexable inserts) and prevents a notch effect. The service life can decrease depending on the height adjustment, the machine type and form, the cutting requirements and support material. For high volume production, the use of diamond-tipped machines should be considered.

Inner notches and cut-outs

Always round off corners – sharp-edged corners lead to cracking. The inner radius should be kept as large as possible (minimum radius 5 mm). For inner notches and milling grooves with a side length of over 250 mm, the radius must be gradually increased in line with the side length. Inner notches can be made with the milling cutter or pre-drilled before the cutout is sawn out from hole to hole.

All edges must be ripple free. If sharp-edged corners are required, this can be achieved by combining cut Max Compact Interior panels. The suitable cutting, milling and drilling machines are described in the previous sections.

Sanding the edges

With the usual machines, grain 100–120. Also possible by hand with sandpaper or scraper. Embed black panel edges with silicone-free oil to provide uniform color.

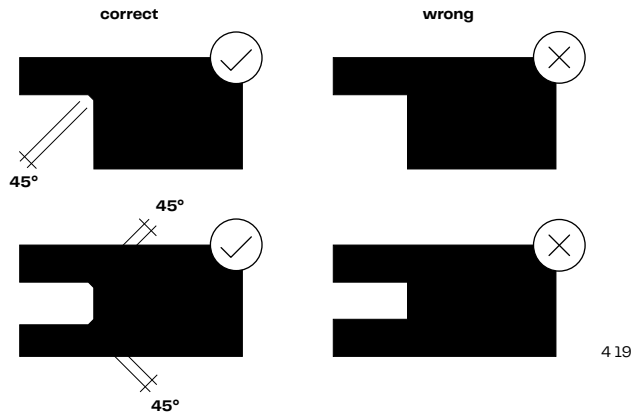

4 19

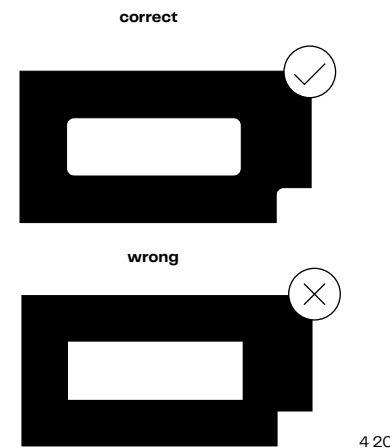

4 20

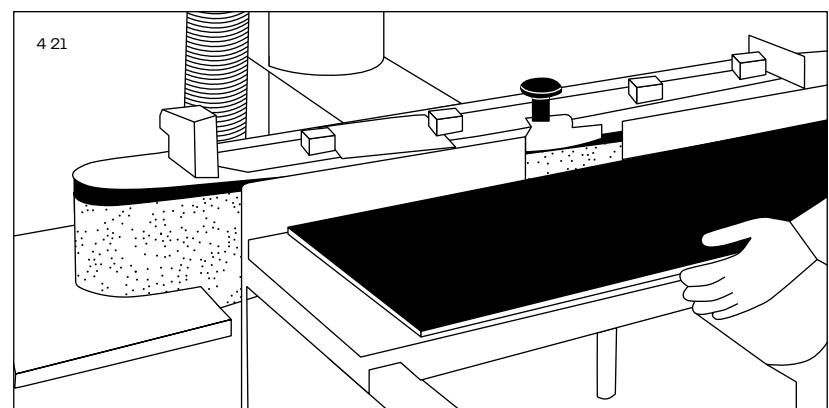

- 4 19 Grooved edges Max Compact Interior panels
- 4 20 Milling grooves Max Compact Interior panels
- 4 21 Edges Max Compact Interior panels

Examples of edge and corner designs

For Max Compact Interior panels no edge protection is necessary.

Current data sheet of the processing options can be found under www.fundermax.com.

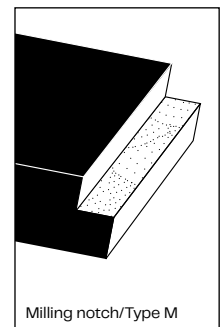
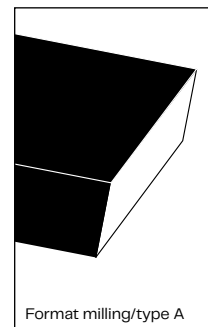
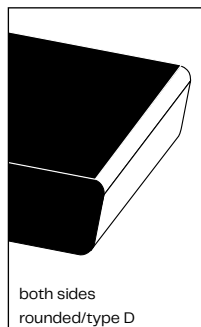
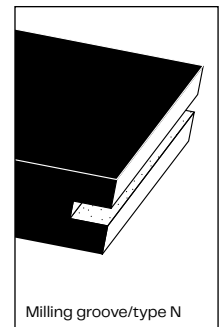
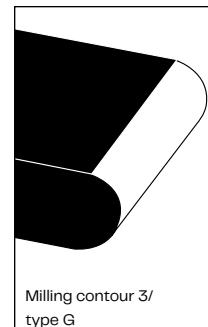
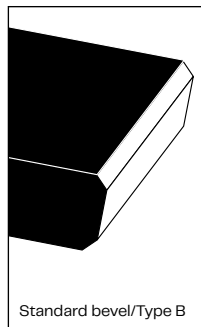

Tool suppliers

Austria

Leitz GmbH & Co. KG
Leitzstraße 80
A-4752 Riedau
Tel: +43 (0)7764 8200-0
Fax: +43 (0)7764 8200-111
office.riedau@rie.leitz.org
www.leitz.org

OERTLI-LEUCO Werkzeuge GmbH
Industriepark Runa
A-6800 Feldkirch
Tel: +43 (0)5522 75787-0
Fax: +43 (0)5522 75787-3
info@oertli.at
www.oertli.at

Germany

Ledermann GmbH & Co. KG
Willi-Ledermann-Straße 1
D-72160 Horb am Neckar
Tel: +49 (0)7451 93-0
Fax: +49 (0)7451 93-270
info@leuco.com
www.leuco.com

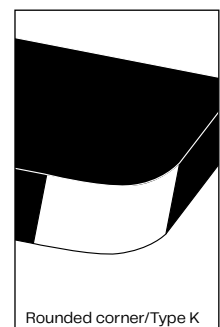
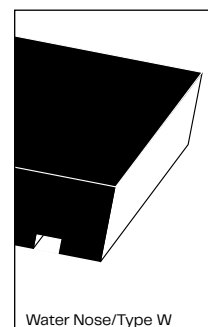
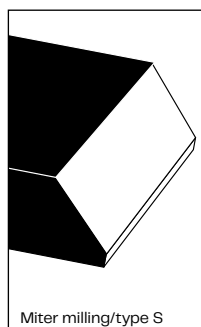
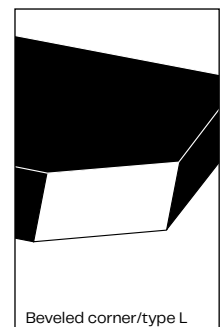
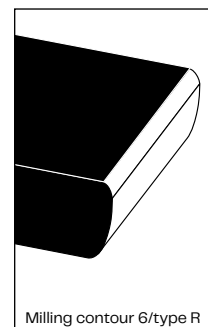
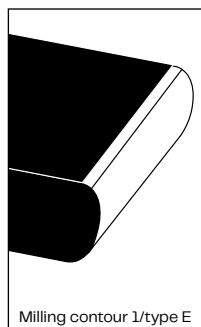

Drilling

4 22

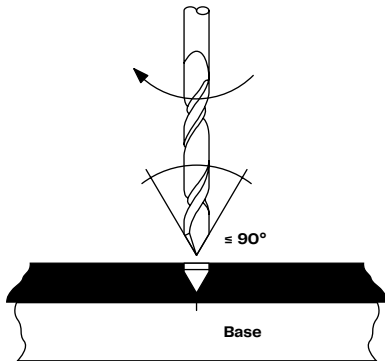

4 23

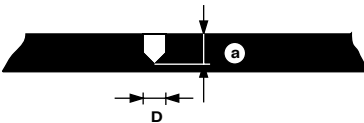

4 24



4 25

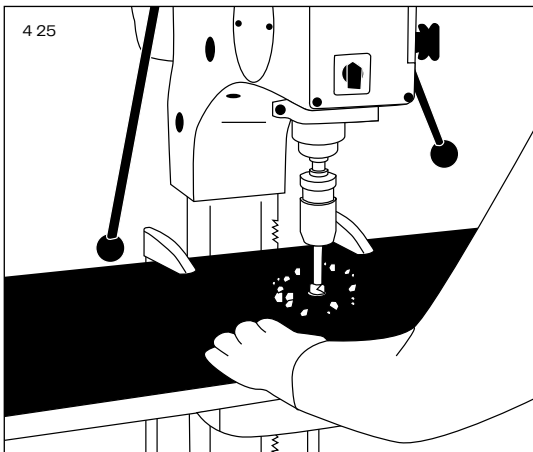

Solid hard metal twist (VHW) or dowel drills are used for drilling. In machining centers, the use of the main spindle instead of the drilling beams for a rpm of 2000 – 4000 min⁻¹ and a feed rate of 1.5 – 3 m/min, is recommended. Select the exit speed of the drill so that the melamine surface is not damaged. Shortly before the drill exits the workpiece in full diameter, the feed rate must be reduced by 50%. When drilling through-holes, the counter-pressure should be built up using hardwood or equivalent material to prevent break-offs of the melamine surface.

This is best achieved with drills for plastics, i.e. twist drills with an acute angle of $\leq 90^\circ$. They have a large pitch with large chip space, the steep tip allows drilling of through holes and they cut cleanly through the back of the material.

Note for blind holes perpendicular to the panel plane:

- Pilot hole diameter (D) = Screw diameter minus approx. 1 thread depth
- Drilling depth (a) = Panel thickness minus 2 mm after deduction of all tolerances
- Screw-in depth = drilling depth minus 1 mm

Note for blind holes parallel to the panel level:

- The residual thickness (b) of the Max Compact Interior panel must be at least 3 mm after deducting all tolerances.
- Select diameter of holes so that there is no splitting of the panel when screwing in the screws.
- Metal sheet and chip board screws are suitable.
- For more stability, make sure there is a minimum depth of 25 mm.
- It is imperative that tests to establish the correct drill diameter are carried out.

4 22 Twist drills with a point angle of $\approx 90^\circ$.

4 23 Screws perpendicular to the panel plane

4 24 Screws parallel to the panel plane

4 25 Box column drill

Universal drilling of blind and through-holes.

Machines used:

- Point-to-Point drilling machines
- Through-feed drilling machines
- CNC machining centers
- Box column drill
- Inlet fitting drilling machines
- Drilling units
- Hand drills

Information about the drill:

- Flat roof drill bits
- Shank diameter identical with blade diameter
- Adaptable for shaft-D 10 mm with reducing bush TB 110-0 or PM 320-0-25.

Tiered hinge drilling

Particularly for screw-in hinges in door manufacturing.

Machines used:

- CNC machining centers
- Drilling units
- Hand drills

Information about the drill:

- Model HW Z 2, 2-tiered
- 1st tier with roof drill bit

Drilling blind holes

In particular for dowel holes in cabinetry. Suitable for the tear-free drilling of blind holes in visible quality as well as the processing of panel materials.

Machines used:

- Point-to-Point drilling machines
- Through-feed drilling machines
- Inlet fitting drilling machines
- Drilling units
- CNC machining centers

Information about the drill:

- Roughing geometry with extremely clean cut
- Model HW-solid with highly wear resistant HW varieties
- High stability and long service life
- Polished chip space for minimal friction and feed force

Note:

In the case of manual drilling, better guidance can be achieved by pre-graining. Diamond-tipped drills are not suitable for Compact panels.

4 26



4 27



4 28



4 26 Leitz drill bit HW solid, Z 2

4 27 Leitz drill bit shaft 10 mm

4 28 Leitz drill bit shaft 10 mm

Screws

Screws should never come into contact with the edges of drillholes. They must have clearance on all sides so that the material can adapt to temperature and moisture fluctuations. In this way, the formation of cracks around the holes as well as panel warping, is avoided.

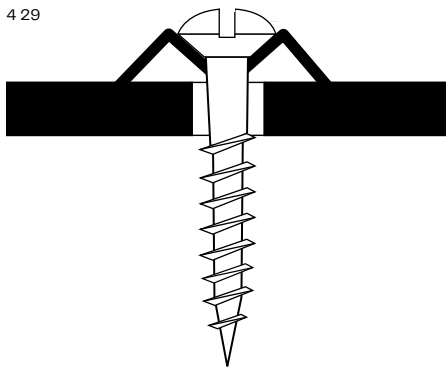

For lens head screws: use the underlay rosettes!

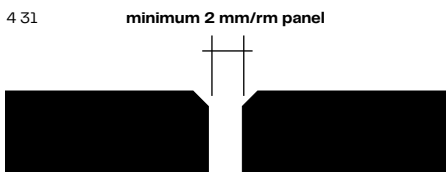
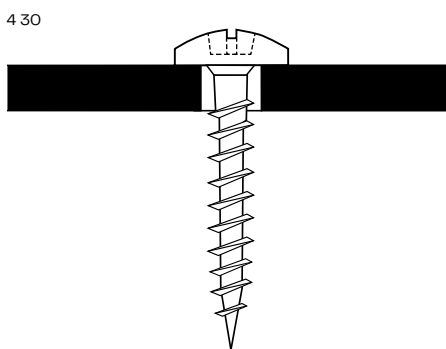

Attention to V-joints an expansion clearance on plat fragmentations!

Glued corner joints

In order to increase the adhesive surface, special bevel sections can be milled (Leitz) or joints with groove or external springs (Compact strips) can be produced.

During the adhesive process, it must be ensured that both bonded panels are joined in the same running direction.

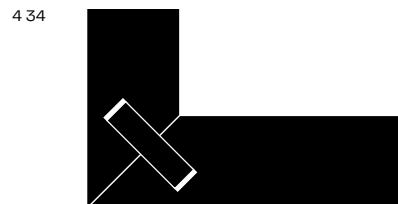
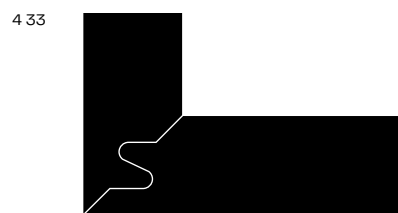
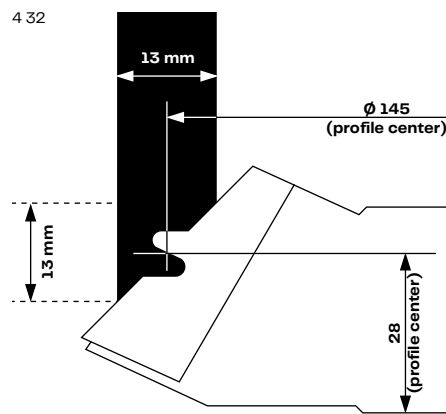

- 4 29** Lens head screw with underlay rosette
- 4 30** Rounded head screw covers slide points
- 4 31** V-joints with expansion clearance
- 4 32** Leitz profile cutterhead Pro 610-1-5
- 4 33** Corner joint with Leitz profile cutter
- 4 34** Corner joint with grooves and external springs

Gluing

Adhesive joints should be carried out in such a way that dimensional changes of the panels are allowed. The panels must only be bonded in the same running direction and conditioning, otherwise tensions may occur (tip: identify decorative design before cutting). Max Compact Interior panels have twice as much shrinkage and swelling room breadth wise than lengthwise. If adhesive joints are put under frequent pressure, they should be supported using mechanical joints.

Adhesives:

- Dispersion adhesives (e.g., PVAc glues = casein condensation)
- Resin adhesives (e.g., urea, resorcinol and phenolic glues)
- Contact adhesives (e.g., polychloroprene adhesives)
- Reactive adhesives (e.g., epoxy, unsaturated polyester, polyurethane adhesives)
- Hot melt adhesives (for edge banding, based on EVA, polyamide or polyurethane)

Gluing Max Compact Interior panels one below the other

Stiff adhesive joints – Reactive adhesives:

- Polyurethane
- Epoxy glue

Please note: These adhesives foam up and the surface of the panels must be cleaned before the adhesive dries. Once it dries only a mechanical cleaning is possible, which can damage the surface of the panel.

Dispersion adhesives (white glue) and condensation adhesives (PVA glues) are not suitable.

Elastic adhesive joints – PUR adhesive:

- Würth "glues and seals"
- Sikaflex 252
- Teroson – Terostat 92
- Dinitrol 600
- Dinitrol 605
- Dinitrol F500
- Dinitrol 410 UV Plus
- Fuller ICEMA 101/25 + curing agent 7

These adhesives are also suitable for supporting mechanical joints.

Gluing of Max Compact Interior with wood

After sanding the Max Compact panels, they can be bonded to wood materials using high-quality PVAc glues. Prerequisite: material must be able to absorb glue moisture during the setting process.

Glue application process

The Max Compact Interior panel, as well as the material to be glued, must be thoroughly cleaned before gluing so that there are no dust, grease, oil and sweat stains or coarse particles that can mark the surface after gluing. Ambient climate during bonding: 15–25 °C and 50–60% relative humidity.

The glue joint quality must be selected according to the bonding quality of the substrate and the load. Increased water resistance of the glue joint does not increase the water resistance of the substrate material!

The specifications of the selected adhesive manufacturer must be observed. It is always recommended to test the glue first under local conditions. Observe occupational health and safety regulations when working with adhesives, solvents and hardeners.

Press temperature

Tension-free composite elements can be produced most reliably at pressing temperatures of 20 °C, i.e. room temperature. Higher temperatures allow a reduction in the setting time. However, since the temperature also leads to dimensional changes that may vary between the Max Compact Interior panels and the other materials 60°C should not be exceeded in order to avoid increased stress which can lead to the distortion of the elements.

5 Chemical resistance

“Quality is always the best foundation.”

(Patricia Z., practice manager)



Max Compact Interior and Star Favorit panels

These products have hygienic, pore-free sealed surfaces made of melamine resin. Besides their excellent mechanical values, the Max Compact Interior and Star Favorit panels mean a high temperature resistance, easy cleaning and a good resistance to chemicals. With the Max Compact Interior panels, the stain resistance requirements in accordance with EN 438 are met and the Star Favorit panels are stain resistant in accordance with EN 14323.

Resistance to:

- Lab and technical chemicals
- Solvents
- Disinfectants
- Dyes (certain types)
- Cosmetics

Particular attention must be paid to the careful processing of Max Compact Interior panels, as certain requirements may be imposed due to the particular field of use when constructing certain laboratory and medical facilities. The use of the Max Resistance² laboratory panels is recommended.

Max Compact Interior and Star Favorit panels are resistant against many chemicals. However, several chemicals may still corrode the surface.

The following lists give an overview (without claiming to be complete) of the resistance of the panels (at room temperature) to the action of frequently occurring substances (solid, dissolved, liquid, gaseous). When using substances that are not listed, we ask that you enquire further.

To ensure you chose the right product, we strongly recommend that you clearly specify the chemical resistance requirements in advance.

Max Compact Interior panels

No damage

Max Compact Interior panels are resistant against the following substances and agents. These elements do not have an impact on the surface area, even after prolonged exposure (16 hours).

Substance	Chemical formula	Substance	Chemical formula	Substance	Chemical formula
Aceton	CH ₃ COCH ₃	Boric acid	H ₃ BO ₃	Gypsum	CaSO ₄ ·2H ₂ O
Activated carbon		Butyl acetate	CH ₃ COOC ₄ H ₉	Glucose	C ₆ H ₁₂ O ₆
Alum solution	KAl(SO ₄) ₂ ·12H ₂ O	Butyl alcohol	C ₄ H ₉ OH	Glycerine	CH ₂ OH-CHOH-CH ₂ OH
Aldehydes	RCHO	Cadmium acetate	Cd(CH ₃ COO) ₂	Glycerol	NH ₂ CH ₂ COOH
Alcohols	ROH	Cadmium sulfate	CdSO ₄	Glycol	HOCH ₂ -CH ₂ OH
Alcohols, primary	RCH ₂ OH	Calcium carbonate (chalk)	CaCO ₃	Graphite	C
secondary	RR'CHOH	Calcium chloride	CaCl ₂	Uric acid	C ₅ H ₄ N ₄ O ₃
tertiary	RR'R''COH	Calcium hydroxide	Ca(OH) ₂	Urea solution	CO(NH ₂) ₂
Alcohols, primary		Calcium nitrate	Ca(NO ₃) ₂	Yeasts	
Aluminum chloride	AlCl ₃ .aq.	Carbolic acid	C ₆ H ₅ OH	Heparin	
Aluminum sulfate	Al ₂ (SO ₄) ₃	Chloral hydrate	CCl ₃ CH(OH) ₂	Heptanol	C ₇ H ₁₅ OH
Formic acid up to about 10%	HCOOH	Chlorobenzene	C ₆ H ₅ Cl	Hexane	C ₆ H ₁₄
Amide	RCONH ₂	Chloroform	CHCl ₃	Hexanol	C ₆ H ₁₃ OH
Amines, primary	RNH ₂	Cholesterol	C ₂₇ H ₄₆ OH	Hydroquinone	HOC ₆ H ₄ OH
secondary	(RR')NH	Cyclohexane	C ₆ H ₁₂	Hypophysin	
tertiary	(RR'R'')N	Cyclohexanol	C ₆ H ₁₁ OH	Imido "Roche"	
Ammonia	NH ₄ OH	Detergents		Immersion oil	
Ammonium chloride	NH ₄ Cl	Dextrose	C ₆ H ₁₂ O ₆	Inositol	C ₆ H ₆ (OH) ₆
Ammonium sulfate	(NH ₄) ₂ SO ₄	Digitonin	C ₅₆ H ₉₂ O ₂₉	Insecticides	
Ammonium thiocyanate	NH ₄ SCN	Dimethylformamide	HCON(CH ₃) ₂	Isopropanol	C ₃ H ₇ OH
Amylacetate	CH ₃ COOC ₅ H ₁₁	Dimethyl sulfoxide	(CH ₃) ₂ SO	Coffee	
Amyl alcohol	C ₅ H ₁₁ OH	Dioxane	C ₄ H ₈ O ₂	Potassium hydroxide solution up to about 10%	KOH
Aniline	C ₆ H ₅ NH ₂	Dulcitol	C ₆ H ₁₄ O ₆	Aluminum potassium sulfate	KAl(SO ₄) ₂
Arabinose	C ₅ H ₁₀ O ₅	Glacial acetic acid	CH ₃ COOH	Potassium bromate	KBrO ₃
Ascorbic acid	C ₆ H ₈ O ₆	Soil		Potassium bromide	KBr
Asparagine	C ₄ H ₈ N ₂ O ₃	Acetic acid	CH ₃ COOH	Potassium carbonate	K ₂ CO ₃
Aspartic acid	C ₄ H ₇ NO ₄	Ethyl acetate	CH ₃ COOC ₂ H ₅	Potassium chloride	KCl
p-aminoacetophenone	C ₈ H ₉ NO	Acetic acid isoamyl ester	CH ₃ COOC ₅ H ₁₁	Potassium hexacyanidoferrate	K ₄ Fe(CN) ₆
Baker's yeast		Ester	RCOOR'	Potassium iodate	KIO ₃
Barium chloride	BaCl ₂	Ethanol	C ₂ H ₅ OH	Potassium sodium tartrate	KNaC ₄ H ₄ O ₆
Barium sulfate	BaSO ₄	Ether	ROR'	Potassium nitrate	KNO ₃
Benzaldehyde	C ₆ H ₅ CHO	Ethyl acetate	CH ₃ COOC ₂ H ₅	Potassium sulfate	K ₂ SO ₄
Benzoic acid	C ₆ H ₅ COOH	Ethylene dichloride (dichloroethylene)	C ₂ H ₂ Cl ₂	Potassium tartrate	K ₂ C ₄ H ₄ O ₆
Benzol	C ₆ H ₆	Paints		Carbol-Xylene	C ₆ H ₅ OH-C ₆ H ₄ (CH ₃) ₂
Benzidine	NH ₂ C ₆ H ₄ -C ₆ H ₄ NH ₂	Greases		Potato starch	
Biogel		Formaldehyde	HCHO	Casein	
Lead acetate	Pb(CH ₃ COO) ₂	Fructose	C ₆ H ₁₂ O ₆	Ketones	RR'CO
Lead nitrate	Pb(NO ₃) ₂	Fodder		Table salt	NaCl
Blood		Galactose	C ₆ H ₁₂ O ₆	Caffeine	
Blood group test serums		Gelatine		Coal	

Substance	Chemical formula	Substance	Chemical formula	Substance	Chemical formula
Cosmetics		Nickel sulfate	NiSO ₄	Standard II nutrient broth	
Cresol	CH ₃ C ₆ H ₄ OH	Nicotine	C ₁₀ H ₁₄ N ₂	Starch	
Cresylic acid	CH ₃ C ₆ H ₄ COOH	-Nitrophenol	C ₆ H ₄ NO ₂ OH	Starch saline solution	
Copper sulfate	CuSO ₄ aq.	Nonne-Appelt-reagent		Stearic acid	C ₁₇ H ₃₅ COOH
Lactose	C ₁₂ H ₂₂ O ₁₁	Octanol	C ₈ H ₁₇ OH	Styrene	C ₆ H ₅ CH = CH ₂
Fructose	C ₆ H ₁₂ O ₆	Octyl alcohol	C ₈ H ₁₇ OH	Talcum	Mg ₃ Si ₄ O ₁₀ (OH) ₂
Lipstick		Olive oil		Tannin	C ₇₆ H ₅₂ O ₄₆
Lithium carbonate	Li ₂ CO ₃	Oleic acid	CH ₃ (CH ₂) ₇ CH = CH(CH ₂) ₇ COOH	Tea	
Magnesium carbonate	MgCO ₃	Organic solvents		Turpentine	
Magnesium chloride	MgCl ₂	Pandy's reagent		Carbon tetrachloride	CCl ₄
Magnesium sulfate	MgSO ₄	Paraffine	C _n H _{2n+2}	Tetrahydrofuran	C ₄ H ₈ O
Maltose	C ₁₂ H ₂₂ O ₁₁	Kerosene oil		Tetralin	C ₁₀ H ₁₂
Mannitol	C ₆ H ₁₄ O ₆	Pentanol	C ₅ H ₁₁ OH	Thiourea	NH ₂ CSNH ₂
Mannose	C ₆ H ₁₂ O ₆	Petroleum gasoline		Thymol	C ₁₀ H ₁₄ O
Seawater		Peptone		Thymol buffer solution	
Meso-inositol	C ₆ H ₆ (OH) ₆	Phenol and		Animal fodder	
Methanol	CH ₃ OH	Phenol derivatives	C ₆ H ₅ OH	Animal fats	
Milk, lactic acid	CH ₃ CHOHCOOH	Phenolphthalein	C ₂₀ H ₁₄ O ₄	Ink	
Lactose	C ₁₂ H ₂₂ O ₁₁	Polishing agents (creams & waxes)		Toluene	C ₆ H ₅ CH ₃
Mineral oils		Propanol	C ₃ H ₇ OH	Sound	
Nail polish		1,2-Propylene glycol	CH ₃ CHOHCH ₂ OH	Töpfer's reagent	
Nail polish remover		Pyridine	C ₅ H ₅ N	Dextrose	C ₆ H ₁₂ O ₆
Foodstuffs		Mercury	Hg	Trehalose	C ₁₂ H ₂₂ O ₁₁
Naphtol	C ₁₀ H ₇ OH	Raffinose	C ₁₈ H ₃₂ O ₁₅ ·5H ₂ O	Trichloroethylene	CHCl = CCl ₂
Naphtylamine	C ₁₀ H ₇ NH ₂	Rhamnose	C ₆ H ₁₂ O ₅ ·H ₂ O	Trypsin	
Sodium acetate	CH ₃ COONa	Castor oil		Tryptophan	C ₁₁ H ₁₂ N ₂ O ₂
Sodium carbonate	Na ₂ CO ₃	Rochelle salt		Urease	
Sodium chloride	NaCl	Cane sugar	C ₁₂ H ₂₂ O ₁₁	Urine	
Sodium citrate	Na ₃ C ₆ H ₅ O ₇ ·5H ₂ O	Soot		Vanillin	C ₈ H ₈ O ₃
Sodium diethyl barbiturate	NaC ₈ H ₁₁ N ₂ O ₃	Saccharose	= Cane sugar	Vaseline	
Sodium hydrogen carbonate	NaHCO ₃	Ointments		Water	H ₂ O
Sodium hydrogen sulfite	NaHSO ₃	Salicylaldehyde	C ₆ H ₄ OH-CHO	Watercolors	
Sodium hyposulfite	Na ₂ S ₂ O ₄	Salicylic acid	C ₆ H ₄ OHCOOH	Hydrogen peroxide 3%	H ₂ O ₂
Sodium nitrate	NaNO ₃	Saponin		Tartaric acid	C ₄ H ₆ O ₆
Sodium phosphate	Na ₃ PO ₄	Sulfuric acid	S	Xylo	C ₆ H ₄ (CH ₃) ₂
Sodium silicate	Na ₂ SiO ₃	Soap		Cedarwood oil thickened	
Sodium sulfate	Na ₂ SO ₄	Sorbitol	C ₆ H ₁₄ O ₆	Cement	
Sodium sulfide	Na ₂ S	Standard acetate solution		Zinc chloride	ZnCl ₂
Sodium sulfite	Na ₂ SO ₃	Standard I-Nutrient agar		Zinc sulfate	ZnSO ₄
Sodium tartrate	Na ₂ C ₄ H ₄ O ₆	Standard II Nutrient agar		Citric acid	C ₆ H ₈ O ₇
Caustic soda solution up to about 10%	NaOH	Standard I nutrient broth		Sugar and sugar derivatives	

Max Compact Interior panels

No damage under short exposure

Surfaces from Max Compact Interior panels remain unchanged when the following substances are spilled on them or if they are in contact for a short amount of time (removal within 10–15 minutes). Please note that the time of exposure is an important factor in the extent of corrosion on the HPL surfaces, even with diluted agents. As a result of the evaporation of the diluted material, the concentration of the substance increases over a period of time and the surfaces will be corroded, even though the concentration used will mostly be below those named in the following list. Focused sample tests are recommended.

Substance	Chemical formula	Substance	Chemical Formula
Formic acid over 10%	HCOOH	Varnishes and adhesives, chemically curing	
Amidosulfonic acid up to 10%	NH ₂ SO ₃ H	Methylene blue	C ₁₆ H ₁₈ O ₃
Aniline dyes		Millons reagent	OHg ₂ NH ₂ Cl
Inorganic acids up to 10%		Sodium hydrogen sulfate	NaHSO ₄
Arsenic acid up to 10%	H ₃ AsO ₄	Sodium hypochlorite	NaOCl
Boric acid	H ₃ BO ₃	Sodium thiosulfate	Na ₂ S ₂ O ₃
Iron (II) chloride solution	FeCl ₂	Sodium hydroxide solution over 10%	NaOH
Iron (III) chloride	FeCl ₃	Nylander's reagent	
Esbach's reagent		Oxalic acid	COOHCOOH
Fuchsin solution	C ₁₉ H ₁₉ N ₃ O	Phosphoric acid up to 10%	H ₃ PO ₄
Hair dyes and bleaches		Picric acid	C ₆ H ₂ OH(NO ₂) ₃
Iodine solution	I	Mercury (II) chromate	HgCr ₂ O ₇
Antiliming agents		Nitric acid up to 10%	HNO ₃
Potash lye over 10%	KOH	Hydrochloric acid up to 10%	HCl
Potassium chromate	K ₂ CrO ₄	Sulfuric acid up to 10%	H ₂ SO ₄
Potassium dichromate	K ₂ Cr ₂ O ₇	Sulfurous acid up to 10%	H ₂ SO ₃
Potassium hydrogen sulfate	KHSO ₄	Silver nitrate	AgNO ₃
Potassium iodide	KI	Sublimate solution (= mercury chloride)	HgCl ₂
Potassium permanganate	KMnO ₄	Hydrogen peroxide over 3–30% (perhydrol)	H ₂ O ₂
Crystal violet (Gentian violet)	C ₂₄ H ₂₈ N ₃ Cl		

High risk of damage

The following chemicals destroy the Max Compact Interior panel surfaces. They must be removed immediately, as they could also leave behind dull spots and coarseness even with a very short exposure time.

Substance	Chemical formula
In concentrations greater than 10%: Amidosulfonic acid	NH ₂ SO ₃ H
Inorganic acids, e.g.: Arsenic acid	H ₃ AsO ₄
Hydrogen bromide	HBr
Chromic sulfuric acid	K ₂ Cr ₂ O ₇ + H ₂ SO ₄
Hydrofluoric acid	HF
Nitrohydrochloric acid	HNO ₃ : HCl = 1 : 3
Phosphoric acid	H ₃ PO ₄
Nitric acid	HNO ₃
Hydrochloric acid	HCl
Sulfuric acid	H ₂ SO ₄

Aggressive gases

Frequent exposure to the following aggressive gases and vapors causes the Max Compact Interior surface to change:

Substance	Chemical formula
Bromine	Br ₂
Chlorine	Cl ₂
Nitrose fumes	N _x O _y
Sulfur dioxide	SO ₂
Acid vapors	

Max Compact Interior Plus

Max Resistance² (lab plate)

Sterilizability

Thanks to their excellent surface area, Max Compact Interior Plus panels are as easy to clean and just as easy to sterilize as, for example, stainless steel or OP tiles.

24 h chemical resistance test

Concentration of household solvents (decor independent)

Substance	Concentration
Hydrochloric acid	10%
Phosphoric acid	10%
Acetic acid	10%
Sodium hypochlorite	13%
Caustic soda	25%
Ammonia	25%

The product not only achieves SEFA3 standards for chemical resistance of horizontal laboratory worktops, but significantly exceeds them. Even hydrofluoric acid and highly concentrated nitric acid do not damage the panel.

Test procedure

The chemical resistance tests were carried out in a SEFA certified laboratory according to test method SEFA3-2010 Sec. 2.1. (24-hour exposure). Detailed information and results are available in the official test reports.

Results

Fundermax Resistance² passed the 24-hour endurance test and is proven suitable for use in laboratories. The product clearly exceeds the SEFA test criteria, as all its scores are better than 3.

Evaluation

- No influence (0):
No detectable change in the material surface
- Excellent (1):
Slightly detectable change in color or gloss, but no change in functionality or service life of the surface
- Good (2):
A clearly discernible change in color or gloss, but no significant impairment of surface life
- Fair (3):
Objectionable change in appearance due to discoloration or traces of etching, which may lead to deterioration of function in the long term

Acceptance criteria

To be approved as laboratory grade surfaces, tested materials should receive no more than four Level 3 ratings.

Substances	Evaluation			
	0	1	2	3
	No effect	Excellent	Good	Fair
Acids				
Acetic acid 99%	○			
Dichromate acid 5% ²⁾	○			
Chromic acid 60%	○			
Methanoic acid 90% ²⁾	○			
Hydrochloric acid 37%	○			
Hydrofluoric acid 48%		○		
Nitric acid 20%	○			
Nitric acid 30%	○			
Nitric acid 70% ²⁾			○	
Phosphoric acid 85%	○			
Sulfuric acid 33%	○			
Sulfuric acid 77%	○			
Sulfuric acid 96%		○		
Sulfuric acid 77% Nitric acid 70% (1 : 1)			○	
Alkali				
Ammonium hydroxide 28%	○			
Sodium hydroxide 10%	○			
Sodium hydroxide 20%	○			
Sodium hydroxide 40%	○			
Sodium hydroxide flakes	○			
Salts and halogens				
Saturated zinc chloride solution	○			
Saturated silver nitrate solution	○			
Tincture of iodine ¹⁾		○		

Substances	Evaluation			
	0	1	2	3
	No effect	Excellent	Good	Fair
Organic Chemicals				
Cresol	○			
Dimethylformamide	○			
Formaldehyde 37%	○			
Furfural ¹⁾		○		
Gasoline	○			
Hydrogen peroxide 3%	○			
Hydrogen peroxide 30% ²⁾	○			
Phenol 90%		○		
Saturated sodium sulfide solution	○			
Solvents				
Acetone ²⁾	○			
Amylacetate	○			
Benzol	○			
Butyl alcohol	○			
Carbon tetrachloride	○			
Chloroform ²⁾	○			
Dichloroacetic acid ²⁾		○		
Dioxane	○			
Diethyl ether	○			
Ethyl acetate ¹⁾	○			
Ethyl alcohol	○			
Methyl alcohol	○			
Methylene chloride	○			
Methyl ethyl ketone	○			
Xylene ¹⁾	○			



Test results may vary depending on decor.
 1) Results on O082
 2) Results on O085

Star Favorit

No damage

Substance	Chemical formula	Substance	Chemical Formula
Aceton	CH_3COCH_3	Methanol	CH_3OH
Activated carbon		Milk, lactic acid	$\text{CH}_3\text{CHOHCOOH}$
Alum solution	$\text{KAl}(\text{SO}_4)_2 \cdot 12\text{H}_2\text{O}$	Nail polish	
Aldehydes	RCHO	Nail polish remover	
Alcohols	ROH	Sodium chloride	NaCl
Alcohols, primary	RCH_2OH	Caustic soda solution up to about 10%	NaOH
secondary	$\text{RR}'\text{CHOH}$	Octanol	$\text{C}_8\text{H}_{17}\text{OH}$
tertiary	$\text{RRR}'\text{COH}$	Octyl alcohol	$\text{C}_8\text{H}_{17}\text{OH}$
Ammonia	NH_4OH	Olive oil	
Benzol	C_6H_6	Oleic acid	$\text{CH}_3(\text{CH}_2)_{17}\text{CH} = \text{CH}(\text{CH}_2)_{17}\text{COOH}$
Butyl acetate	$\text{CH}_3\text{COOC}_4\text{H}_9$	Organic solvents	
Butyl alcohol	$\text{C}_4\text{H}_9\text{OH}$	Paraffine	$\text{C}_n\text{H}_{2n+2}$
Cyclohexane	C_6H_{12}	Kerosene oil	
Cyclohexanol	$\text{C}_6\text{H}_{11}\text{OH}$	Pentanol	$\text{C}_5\text{H}_{11}\text{OH}$
Ethanol	$\text{C}_2\text{H}_5\text{OH}$	Petroleum gasoline	
Ether	ROR'	Propanol	$\text{C}_3\text{H}_7\text{OH}$
Ethyl acetate	$\text{CH}_3\text{COOC}_2\text{H}_5$	Soap	
Greases		Tea	
Formaldehyde	HCHO	Turpentine	
Glycerine	$\text{CH}_2\text{OH}-\text{CHOH}-\text{CH}_2\text{OH}$	Carbon tetrachloride	CCl_4
Graphite	C	Animal fats	
Yeasts		Ink	
Heptanol	$\text{C}_7\text{H}_{15}\text{OH}$	Toluene	$\text{C}_6\text{H}_5\text{CH}_3$
Hexane	C_6H_{14}	Urine	
Hexanol	$\text{C}_6\text{H}_{13}\text{OH}$	Water	H_2O
Isopropanol	$\text{C}_3\text{H}_7\text{OH}$	Watercolors	
Coffee		Tartaric acid	$\text{C}_4\text{H}_6\text{O}_6$
Potassium hydroxide solution up to about 10%	KOH	Xylol	$\text{C}_6\text{H}_4(\text{CH}_3)_2$
Ketones	$\text{RR}'\text{CO}$	Citric acid	$\text{C}_6\text{H}_8\text{O}_7$
Lipstick			

High risk of damage

The chemicals listed can destroy the Star Favorit surface. They must be removed immediately, as they will leave matt spots even after a very short exposure time.

Substance	Chemical formula
In concentrations above about 10%: Amidosulfonic acid	$\text{NH}_2\text{SO}_3\text{H}$
Inorganic acids, e.g.: Arsenic acid	H_3AsO_4
Hydrogen bromide	HBr
Chromic sulfuric acid	$\text{K}_2\text{Cr}_2\text{O}_7 + \text{H}_2\text{SO}_4$
Hydrofluoric acid	HF
Nitrohydrochloric acid	$\text{HNO}_3; \text{HCl} = 1:3$
Phosphoric acid	H_3PO_4
Nitric acid	HNO_3
Hydrochloric acid	HCl
Sulfuric acid	H_2SO_4

Gases

Exposure to the following aggressive gases and vapors will cause the Star Favorit surface to change.

Substance	Chemical formula
Bromine	Br_2
Hydrogen bromide	HBR
Chlorine	Cl_2
Chromic sulfuric acid	$\text{K}_2\text{Cr}_2\text{O}_7 + \text{H}_2\text{SO}_4$
Hydrofluoric acid	HF
Nitrohydrochloric acid	$\text{HNO}_3 + \text{HCl} = 1:3$
Nitrose fumes	N_xO_y
Sulfur dioxide	SO_2
Sulfuric acid	H_2SO_4
Acid vapors	

6 Cleaning



“Flawlessness is the most beautiful goal.”

(Matteo V., Architect)

Cleaning recommendation for compact and laminated panels, Star Favorit and Star Favorit Superfront

For unknown stains: perform basic cleaning and, if necessary, cleaning procedures A to G in sequence until the desired result is achieved. When cleaning with solvents: observe accident prevention regulations. Open windows. No open flames!

- **Basic cleaning:**
Clean surface with pure hot water, soft sponge, cloth or brush (e.g., nylon brush) – DO NOT scrub!
- **Cleaning procedure A:**
Same as basic cleaning, in addition use standard household cleaners without abrasives (e.g., dishwashing detergent – Palmolive, Fairy etc.; window cleaner – Ajax, Frosch etc.).
- **Cleaning procedure B:**
If contamination cannot be removed with A, use soft soap–water solution (1 : 3). Give it more time to take effect, depending on the degree of soiling.
- **Cleaning procedure C:**
Same as basic cleaning, but organic solvents (e.g., acetone, alcohol, nitro thinner, turpentine) can also be used. In case of heavier contamination, remove contamination mechanically. CAUTION: Avoid scratches, use a plastic or wooden spatula. Not suitable for high-gloss or deep matt (anti-fingerprint) surfaces.
- **Cleaning procedure D:**
Same as basic cleaning, but clean additionally with commercially available disinfectants. Steam cleaning is possible. Take care of the supporting material (e.g., wood beams, wall cladding, insulation, etc.) – avoid soaking!
- **Cleaning procedure E:**
Remove immediately! If necessary, perform C and final cleaning procedure.

- **Cleaning procedure F:**
Dry surface with soft cloth or sponge. If this does not remove the contaminants: use silicone remover (e.g., from Molto).
- **Cleaning procedure G:**
Following basic cleaning, in the case of extremely persistent lime contamination, acidic cleaning agents (e.g., 10% acetic or citric acid) can also be used.
- **Final cleaning:**
Cleaning agents need to be completely removed with plenty of water to avoid streaking. Wash with pure hot water and dry the surface with absorbent cloth or a paper towel.

Type of stain	Cleaning procedure	Type of stain	Cleaning procedure
Bacteriological contamination	D	Ballpoint pen	C
Mordant	C	Synthetic resin	E
Pencil	A	Varnish (graffiti)	C
Blood	D	Lipstick	C
Wax polish	B	Marking pen	C
Sealant (like silicone)	F	Fitting foam	E
Dispersion (PVAc)	C	PU foam	E
Emulsion paint	C	Rust	G
Water soluble paint	A	Shoe polish	C
Grease, oil	A, B, C	Soap residue	A
Grease fat	A	Spray paints	C
Felt-tip pen	C	Dust	A
Fingerprints	A	Stamping ink	C
Fruit juice	A	Tea	A
Urea glue	E	Tar (cigarettes)	C
Hybrid adhesive	E	Urine	D
Coffee	A	Wax crayon	C
Limescale	G	Wax polish	C
Adhesive	C	Wax residue	C
Water soluble adhesive	A	Water marks	G
Excrement	D	Two-component adhesive	E
Germs	D	Two-component lacquer	E
Chalk	A		

7 Wall cladding

**“It’s best to build upon
beauty from within.”**

(Rica Z., planner)





Max Compact Interior panels offer numerous design options for fixed as well as removable wall and ceiling cladding. This model has proven ideal for train stations, airports, subways, open entrance areas, as well as for covered areas at shopping centers.

Ventilated wall cladding with Max Compact Interior panels

The product of choice for classic ventilated wall cladding: Max Compact Interior with black core (also available in F-quality). Rear ventilation ensures control of temperature and moisture, particularly if there is still construction moisture in the walls or climatic variations in adjacent rooms.

An unequal climate in front of and behind the materials can cause the panels to warp. The solution is to mount the panel on a substructure to create a distance from the wall and allow the air to circulate (min. 20 mm rear ventilation). Make the necessary openings for air to flow in and out with a minimum cross-section of 50.0cm²/m.

Joints between the panels can be closed, but do not hinder their expansion clearance. It must be ensured that the air supply from below and the extracted air above the panels are free and that the resulting moisture variations will be balanced out by the circulation of air. Always review and comply with state building codes.

Construction information

- An assembly of the wall cladding directly to the wall and the installation of wall elements without substructure and rear ventilation is not allowed.
- The fire protection requirements of the respective country and project must be observed.
- When mounting the panel it must be ensured that the rear ventilation functions properly. Air circulation is only possible if there are areas for air to enter and exit.
- Protect material from stagnated water. The panel material must always be allowed to dry.
- When bonding Compact Panels to each other (edge adhesives or bevels), make sure that all parts have the same running direction.
- Protect substructure against corrosion/rotting.
- Arrange joints/components of the panels in such a way that installations are easily accessible.
- All edges within reach must be beveled to form V-joints.

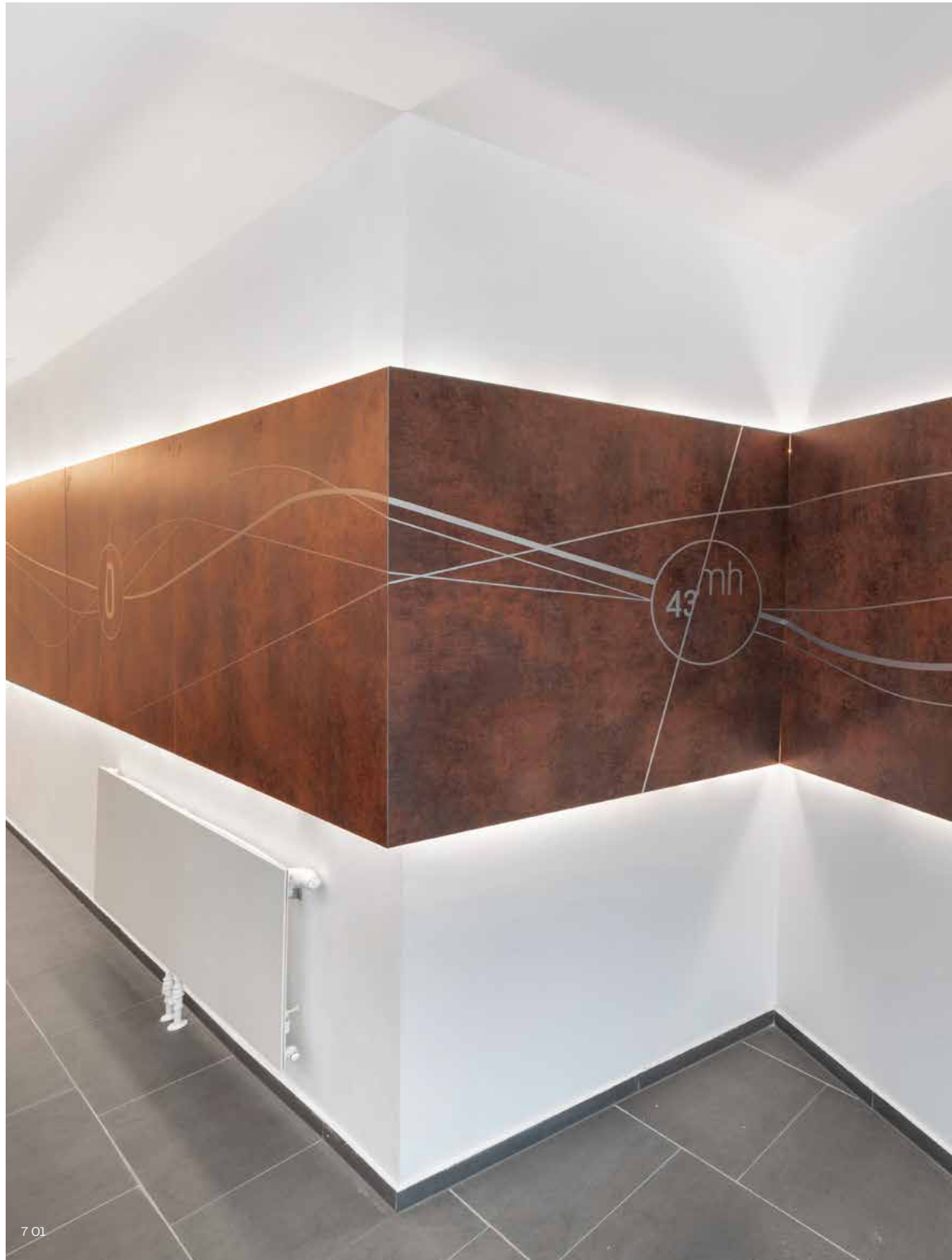

7 01 Decorative wall cladding
with rear ventilation

Fastening possibilities for wall cladding

There are different fastening possibilities for using Max Compact Interior panels as wall cladding. They can be screwed to wooden substructures, riveted to aluminum substructures or mounted with hanging strips made of wood or aluminum profiles.

Visible mechanical fastening

Note when using screws or rivets as fasteners: the center of the borehole in the substructure must correspond to the center of the borehole in the Compact panel. Start fastening the panels at the center of the panel and work outwards. Form sliding points and a maximum of one fixed point. Ensure sufficient expansion clearance. Joints between panels should be 2 mm per linear meter.

Sliding points

Depending on the necessary expansion clearance, drill the hole diameter for sliding points in the Compact panel larger than the diameter of the fastener. Shaft diameter of the fastener plus at least 2 mm per meter of cladding material starting from the fixed point. Fastener head must cover the drill hole. Set fasteners so that the panel can move. Set rivets with rivet gauge. The defined distance allows a movement of the parts in the borehole (clearance 0.3 mm). Do not overtighten screws. Do not use countersunk screws, use washers if required.



Fixed points

Fixed points serve to evenly distribute (halve) the movements due to swelling and shrinkage. The drill hole diameter in the Compact panel is just as big as the diameter of the fastener.

Drill one fixed point per panel as close as possible to the center of the element. Make all other fastening holes sliding points.

Distance from edge

The edge spacings must be maintained for reasons of stability and flatness. To accommodate the dimensional changes, make panel joints at least 2 mm per meter of panel.

The stability of the cladding is determined by the substructure and thickness of the cladding material.

Maximum fastening distances

Panel thickness	AS	AW
6 mm	600 mm	470,0 mm
8 mm	770,0 mm	620,0 mm
10 mm	920,0 mm	770,0 mm

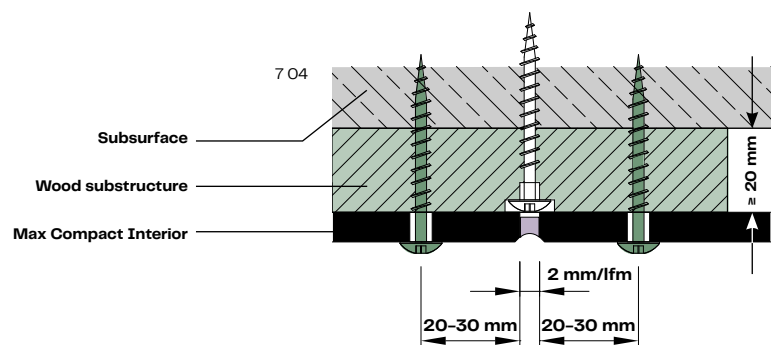
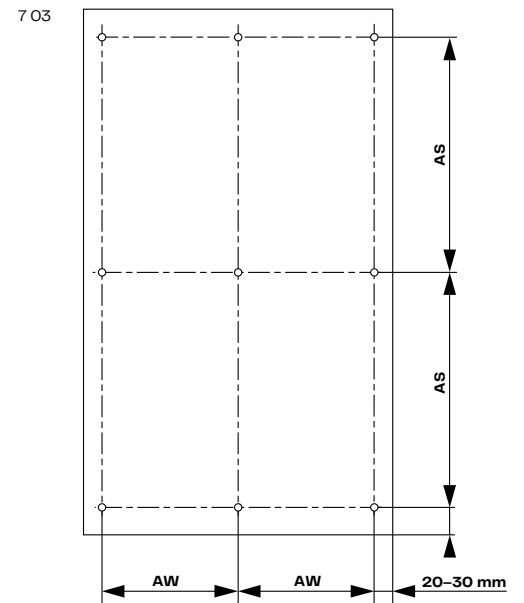

7 02 Wall cladding

7 03 Mounting distances

7 04 Type with rear ventilation and Max Compact Interior

Invisible mechanical fastenings

If you do not want the mounting fasteners to be visible, then Max Compact Interior panels can also be mounted on the wall with various suspension fasteners. The profiles can be attached by means of blind fasteners, screws and via spreader or threaded sleeves. Ideally, screws or sleeves with metal threads are used. The hole in the Compact panel must be predrilled one thread smaller.

It is important to space the horizontal suspension fastening in such a way that vertical rear ventilation is possible.

To avoid warping due to differences in tension, fixing strips must be spaced accordingly or made to slidable.

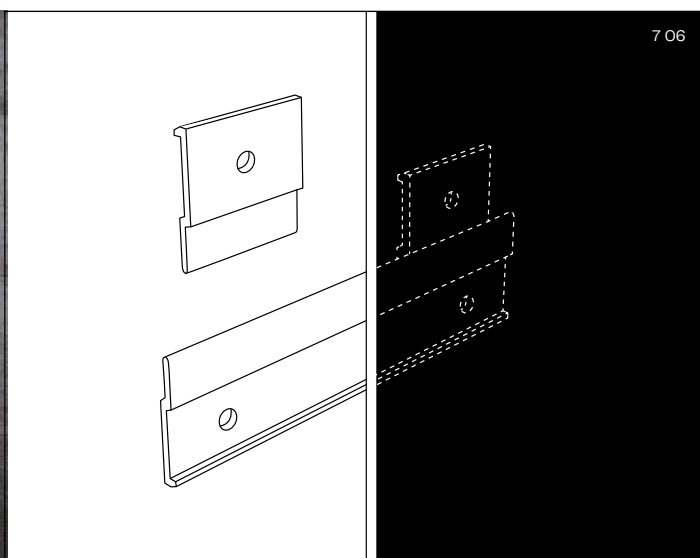

Ventilated wall cladding and wall protection with Lohr wall protection profiles

Panels provided with aluminum suspended shackles (thickness ≥ 10 mm) are hung in the flush mounted aluminum support frames (base and slope profiles). This allows for low depth of construction and easy disassembly.

This profile system is distributed by the company Helmut Lohr (see suppliers for wall claddings, page 67)

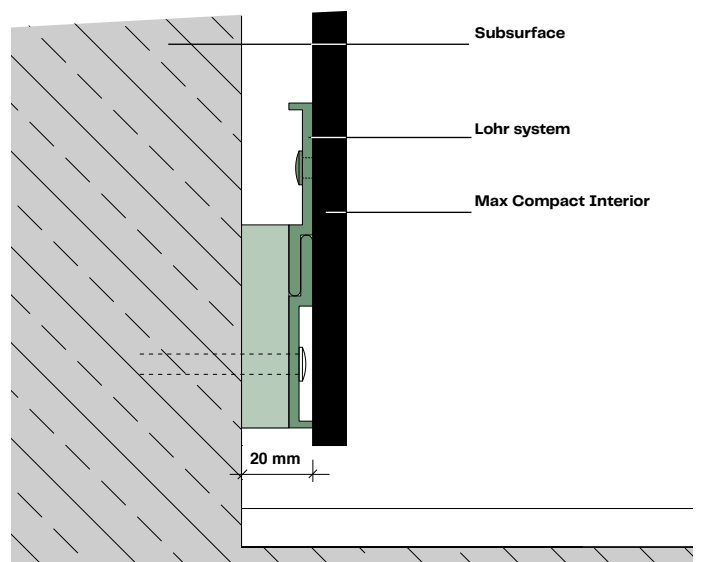
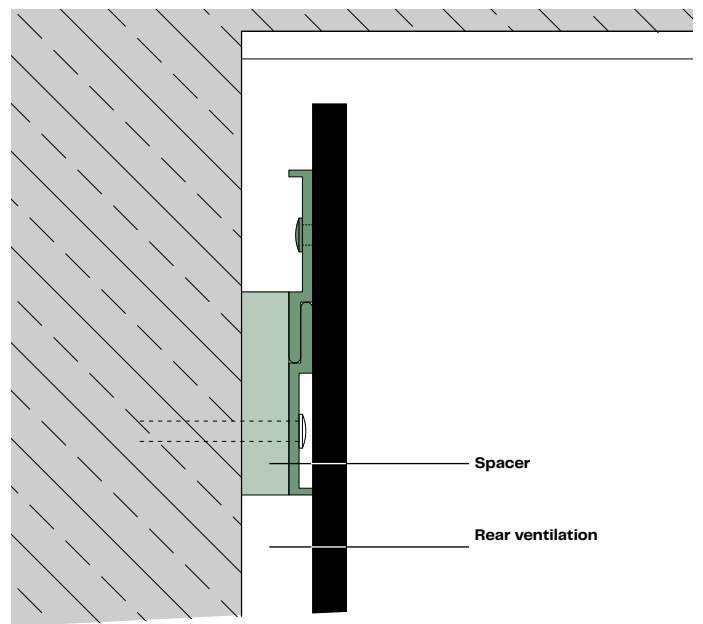

7 07

- 7 05 Wall cladding bathroom
- 7 06 Suspension fastening
- 7 07 Vertical section of ventilated wall cladding with Lohr wall protection profile

8 Non-ventilated wall cladding

“Success needs a system.”

(Lydia H., Builder)





Fundermax wall protection system – non-ventilated wall protection and floor-to-ceiling wall cladding

Due to increasing hygiene requirements, public buildings (e.g., hospitals, retirement homes, educational buildings, shopping centers, etc.) often need a wall protection system without rear ventilation. This is mounted directly or on a substructure system with metal brackets on the drywall, concrete or brick masonry. Subject to compliance with the requirements, the fastening can be visible or invisible. The wall protection system is available in a wide range of technical and design types – with and without frame profiles.

The wall protection system offers you:

- compatibility with all Max Compact Interior panels and m.look Interior panels;
- a long-lasting, sustainable wall design;
- flexible, multi-dimensional construction and design options;
- compliance with European fire protection requirements in accordance with building material classes EN 13501-1 B-s,d0 and A2-S1,d0;
- can be used in new construction and renovation;
- low component depth;
- clean connection details to other components;
- easy installation makes the system ideal for both small and large projects;
- environmentally friendly and tested by ÖkoKauf and baubook;
- meets even the strictest hygiene standards.

Prerequisites for the wall system to be secure and flat

- the wall must be dry (you are responsible for the measurement, wall moisture 0.4–1%) and kept dry after the installation period until commissioning;
- we recommend a vapor-tight, self-adhesive aluminum vapor barrier, model Alujet SE Tape PE on the subsurface;
- the panels must be conditioned to room climate;
- substructure and mounting distances are in accordance with the manufacturer's instructions and system specifications;
- there is at least 5 mm of space between the panel edges and end profiles/door frames;
- since they panels react to temperature and humidity fluctuation with an expansion of 2 mm per panel meter, the gaps in the panel joints must be adapted accordingly based on the panel format;
- panels are slotted and connected by a metal spring bracket at the panel joints;
- corner and angled elements should be designed with a metal profile as a system corner element;
- protect material from accumulating moisture – panel material must be allowed to dry;
- the wall protection system should not stand directly on the floor or a wall protection system with a metal base profile should be used;
- same production direction for all interconnected components (vertical with vertical and horizontal with horizontal);
- the fastening materials must be protected from corrosion;
- the use of a non-ventilated wall protection in shower cells is not recommended.



Type A: Wall protection system

The wall protection system from Max Compact Interior and m.look Interior creates a positive atmosphere and opens up new possibilities for architects and planners. With its numerous shapes and colors, it can be integrated into any design concept. The flexibility of the system is why it can be found in so many public areas.

The wall protection system can also be provided in building material class B-s1,d0 and A2-s1,d0 according to EN 13501-1.

Please observe the general requirements for non-rear ventilated wall cladding on page 54.

The wall protection system offers you:

- a durable wall design;
- flexible construction and design options;
- use in new buildings and renovations;
- closed surfaces and joints;
- a clean connection to other building components;
- easy installation – just right for large projects
- ÖkoKauf and baubook tested
- meet strict hygiene standards (please also observe the requirements of the respective country and project.)

Applications

- Foyers
- Lobbies
- Shopping centers
- Hospitals
- Retirement homes
- Doctor's offices
- Administrative buildings
- Schools
- Assembly rooms

Wall protection system suppliers

Brem Systeme GmbH – Wandschutz- und Handlaufsysteme

Boschstraße 7
D-94405 Landau
Tel: +49 (0)9951 6903-0
Fax: +49 (0)9951 6903-25
info@brem-systeme.de
www.brem-systeme.de

Duplex GmbH

Pfarrer-Steinberger-Straße 18
D-944312 Pilsting
Tel: +49 (0)9953 9305-0
Fax: +49 (0)9953 9305-38
info@system-duplex.com
www.system-duplex.com

Röhl GmbH

Friedrich-Koenig-Strasse 15-17
D-97297 Waldbüttelbrunn
Tel: +49 (0)931 40664-0
Fax: +49 (0)931 408009
info@roehl.de
www.roehlgmbh.de

Type B: non-ventilated wall panelling screwed on

Product names

- Max Compact Interior
- Max Compact Interior F-Quality

Product features:

- scratch resistant
- impact-resistant
- solvent resistant
- easy to clean

Building material class:

- Max Compact Interior: EN 13501-1 D-s2,d0
- Max Compact Interior F-Quality: EN 13501-1 B-s1,d0

Requirements

- the drill holes must be symmetrical, screw spacing 700 mm, distance from edge 50 mm;
- a third row of screws is used for panels with a height over 800 mm
- The hygiene requirements of the respective country or project must be observed.

Mounting

Start panel installation at the outer corners. Then mount individual grids or adjustment panels. Start fastening the panels at the center of the panel and work outwards.

Each panel should have sliding points and a maximum of one fixed point per panel (see Fig. 8 03, page 60). Ensure sufficient expansion clearance. Joints between panels should be ≥ 2 mm. Do not use countersunk screws to secure the panels (see Fig. 8 04, page 60)!



8 02 Wall cladding with wood decor

Mounting distances for 6 mm Max Compact

- Grid dimension: 700,0 mm
- Distance from edge: 50 mm

Drill hole diameter for Max Compact

- Fixed points: 6 mm
- Sliding points: 8 mm

The sliding point holes must be completely covered by the screw head (min. 12 mm head diameter).

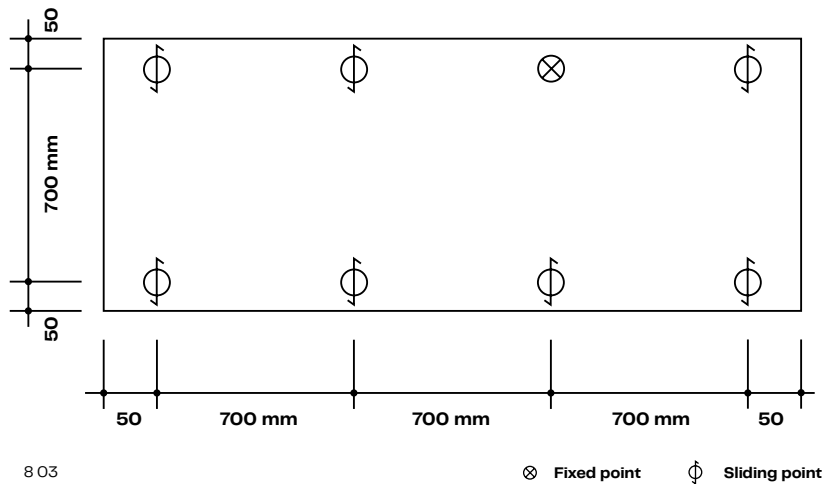

Recommended anchors for fastening to drywalls

Name	Photo	Dimensions	Load capacity	Application
HHD-S hollow wall expansion anchor		e.g., M6 x 38	Shear load: 30 kg	Standard anchor for 95% of the fastenings
HTB-S hollow wall butterfly anchor		e.g., M6 x 60	Shear load: 30 kg	Especially for undefined wall thicknesses
HSP-S self-drilling drywall anchor		e.g., M6 x 38	Shear load: 7 kg	Especially for special or corner solutions

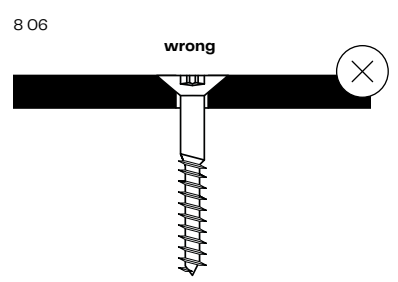
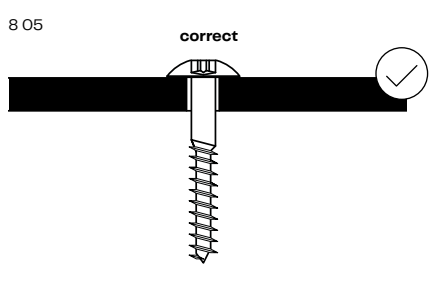
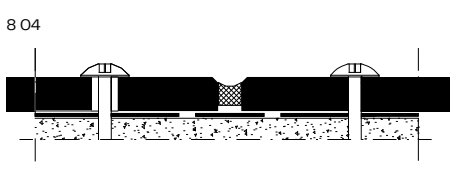

Floor connection variants

In order to be able to form an exact alignment of the edges, it is recommended to use an end profile.

This type of wall cladding is mainly used in areas with increased hygiene requirements, therefore please make sure to create precise joints.

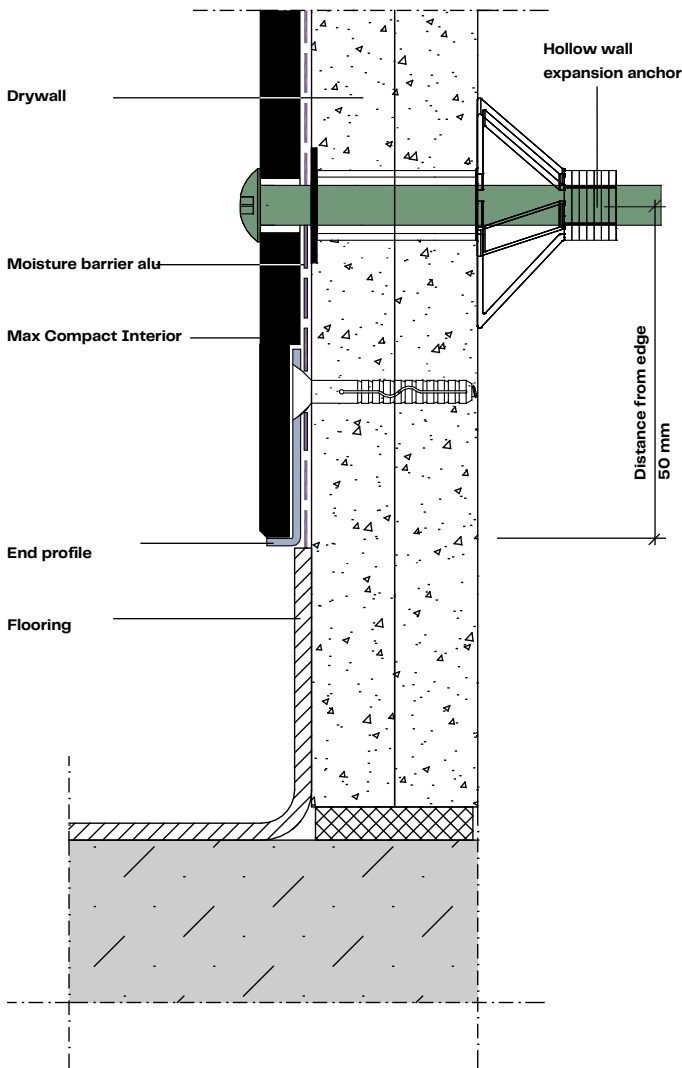

8 07

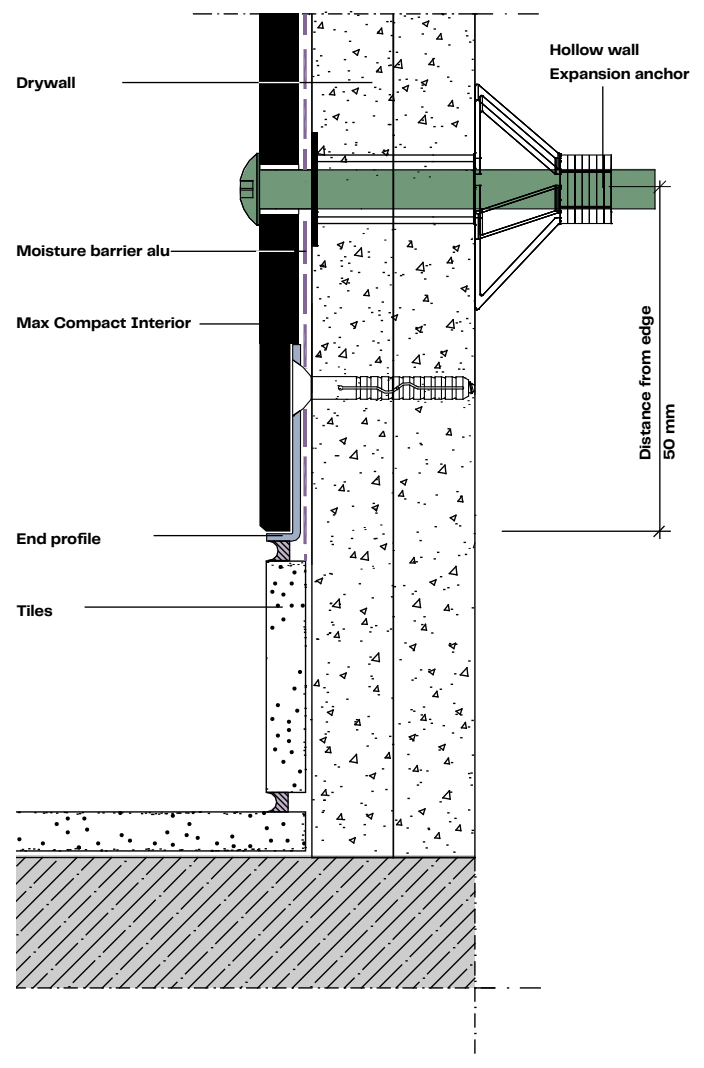

8 08

- 8 03 Single span panel
- 8 04 Example vertical joint
- 8 05 Semi-circular head screw
- 8 06 Countersunk screw
- 8 07 Vertical section impact protection – floor connection with PVC flooring
- 8 08 Vertical section impact protection – floor connection flush with tiles

Side connection details

In order to ensure an exact edge, an end profile should be used.

This type of wall cladding is mainly used in areas with increased hygiene requirements, therefore please make sure to create precise joints.

The butt joint to the door frame or end profile must be at least 5 mm.

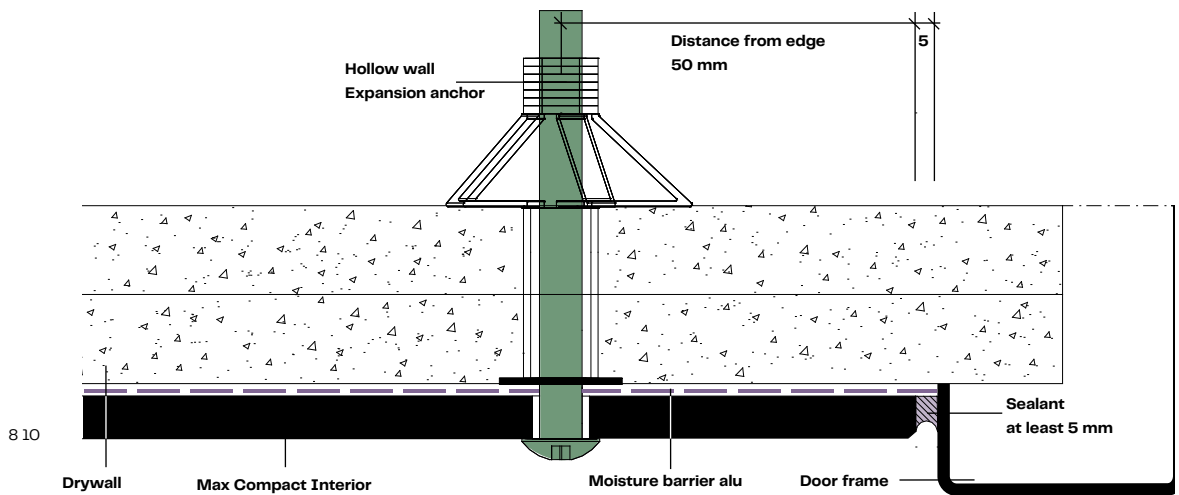
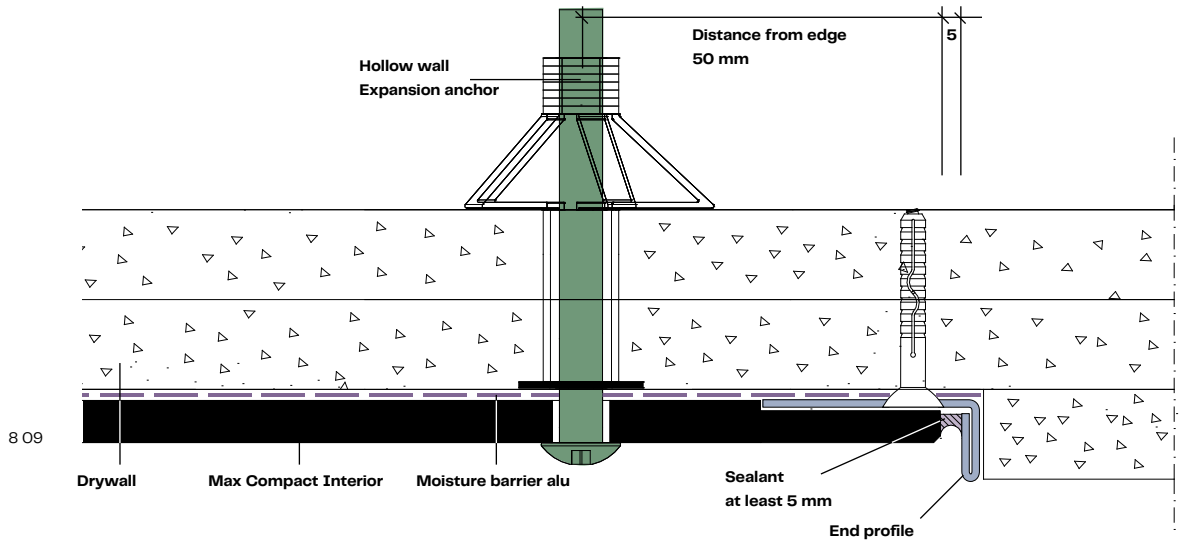

Miter corner formation

In order to ensure an exact edge, an end profile should be used.

This type of wall cladding is mainly used in areas with increased hygiene requirements, therefore please make sure to create precise joints.

Only one row of centrally placed screws can be used for panel strips of up to 100 mm in corner areas.

- 8 09 Horizontal section impact protection – side edge to wall
- 8 10 Horizontal section impact protection – side edge to door frame
- 8 11 Horizontal section corner formation – chamfered joint for inner and outer corners

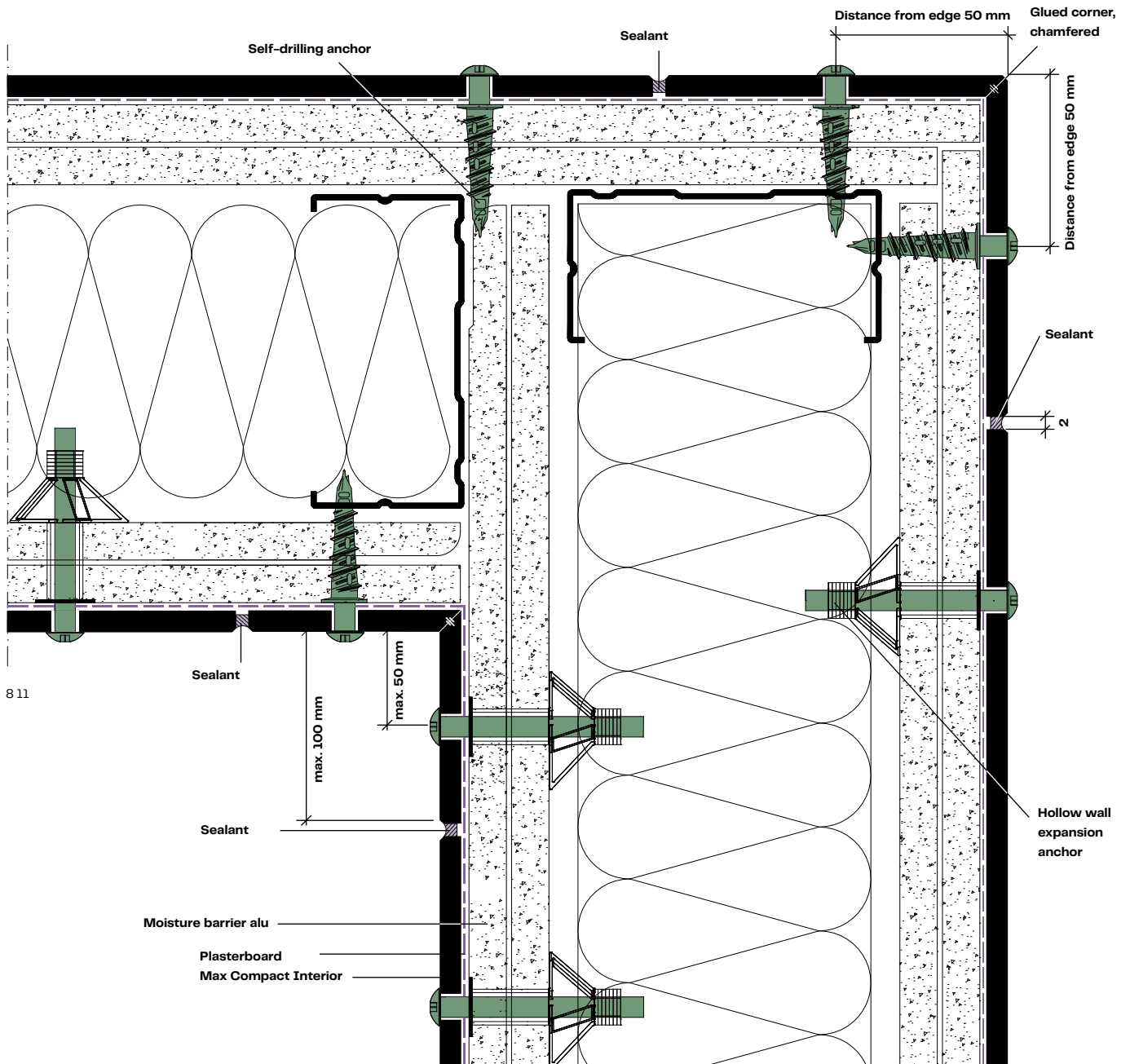

Floor connection variants

In order to ensure an exact edge, an end profile should be used.

This type of wall cladding is mainly used in areas with increased hygiene requirements, therefore please make sure to create precise joints.

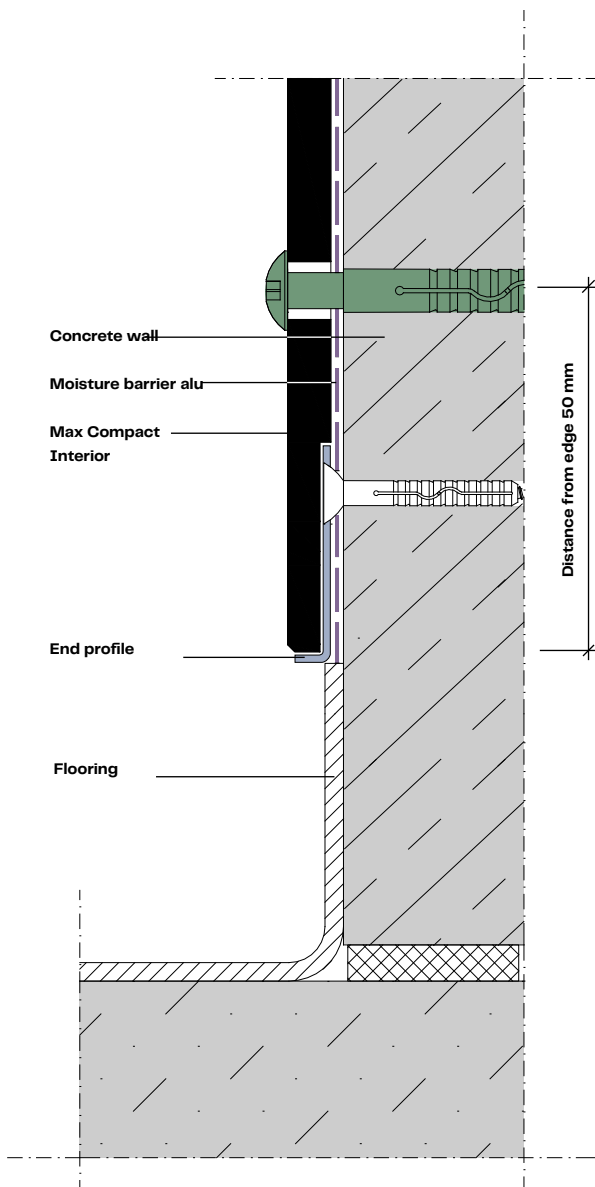

812

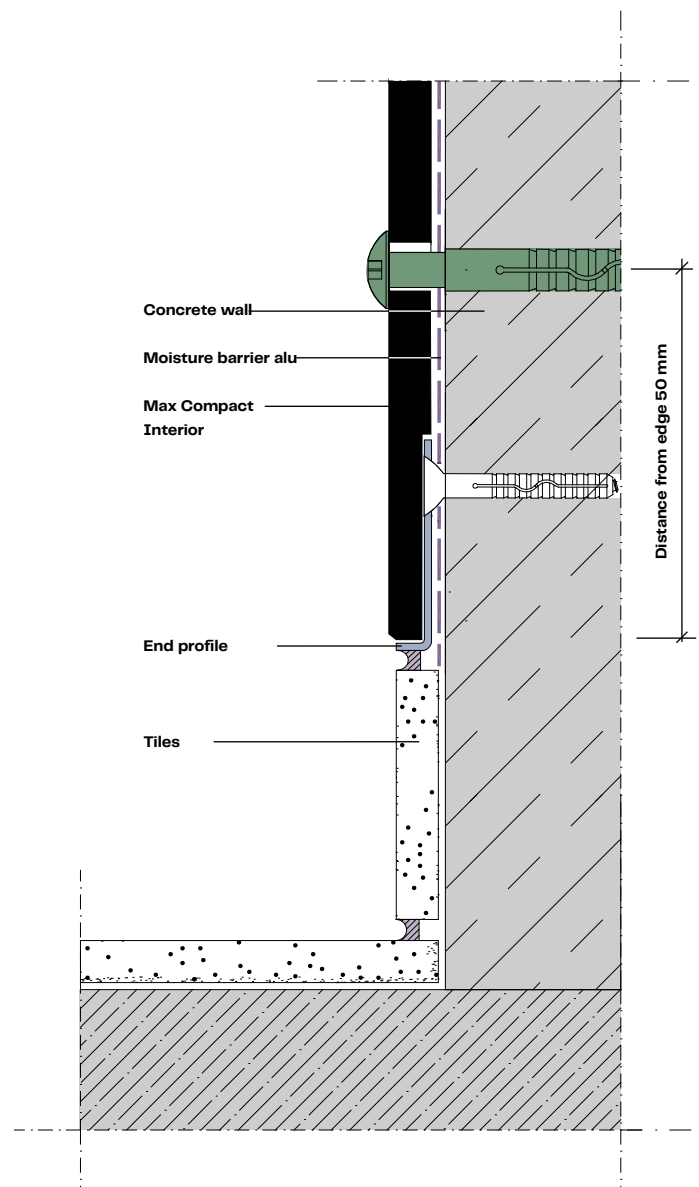

813

Side connection details

In order to ensure an exact edge, an end profile should be used.

This type of wall cladding is mainly used in areas with increased hygiene requirements, therefore please make sure to create precise joints.

The butt joint to the door frame or end profile must be at least 5 mm.

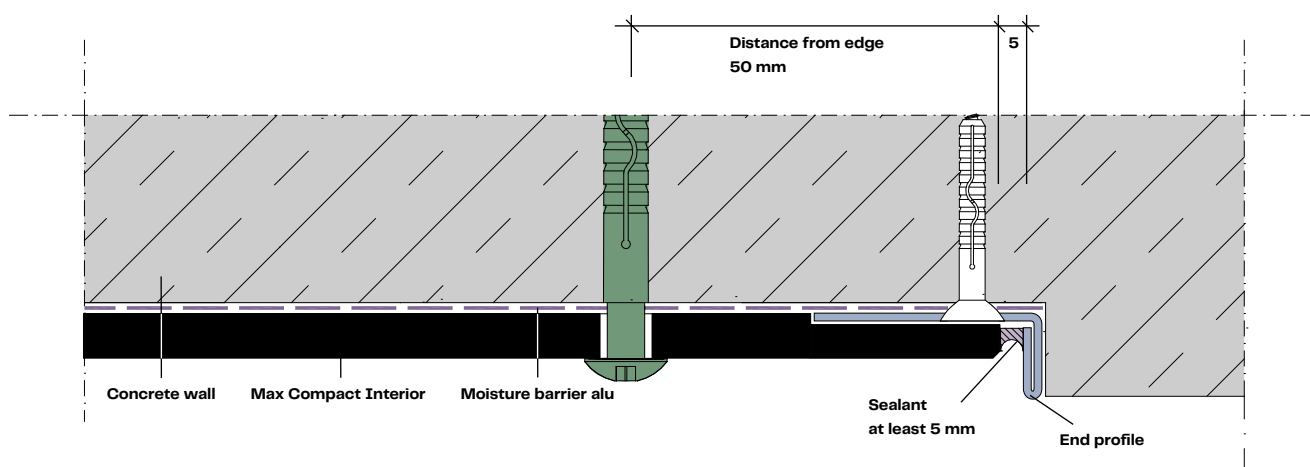

8 14

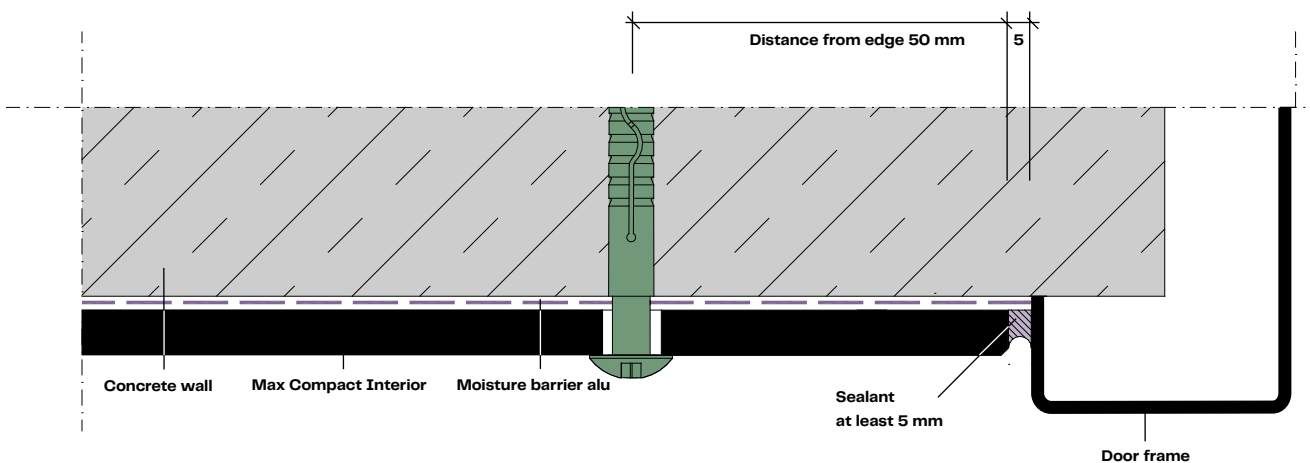

8 15

- 8 12 Vertical section impact protection – floor connection with PVC flooring
- 8 13 Vertical section impact protection – floor connection flush with tiles
- 8 14 Horizontal section impact protection – ending at brickwork
- 8 15 Horizontal section impact protection – ending at brickwork

Miter corner formation

It is absolutely necessary to observe the distance of 50 mm from the edge in order to ensure stability and flatness. In order to accommodate dimensional changes, the joints between the panels must be ≥ 2 mm.

In the corner area, for panel strips up to 100 mm, only one row of centrally placed screws can be used.

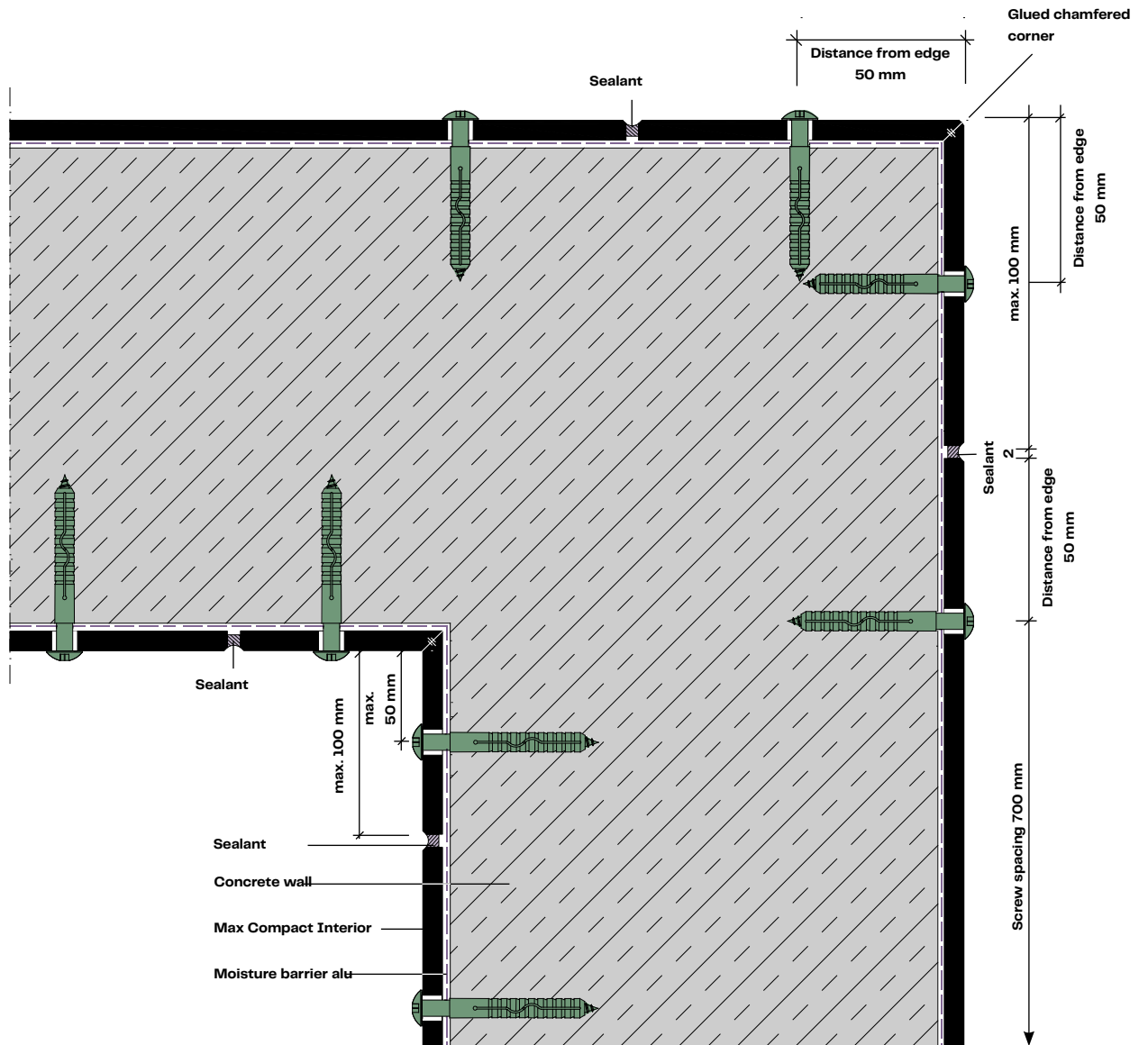

8 16

Suppliers/accessories for wall cladding

Fasteners (mechanical)

Austria

EJOT AUSTRIA GmbH
Graz suburb 146
A-8570 Voitsberg
Tel: +43 (0)3142 27600-0
Fax: +43 (0)3142 27600-30
info@ejot.at
www.ejot.at

SFS Intec GmbH
Wiener Straße 29
A-2100 Korneuburg
Tel: +43 (0)2262 90500-102
Fax: +43 (0)2262 90500-930
www.sfsintec.biz

Hilti Austria GmbH
Altmannsdorferstraße 165
A-1230 Vienna
Tel: +43 (0)800 81 8100
Fax: +43 (0)800 20 1990
hiltiaustria@hilti.com
www.hilti.at

Fischer Austria GmbH
Wiener Straße 95
A-2514 Traiskirchen
Tel: +43 (0)2252 53730-0
Fax: +43 (0)2252 53730-70
www.fischer.at

Germany

MBE GmbH
Siemensstraße 1
D-58706 Menden
Tel: +49 (0)2373 17430-0
Fax: +49 (0)2373 17430-11
www.mbe-gmbh.de

Fischerwerke – Arthur Fischer GmbH
& Co. KG
Weinhalde 14-18
D-72178 Waldachtal
Tel: +49 (0)7443 120
Fax: +49 (0)7443 1242 22
www.fischer.de

Netherlands

Ipex Europe B. V.
Vonderweg 14
NL-7468 DC ENTER
Tel: +31 (0)547 384635
Fax: +31 (0)547 384637
www.ipex-group.com

Switzerland

SFS intec AG (Headquarters)
Rosenbergsaustasse 10
CH-9435 Heerbrugg
Tel: +41 (0)71 727 5151
Fax: +41 (0)71 727 5307
gmi.heerbrugg@sfsintec.biz
www.sfsintec.biz

Profiles/Accessories

Austria

Protektor Bauprofile GmbH
Hirschstettner Straße 19
Component IS/Zi. 318
A-1220 Vienna
Tel: +43 (0)1 259 4500-0
Fax: +43 (0)1 259 4500-19
www.protektor.com/at/

Helmut Lohr Company
Elisabethstraße 36
A-2380 Perchtoldsdorf
Tel: +43 (0)699 11506880
Fax: +43 (0)1 867 4829
info@lohrshop.com

Germany

Protector plant
Florenz Maisch GmbH & Co. KG
Viktoriastraße 58
D-72571 Gaggenau
Tel: +49 (0)7225 977-0
Fax: +49 (0)7225 977-111
info@protektor.com
www.protektor.com

France

PROTECTOR S.A. BATI PROFILE
Rue Pasteur Prolongée
F-94400 Vitry sur Seine
Tel: +33 (0)1 55 531750
Fax: +33 (0)1 55 531740

Touch-up markers (varnish)

Austria

VOTTELER Lacktechnik GmbH
Malvenstraße 7
A-4600 Wels
Tel: +43 (0)7242 759-0
Fax: +43 (0)7242 759-113
at.info@votteler.com
www.votteler.com

Germany

Heinrich König & Co. KG
An der Rosenhelle 5
D-61138 Niederdorfelden
Tel: +49 (0)6101 5360-0
Fax: +49 (0)6101 5360-11
info@heinrich-koenig.de
www.heinrich-koenig.de

FSG Schäfer GmbH
Boschstraße 14
D-48703 Stadtlohn
Tel: +49 (0)2563 9395-0
Fax: +49 (0)2563 9395-25
verkauf@fsg-schaefer.de
www.fsg-schaefer.de

Type C: non-ventilated wall panelling bonded

Mounting Fundermax Compact panels on drywall, concrete or brick wall

As hygiene requirements for special buildings, such as hospitals, are constantly increasing, it is sometimes necessary to install the wall protection directly without rear ventilation.

Under certain conditions, Fundermax HPL panels can be bonded directly to drywall, concrete or brick walls.

Product names

- Max Compact Interior
- Max Compact Interior F-Quality

Product features:

- scratch resistant
- impact-resistant
- solvent resistant
- easy to clean

Building material class:

- Max Compact Interior: EN 13501-1 D-s2,d0
- Max Compact Interior F-Quality: EN 13501-1 B-s1,d0

Requirements

PLEASE NOTE: To ensure that the wall protection is secure and flat, the following points must be observed:

- A strip-shaped substructure with a minimum thickness of 3 mm must be selected
- Substructure clearances must be observed
- Countersink the screw heads into the substructure so as not to affect the adhesive system – nevertheless ensure sufficient residual thickness
- Full-surface aluminium vapour barrier between wall and substructure
- Use a permanently elastic adhesive system (obtain information from the adhesive manufacturer)
- Condition the boards to the room climate
- Panel joints to lateral end profiles or door frames must be at least 5.0 mm
- In general, the joints at the panel joints should be ≥ 2.0 mm.
- Dry wall (own responsibility measurement, component moisture 0.4 % to max. 1 %)

Mounting

For a neat corner finish, start the panel installation at the outer corners. Then mount individual grids or adjustment panels. Fasten them with adhesive according to the processing instructions of the adhesive manufacturer.

Here are some manufacturers of popular adhesives with German building authority approval:

- SIKA
- INNOTEK
- PROPART
- MBE

Mounting distances for 6 mm Compact:

Grid dimension: 500 mm

Mounting distances for 8 mm Compact:

Grid dimension: 600 mm

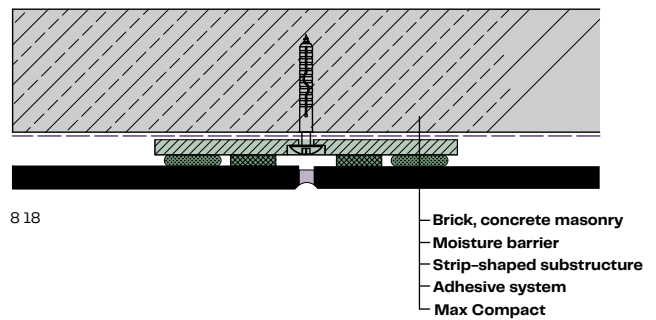
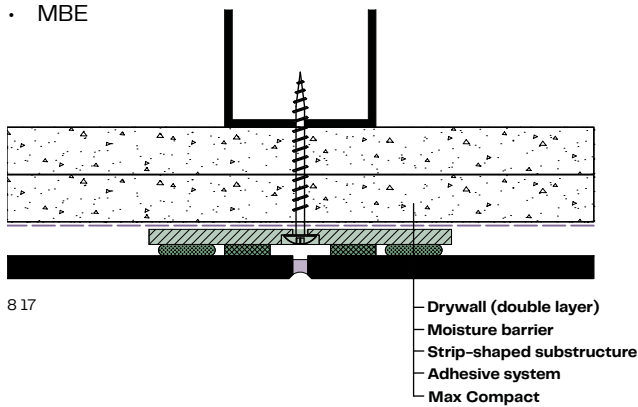

Fastening the substructure

For the substructure, it is best to use panel strips made of Compact or thin aluminum strips with a thickness of at least ≥ 3 mm each. The strip-shaped substructure serves to create an optimal subsurface for bonding. It can also be used to even out small irregularities in the wall.

IMPORTANT: Countersink the screw head into the substructure so that it does not protrude and interfere with the bonding system.

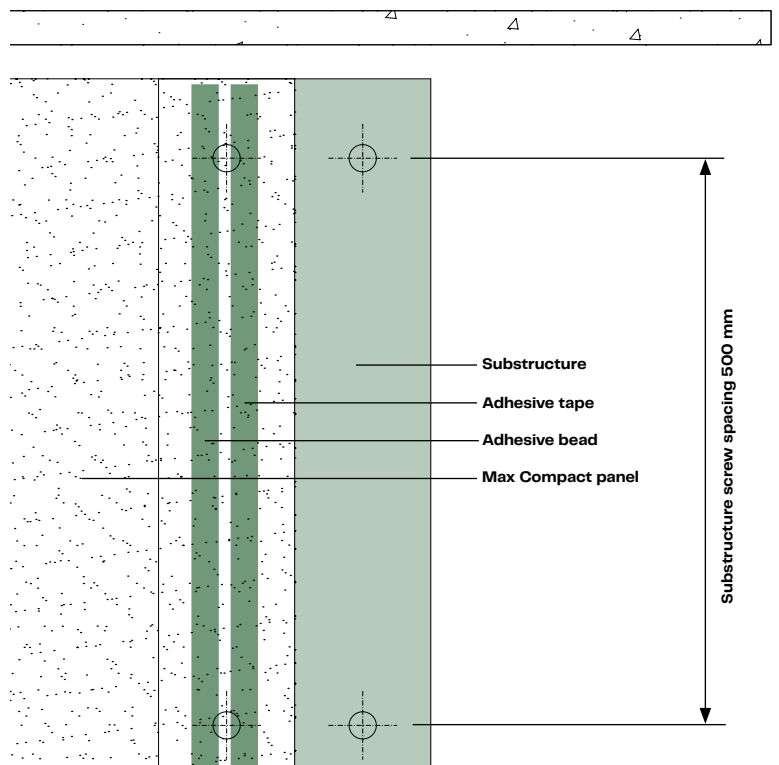

817 Plasterboard connection/horizontal section wall protection

818 Brick wall/horizontal section wall protection

819 Substructure/adhesive

819

Drywall details

Floor or ceiling connection types

This type of wall cladding is used mainly in areas with increased hygiene requirements, therefore please make sure the joints are processed precisely.

If required, also connection or end profiles can be used to make clean component connections.

- 8 20** Floor connection/vertical section wall protection
- 8 21** Ceiling connection/vertical section wall protection
- 8 22** Floor connection/vertical section wall protection

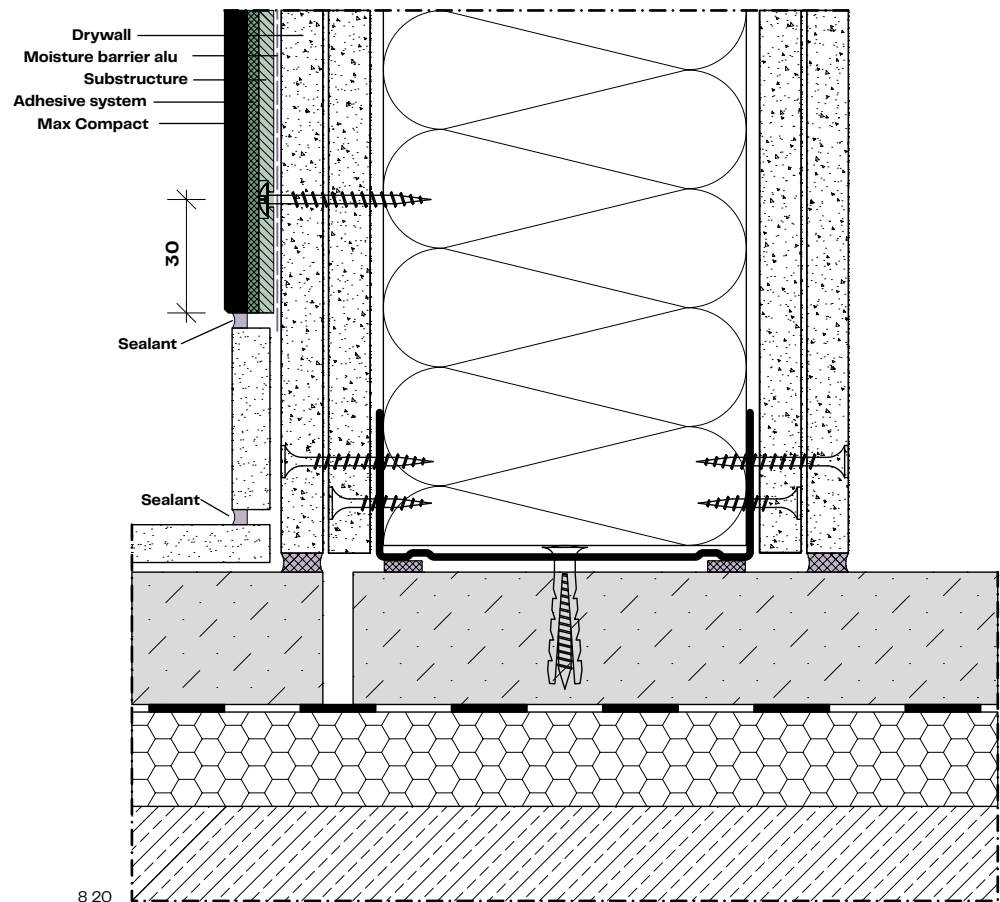

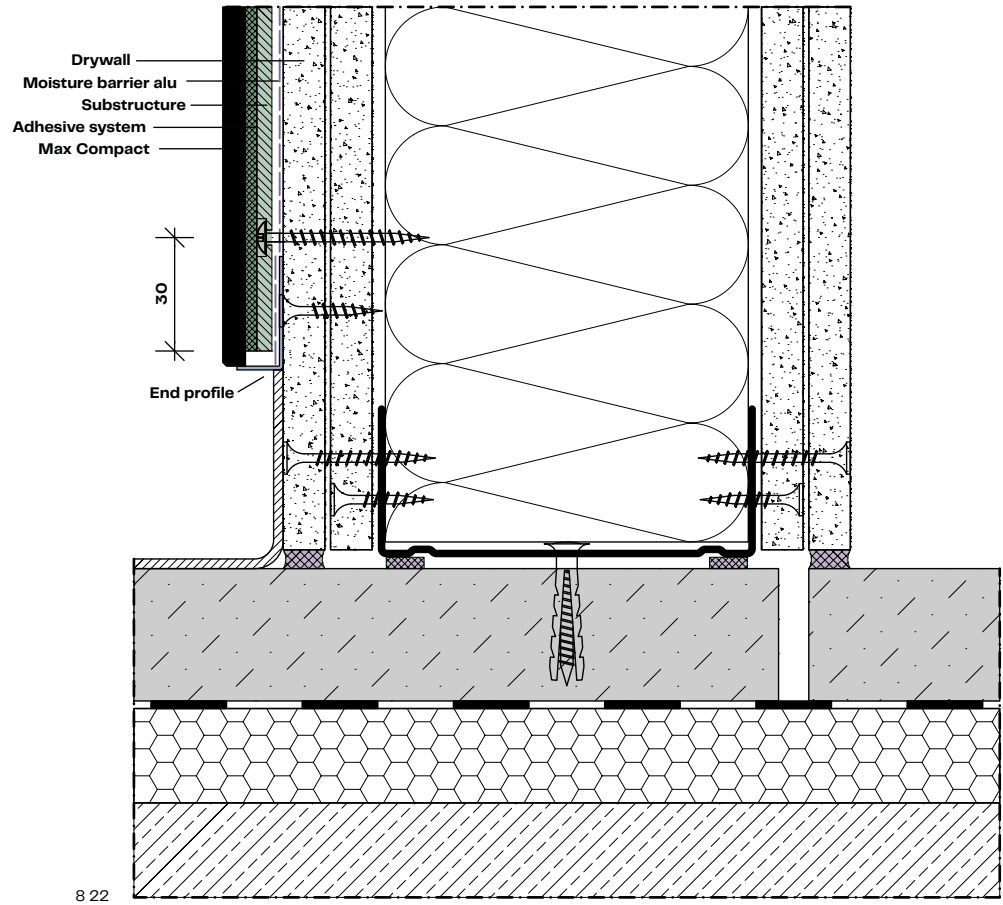
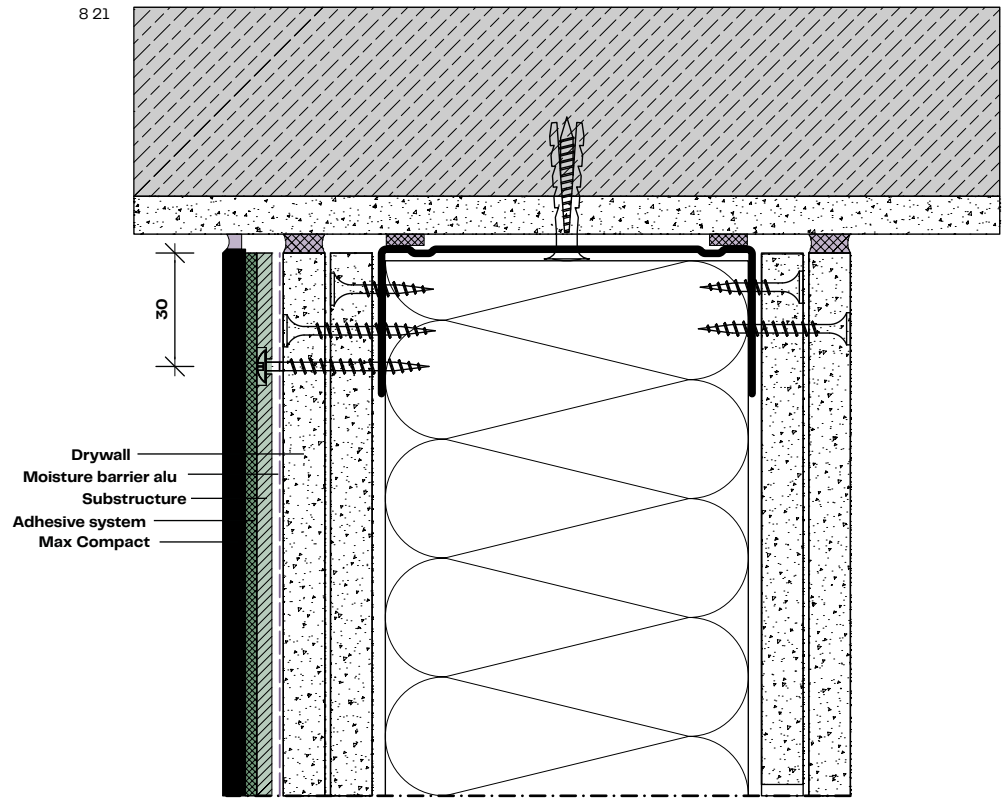

Side connection details

For exact connection: Use the connection profile.

This type of wall cladding is used mainly in areas with increased hygiene requirements, therefore please make sure the joints are processed precisely.

The butt joint to the door frame or end profile must be at least 5 mm.

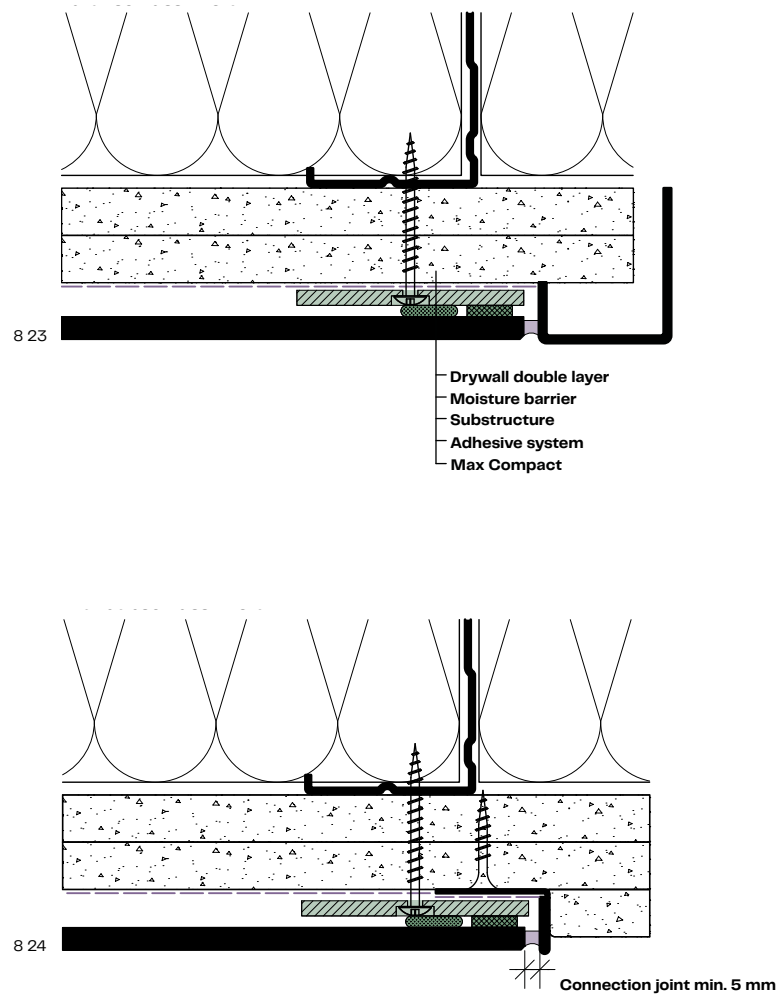

Miter corner formation

To accommodate dimensional change: Make joints between panels ≥ 2 mm!

In the corner area, for panel strips up to 100 mm, only one adhesive bead can be set.

- 8 23 Horizontal section door connection
- 8 24 Horizontal section wall connection
- 8 25 Outside corner/horizontal section

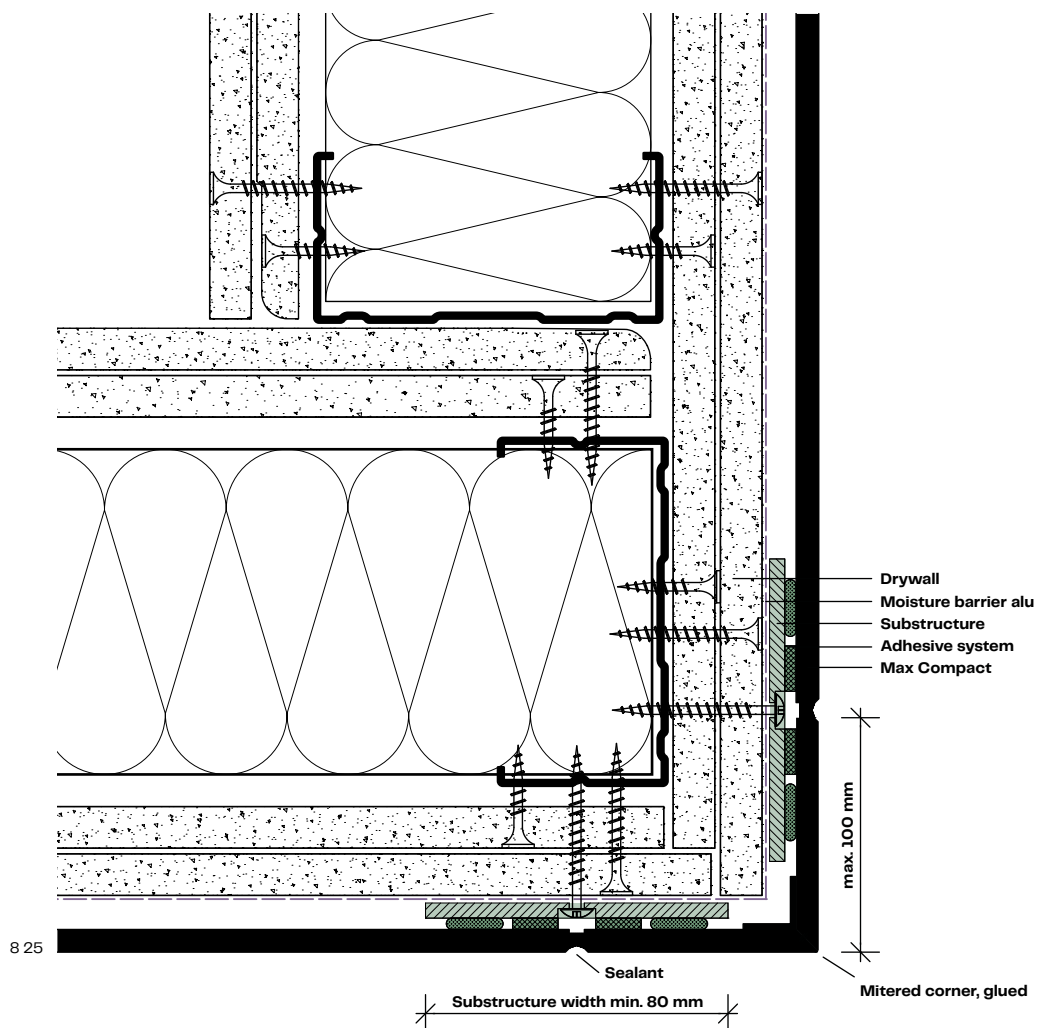

Details for concrete or brick walls

Floor connection variants

This type of wall cladding is used mainly in areas with increased hygiene requirements, therefore please make sure the joints are processed precisely.

If required, also connection or end profiles can be used to make clean component connections.

- 8 26** Floor connection concrete or brickwork/vertical section
- 8 27** Ceiling connection concrete or brickwork/vertical section
- 8 28** Floor connection concrete or brickwork/vertical section

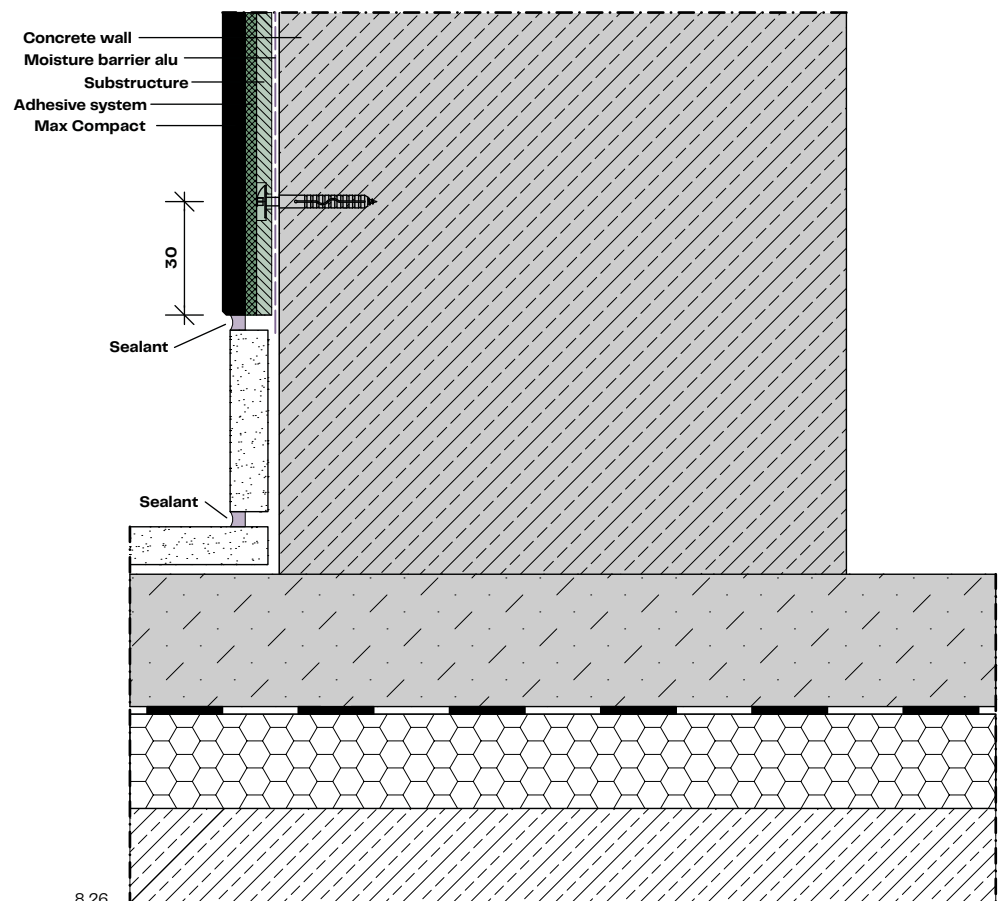

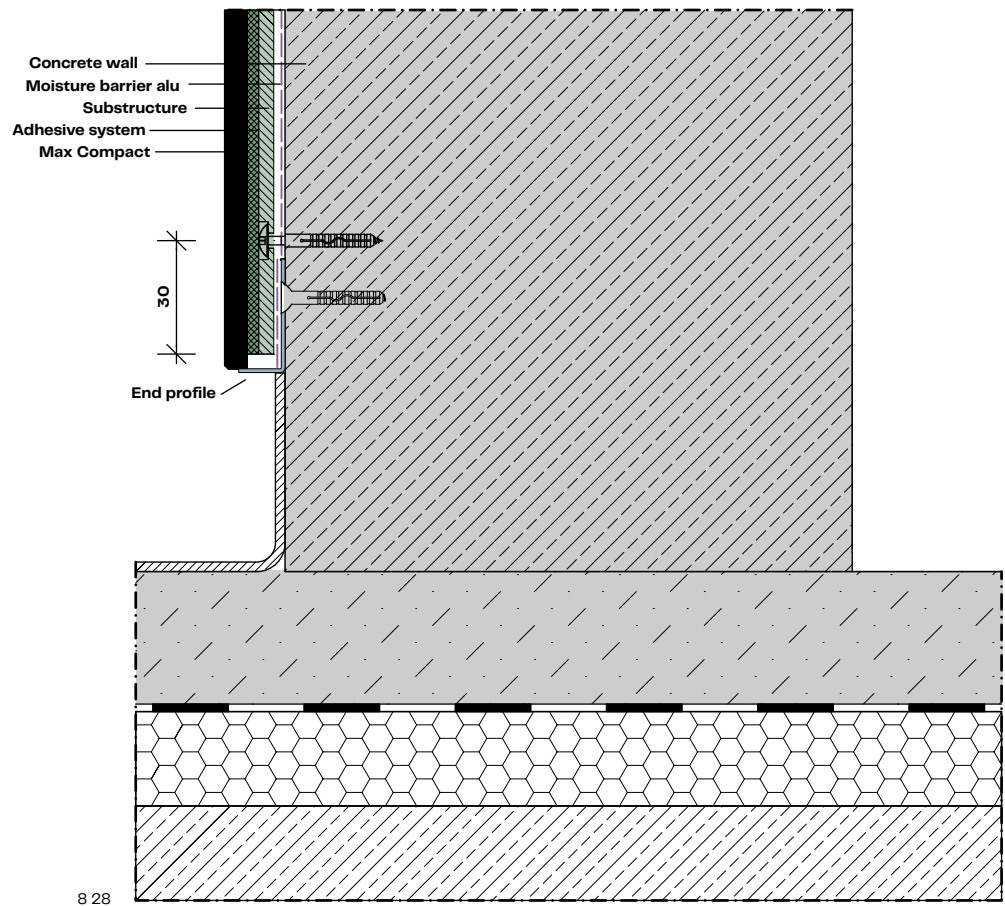
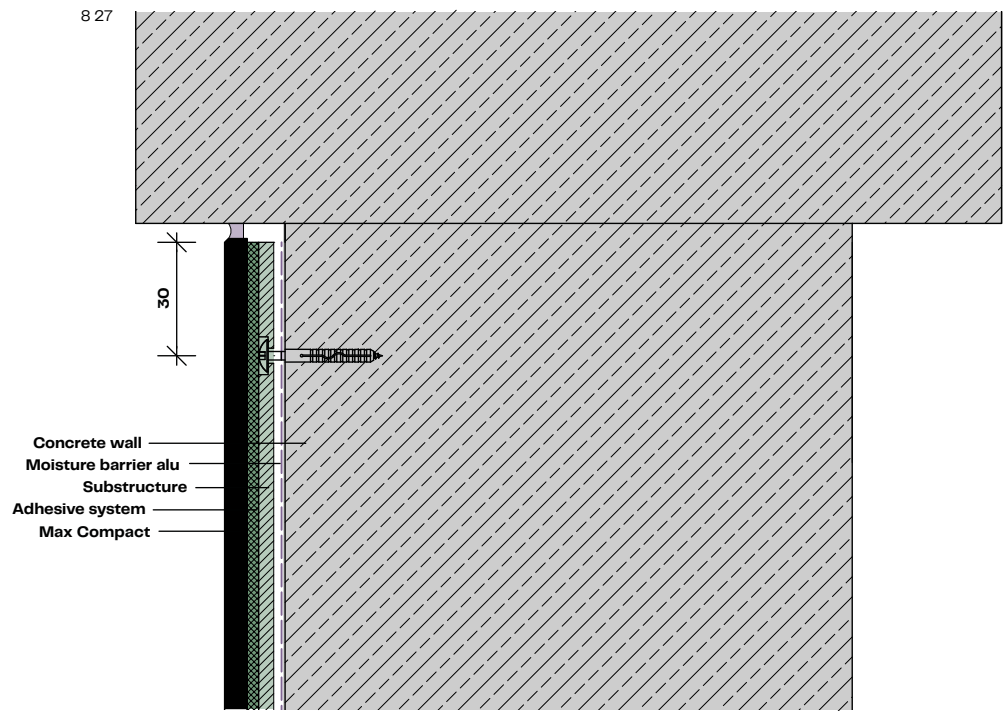

Side connection details

For exact connection: Use the connection profile.

This type of wall cladding is used mainly in areas with increased hygiene requirements, therefore please make sure the joints are processed precisely.

The butt joint to the door frame or end profile must be at least 5 mm.

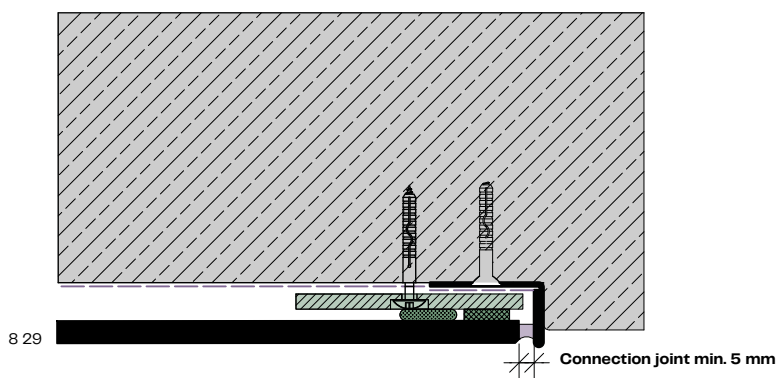

Miter corner formation

To accommodate dimensional change: Make joints between panels ≥ 2 mm!

In the corner area, for panel strips up to 100 mm, only one adhesive bead can be set.

- 8 29** Concrete/brick wall Wall/door connection/horizontal section
8 30 Concrete/brick wall Outside corner/horizontal section

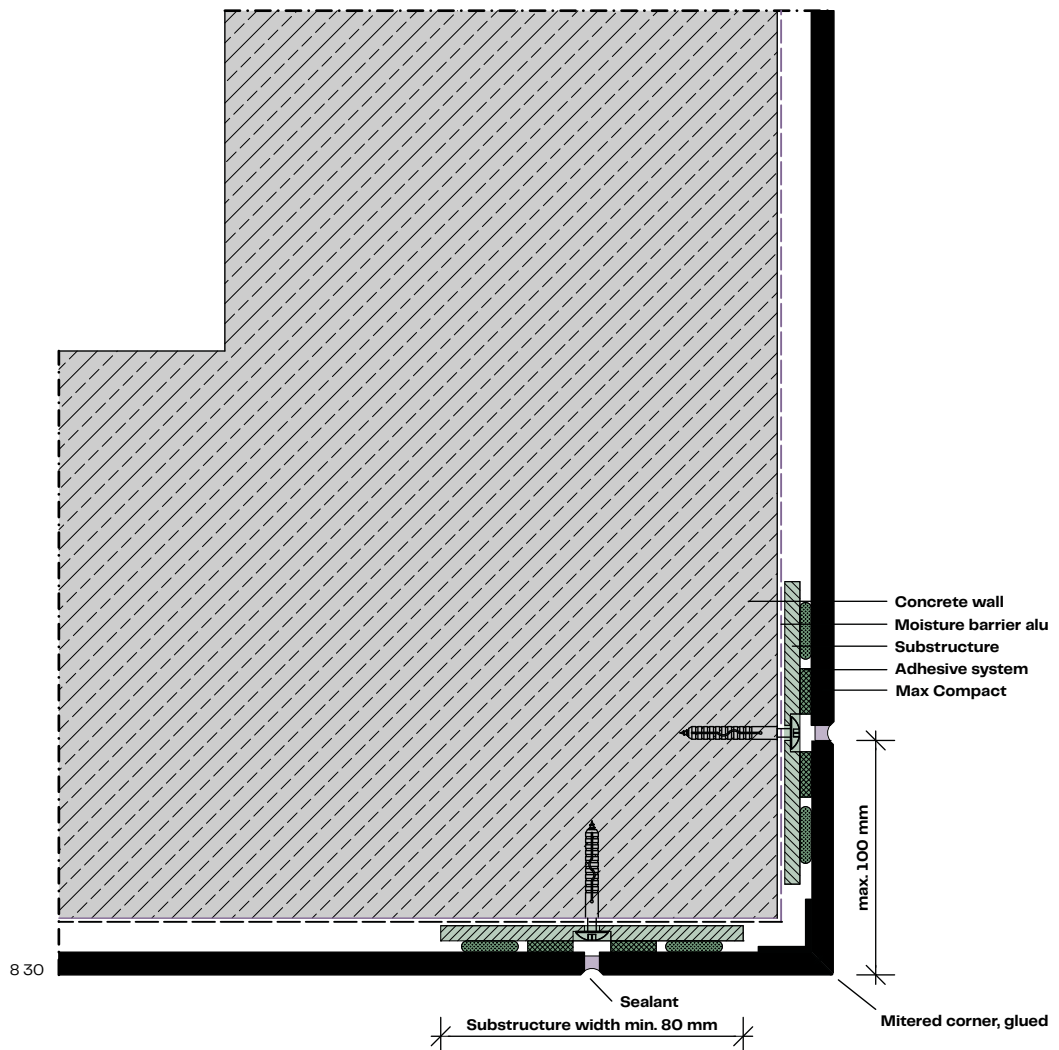



8 31 Wall cladding directly glued
8 32 Wall cladding directly glued

Suppliers/accessories for directly glued wall protection

Fasteners (mechanical)

Austria

INNOTEK Industries
Vertriebsgesellschaft mbH
Floor 35
A-6322 Kirchbichl
Tel.: +43 (0)5332 71138
Tel.: +43 (0)5332 72891
www.innotec.at

PROPART Handels GmbH
Lauchenholz 28
A-9122 St. Primus
Tel.: +43 (0)4239 40300
Fax: +43 (0)4239 40300-20
www.fassaden-kleben.at

Fassadenklebetechnik Klug GmbH
(SIKA)
Julius-Tandler-Platz 6/15
A-1090 Vienna
Tel.: +43 (0)676 7271724
r.klug@fassadenklebetechnik.at
office@fassadenklebetechnik.at
www.fassadenklebetechnik.at

Germany

MBE GmbH
Siemensstraße 1
D-58706 Menden
Tel.: +49 (0)2373 17430-0
Fax: +49 (0)2373 17430-11
www.mbe-gmbh.de

Profiles/Accessories

Austria

Protektor Bauprofile GmbH
Tel.: +43 (0)1 259 4500-0
Fax: +43 (0)1 259 4500-19
www.protektor.com

Helmut Lohr Company
Elisabethstraße 36
A-2380 Perchtoldsdorf
Tel.: +43 (0)1 8698652
Fax: +43 (0)1 8674829
info@lohrshop.com

Touch-up markers (varnish)

Austria

Votteler Lacktechnik GmbH
Malvenstraße 7
A-4600 Wels
Tel.: +43 (0)7242 759-0
Fax: +43 (0)7242 759-113
at.info@votteler.com
www.votteler.com

Germany

#Heinrich König & Co. KG
An der Rosenhelle 5
D-61138 Niederdorfelden
Tel.: +49 (0)6101 5360-0
Fax: +49 (0)6101 5360-11
info@heinrich-koenig.de
www.heinrich-koenig.de

9 Cubicles



“We want the best for the children – and for our facility.”

(Flora M., Teacher)



Due to their water resistance and hygienic surface, Max Compact Interior panels are suitable for use in wet room areas, as shower walls, for therapy cubicles and changing rooms. For these situations, there is a wide range of colors available from the Fundermax collection.



Technical notes on applications with Max Compact Interior panels

Protect the material from accumulating moisture during construction and installation – the panel material must be allowed to dry with sufficient air circulation in the cubicles. Ensure sufficient ventilation of the rooms.

When connecting Max Compact Interior panels with each other, make sure that the grain direction is the same (vertical with vertical and horizontal with horizontal). Leftover panel pieces should always be marked with the production direction. Support corner joints with anchors, springs, special milling, etc.

Construction of shower stalls: Do not expose Max Compact Interior door elements to direct water contact. To keep the door from warping, shower stalls should have an anteroom (e.g., shower cubicle with changing area and curtain as separation).

In case of heavy wetness: use mechanical corner connection and elastic, waterproof setting adhesive system!

Note:

Observe valid product portfolio. The construction elements described in this brochure are suitable for all areas of use of Max Compact Interior panels. Other profiles, screws, etc.: Only use those of stainless steel, brass or aluminum quality!

Fundermax reserves the right to make changes in the interest of technical progress.

- 9 01** Cubicles with shield on the front side
- 9 02** Cabin with separating wall supports
- 9 03** Cabin with separating wall supports, top view
- 9 04** shield on the front shield reaching to the ground
- 9 05** shield on the front side reaching to the ground, top view

Construction examples for changing rooms and restroom cubicles

Cabin doors

A maximum door width of 900 mm must not be exceeded. For larger widths, a frame must be installed to support the door.

The construction examples on the following pages merely show a few possibilities for cubicle construction. Requirements may vary depending on construction and fittings. Recommended panel thickness: 13 mm.

The following mounting distances apply for door hinge distances as well as the mechanical attachment of the Max Compact Interior panel to the wall and the Max Compact Interior panels to each other:

Panel thickness in mm	max A in mm	E in mm
13.0	600.0	20 – 100

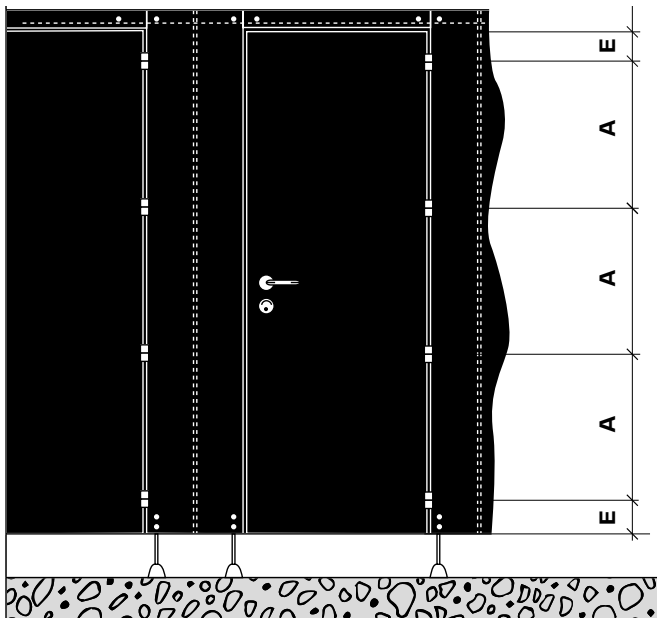

9 02

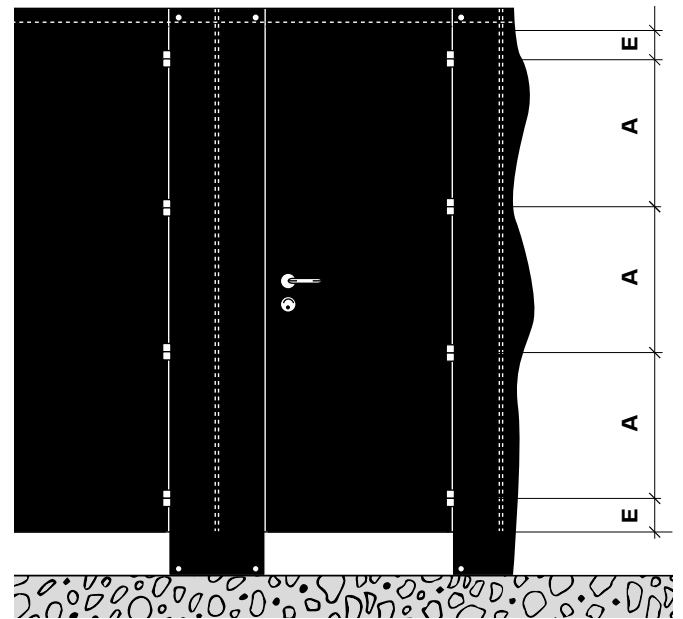

9 05

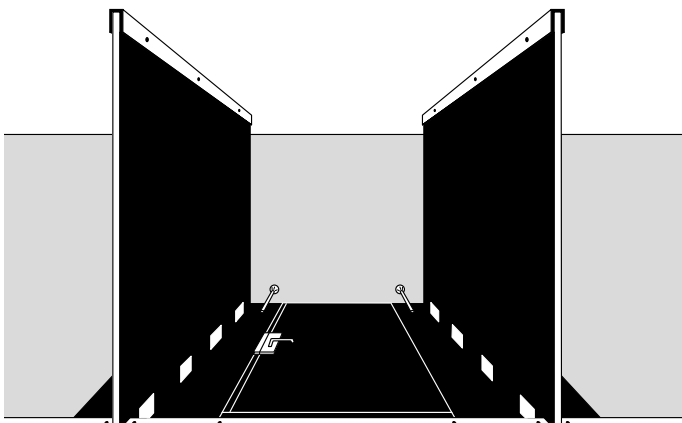

9 03

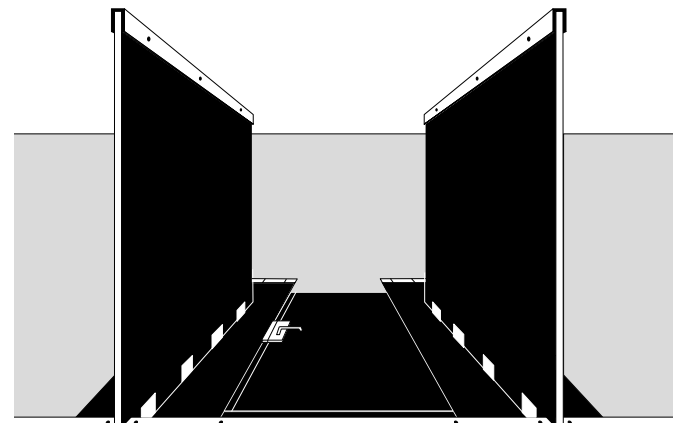

9 04

Construction Examples for Changing Rooms and Restroom Stalls

Construction Example Shower Divider

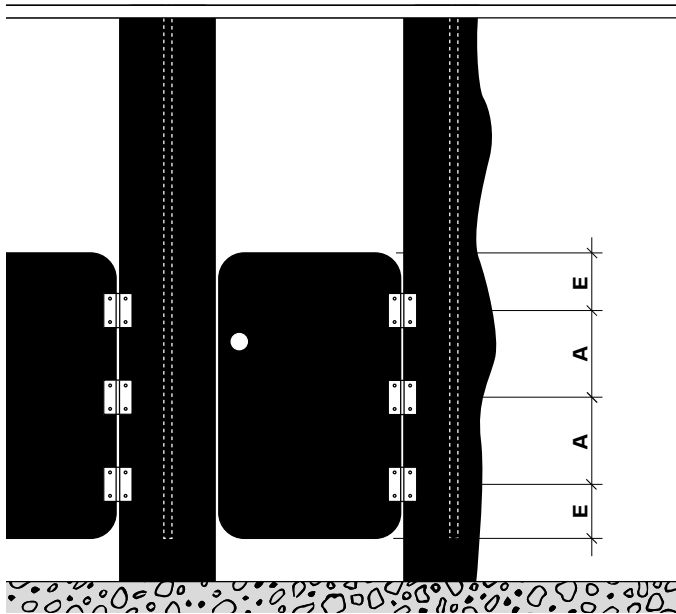

9 06

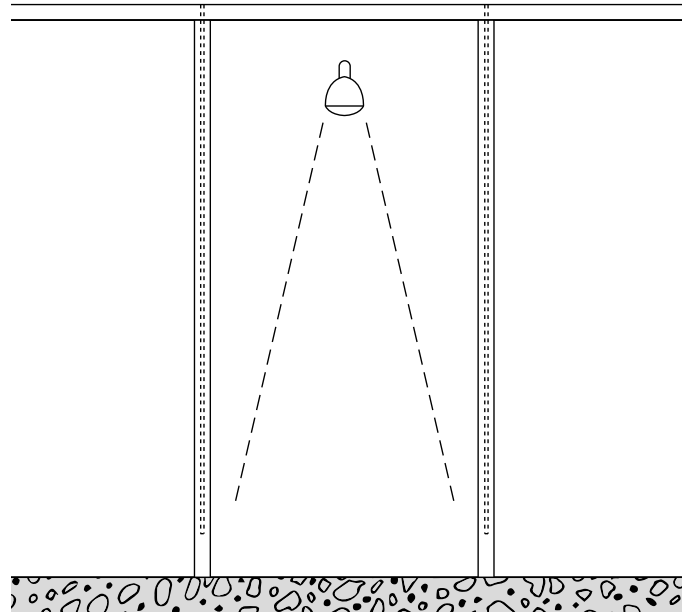

9 08

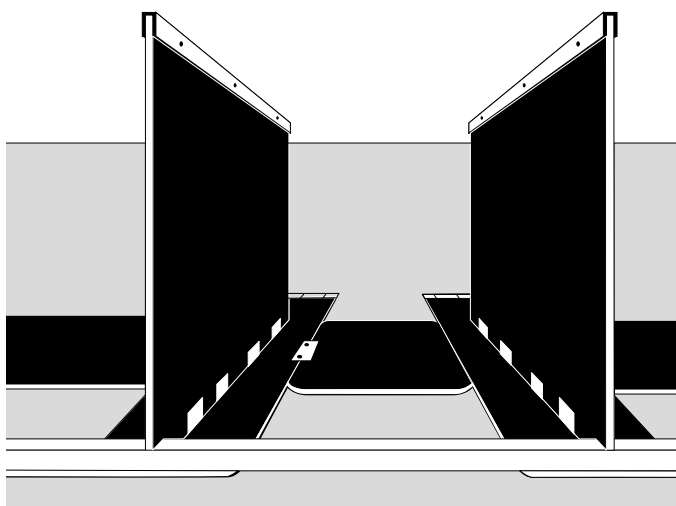

9 07

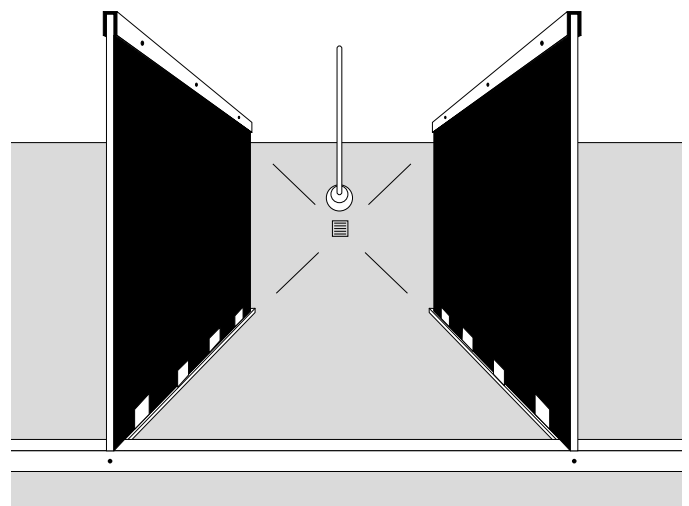

9 09

- 9 06 Cubicles with closing doors (spring hinges) for nursery school showers or changing rooms
- 9 07 Cubicles with closing doors, top view
- 9 08 Shower divider with uprights and lintel profile made from forming tube
- 9 09 Shower divider with uprights and lintel profile made from forming tube, top view

Construction details

Floor connections

In order to balance out uneven ground surfaces, but also to protect the Max Compact Interior panels from a build-up of water, foot supports from various suppliers are used (see suppliers/ accessories for cubicles p. 89).

Wall separating supports:

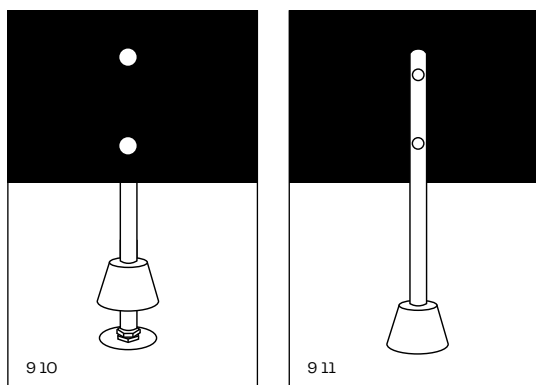

Wall separating supports with in-built height adjustment:

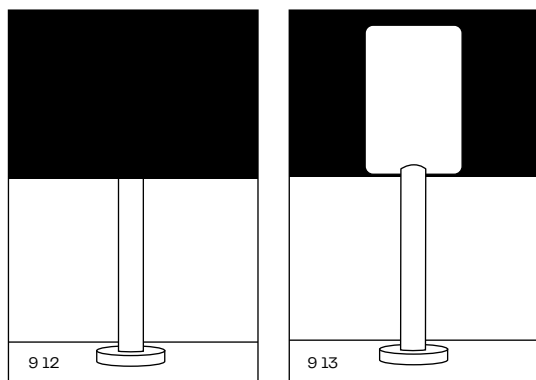

L-profile natural anodized aluminum:

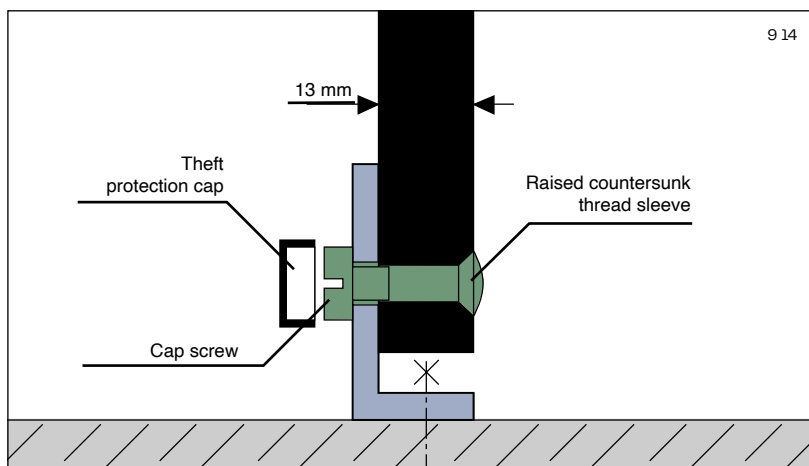

Floor connection for frontal uprights (for shower and screen walls) and cubicles:

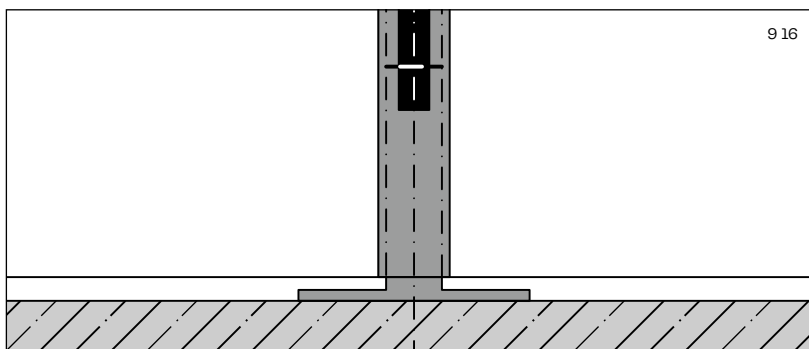

- 9 10 Supports with height adjustment, exterior view
- 9 11 Supports with height adjustment, interior view
- 9 12 Height-adjustment in-built supports, exterior view
- 9 13 Height-adjustment in-built supports, interior view
- 9 14 Vertical section floor connection with an L-profile
- 9 15 FLOOR CONNECTION WITH L-PROFILE
- 9 16 Vertical section floor connection with forming tube

Connections of separating agents

Wall mounting is usually done with angles made of aluminum, stainless steel or plastic.

Stainless steel wall connecting component with two black end caps:

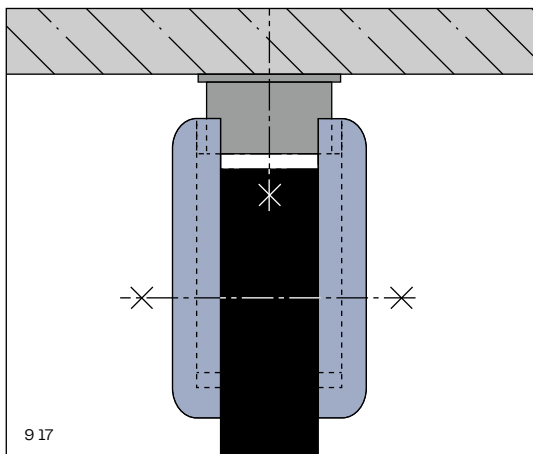

Wall separating connection brackets made from plastic for the connection of the front components, to the outside walls:

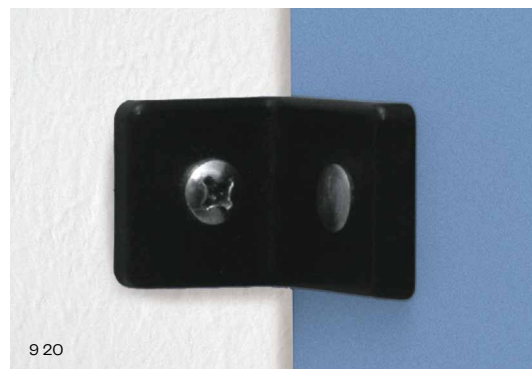
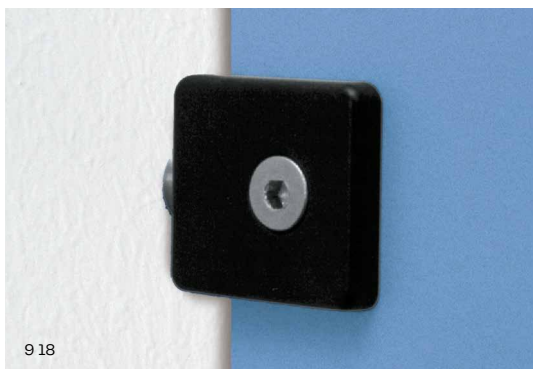
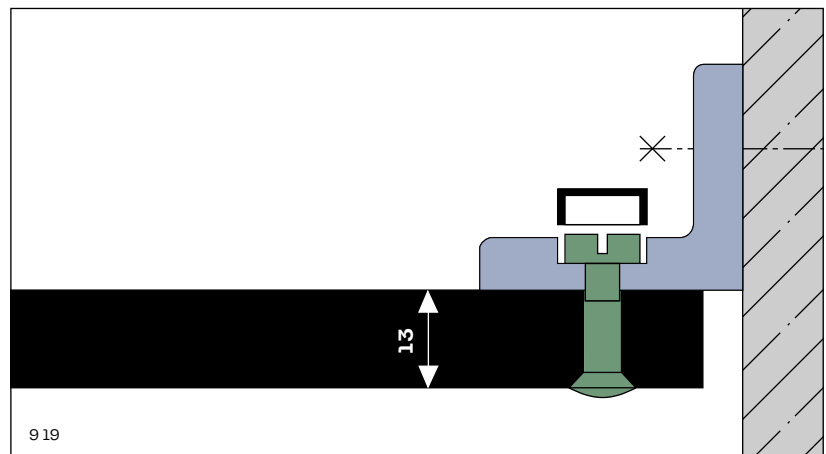

For larger expansion areas (≤ 12 mm), an adjustment is usually unnecessary. Access is, however, not possible.

- 9 17 Stainless steel wall connecting component, horizontal section
 9 18 Stainless steel wall connecting component
 9 19 Wall separating connection brackets made from plastic, horizontal section
 9 20 Wall separating connection brackets made from plastic

Wall connections

U-profile anodized aluminum for a connection of the separating screens to the wall (13 mm Max Compact Interior panels):

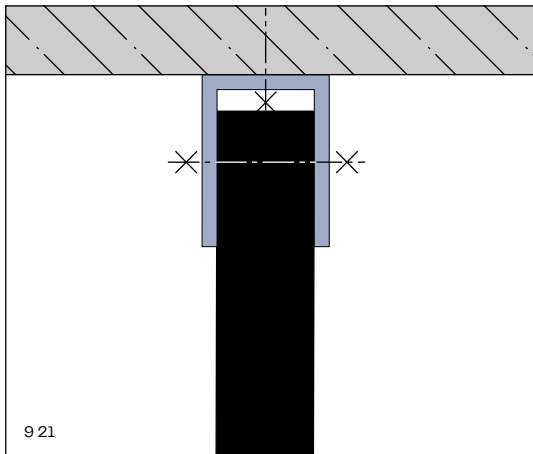

2 wall separating connection brackets made from plastic with 13 mm lights for Max Compact Interior panels:

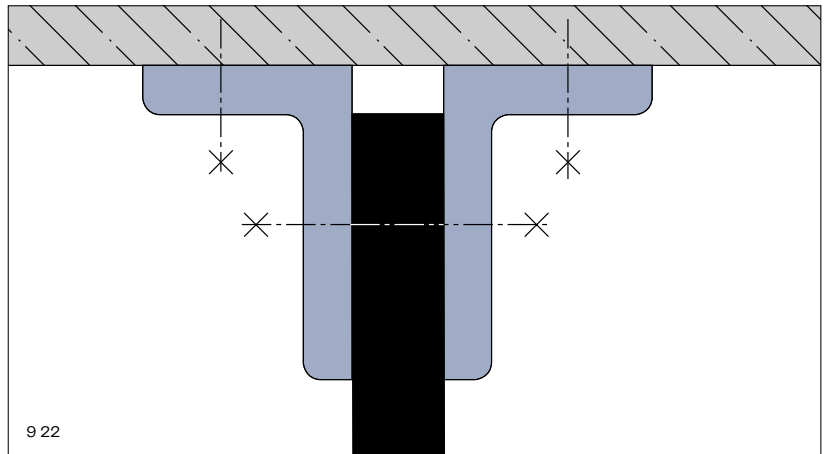

Trax coupling for the connection of the separating walls to the front screens with 2 black cover plates for 13 mm thick panels:

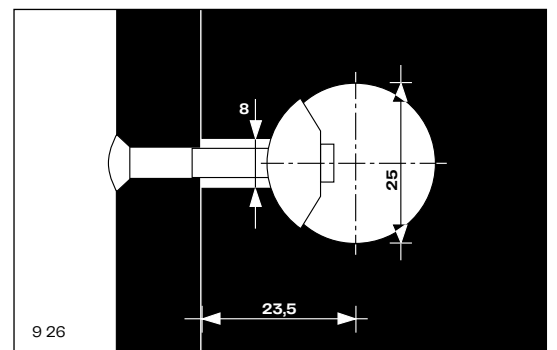
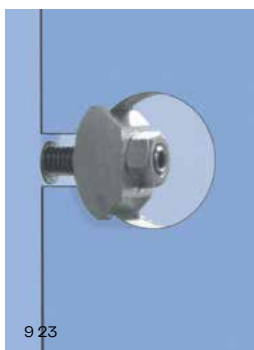

- 9 21 U-profile
- 9 22 2 Wall separating connection brackets made from plastic, horizontal section
- 9 23 Trax coupling open
- 9 24 black cover plate
- 9 25 Connection of the separating wall to the upright frame
- 9 26 Side view of the couple drilling

- 9 27 Vertical section of the lintel profile above
- 9 28 Door hinge
- 9 29 Support area for inwards opening doors a minimum of 80 mm high, in order to be able to hang the door; dimension A
- 9 30 View of milling out for coupling
- 9 31 Straining screw
- 9 32 Panel connectors
- 9 33 Horizontal section Over-panelling

Door support profiles and lintel profiles

Lintel profile:

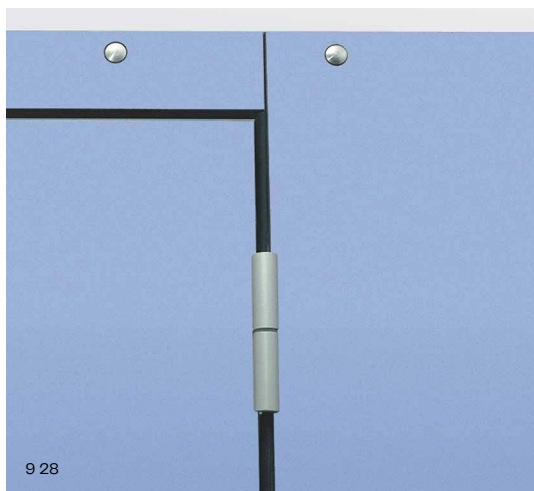
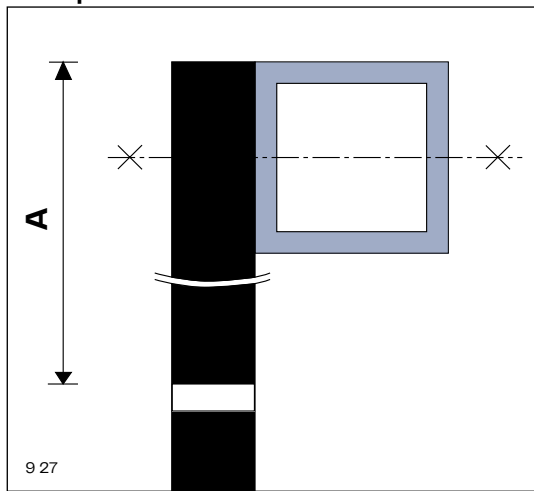

Panel connections

For the connection of Max Compact Interior panels; a separating wall panel thickness: 13 mm

Couplings for panel connections:

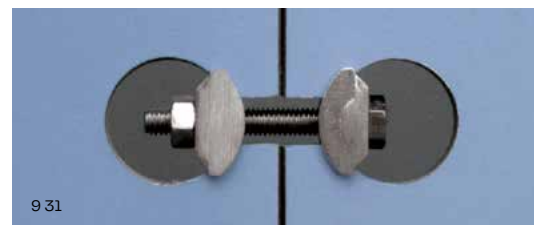
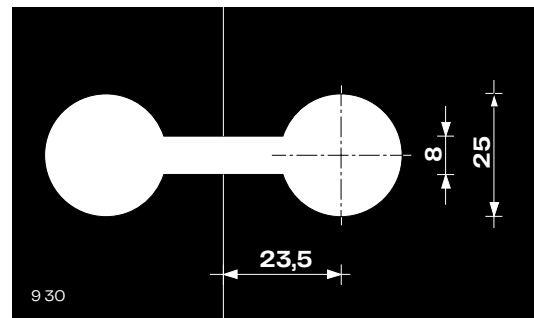

Over-panelling:

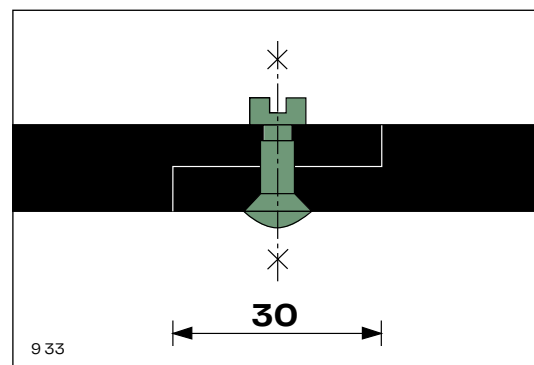

The over-panelling must be at least 30 mm wide. Gluing is done with PUR glue and 3 to 4 screws in addition. For wall wider than 1300 mm, a stiffening profile and a support must be provided.

Suppliers/accessories for cubicles*

Construction elements

Austria

Helmut Lohr Company
Elisabethstraße 36
A-2380 Perchtoldsdorf
Tel: +43 (0)699 11506880
Fax: +43 (0)1 8674829
info@lohrshop.com

Germany

Schäfer Bädertechnik
Moselstraße 61
D-42579 Heiligenhaus
Tel: +49 (0)2054 9384666
Fax: +49 (0)2054 9384667
schaefer@baedertechnik.com
www.baedertechnik.com

Normbau GmbH
Schwarzwaldstraße 15
D-77871 Renchen
Tel: +49 (0)7843 704-0
Fax: +49 (0)7843 704-43
info@normbau.de
www.normbau.de

PBA Deutschland
Raiffeisenstraße 4a
D-83607 Holzkirchen
Tel: +49 (0)8024 6084694
Fax: +49 (0)8024 4749890
info@de.pba.it

Italy

PBA s.r.l.
Via Enrico Fermi 1
I-36056 Tezze Sul Brenta (VI)
Tel: +39 (0)424 5451
Fax: +39 (0)424 545222
info@pba.it
www.pba.it

Fittings

Austria

GM Zargenprofil Topglas –
Glas Marte GmbH & Co. KG
Brachsenweg 39
A-6900 Bregenz
Tel: +43 (0)5574 6722-0

Germany

HEWI Heinrich Wilke GmbH
PO Box 1260
D-34442 Bad Arolsen
Tel: +49 (0)5691 82-0
Fax: +49 (0)5691 82-319
info@hewi.de
www.hewi.de

Touch-up markers (varnish)

Austria

VOTTELER Lacktechnik GmbH
Malvenstraße 7
A-4600 Wels
Tel: +43 (0)7242 759-0
Fax: +43 (0)7242 759-113
at.info@votteler.com
www.votteler.com

Germany

Heinrich König & Co. KG
An der Rosenhelle 5
D-61138 Niederdorfelden
Tel: +49 (0)6101 5360-0
Fax: +49 (0)6101 5360-11
info@heinrich-koenig.de
www.heinrich-koenig.de

FSG Schäfer GmbH
Boschstraße 14
D-48703 Stadtlohn
Tel: +49 (0)2563 9395-0
Fax: +49 (0)2563 9395-25
verkauf@fsg-schaefer.de
www.fsg-schaefer.de

Various accessory parts

Austria

Schachermayer
Großhandelsgesellschaft mbH
Schachermayerstraße 2-10
A-4021 Linz
Tel: +43 (0)732 6599-0
Fax: +43 (0)732 6599-1360
zentrale@schachermayer.at
www.schachermayer.at

Hueck + Richter Aluminium GmbH
Rossakgasse 8
A-1230 Vienna
Tel: +43 (0)1 667 1529-0
Fax: +43 (0)1 667 1529-141
www.hueck.at

Germany

Pauli + Sohn GmbH
Eisenstraße 2
D-51545 Waldbröl
Tel: +49 (0)2291 9206-0
Fax: +49 (0)2291 9206-681
www.pauli.de

SWS Gesellschaft für
Glasbaubeschläge mbH
Friedrich-Engels-Straße 12
D-51545 Waldbröl
Tel: +49 (0)2291 7905-0
Fax: +49 (0)2291 7905-10
info@sws-gmbh.de
www.sws-gmbh.de

Lauterbach GmbH
Heraeusstraße 22
D-06803 Bitterfeld-Wolfen/OT Greppin
Tel: +49 (0)3493 827676
Fax: +49 (0)3493 922906
info@lauterbach-gmbh.com
www.lauterbach-gmbh.com

* Fundermax assumes no liability for products of the listed companies with regard to their quality and suitability for specific applications.

10 Soffits and ceiling claddings

**“My work should, quite literally,
cause a stir.”**

(Sophie B., studying design)





Visible mechanical fastening with rivets or screws

Max Compact Interior panels can be mounted on an aluminum substructure using rivets or on a wooden substructure using screws. Due to the characteristics of the material, it is necessary to drill both fixed and sliding points.

Rear ventilation

As with soffits and ceiling claddings, sufficient rear ventilation must also be ensured (see chapter on wall cladding on p. 48).

Fixed points

Fixed points serve to evenly distribute (halve) the movements due to swelling and shrinkage. The diameter of the drill hole in the Max Compact Interior should be the same size as the diameter of the fastener. Drill one fixed point per panel as close as possible to the center of the element. Make all other fastening holes sliding points.

Sliding points

The diameter of the drill hole for the sliding points in the Max Compact Interior panel must be drilled larger than the diameter of the fastener, depending on the required expansion clearance. Shaft diameter of the fastener plus at least 2 mm per meter of cladding material starting from the fixed point. Fastener head must cover the drill hole. Set fasteners so that the panel can move. Set rivets with rivet gauge. The defined distance allows a movement of the parts in the borehole (clearance: 0.3 mm). Do not overtighten screws. Do not use countersunk screws, use washers if required.

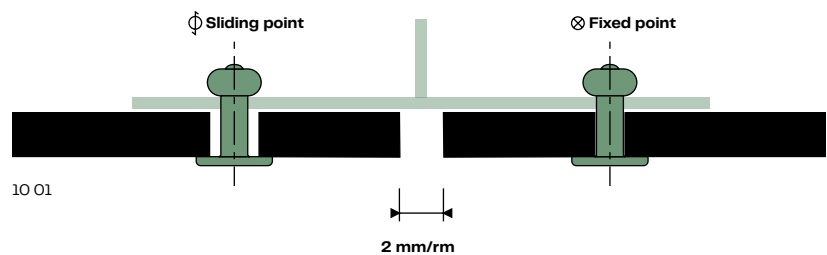

- 10 01 Example vertical joint
- 10 02 Suspended ceiling
- 10 03 Single span panel
- 10 04 Double span panel

Distance from edge

The edge spacings must be maintained for reasons of stability and flatness. The joints must be made at least 2 mm/m wide so that changes in size can take place without hindrance (see Fig. 10 2).

Mounting distances

These are to be chosen in accordance with the structural engineering requirements (calculations) or, if this is not necessary due to the local regulations, according to the Table.

Fasteners

It is essential that only fasteners made from noncorroding materials are used.

Max Compact installation screw with Torx 20 stainless steel X5Cr Ni Mo 17122 material No. 1.4401 V4A (painted head available upon request)

Diameter of the drill hole in Max Compact for installation with screw:

- Sliding points: 8 mm or as required
- Fixed points: 6 mm

Alu-Blind rivet with big head color lacquered or with covering cap for wall claddings with Max Compact panels on aluminum substructures

Rivet sleeve: material-no. EN AW-5019 acc. DIN EN 755-2

Rivet pin: steel material-no. 1.4541

Pull-off strength of rivet pin: ≤ 5.6 kn

Diameter of drill hole in Max Compact for installation with rivets:

- Sliding points: 8.5 mm or as required
- Fixed points: 5,1 mm

Diameter of drill hole in the aluminum substructure: 5.1 mm The rivets must be put in place with a flexible mouthpiece, clearance 0.3 mm. The rivet, flexible mouthpiece and riveting tool must be suited to each other.

You will find suppliers of fasteners on page 94 or on our website: www.fundermax.com

For installation with mechanical fasteners

Panel thickness	maximum fastening spacing "b" single span panel	maximum fastening spacing "a" double span panel
6 mm	350 mm	400 mm
8 mm	400 mm	450 mm
10 mm	450 mm	500 mm

⊗ Fixed point ◊ Sliding point

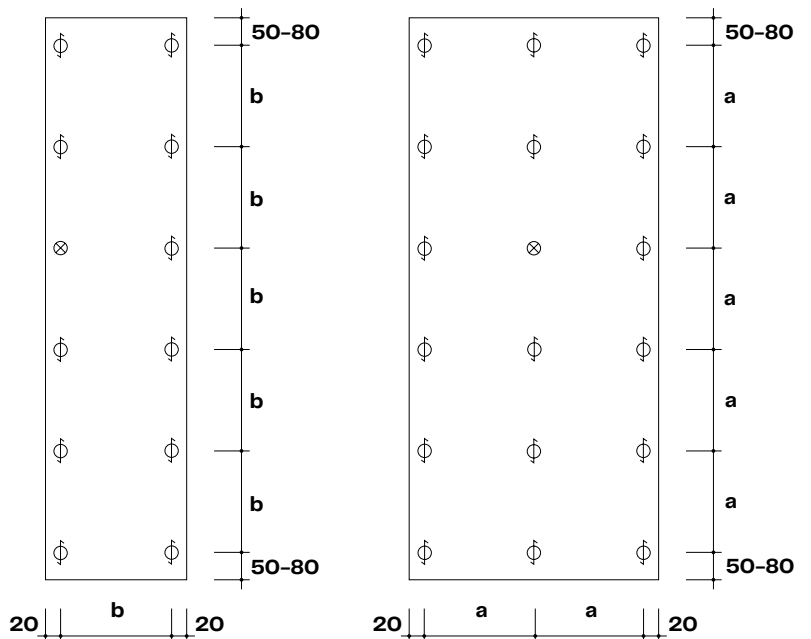

10 03

10 04

Secret fastening with adhesive system

Max Compact Interior panels can be attached to aluminum substructures using adhesive systems. The stability of the structure must be tested using static objects.

It is important that the respective construction supervisory body on a local or national level grants authorization. Due to the different regional building regulations, the construction supervisory board can demand for additional support structures by means of mechanical fixings (rivets, screws etc.).

The adhesion must be carried out following the processing regulations from the adhesive system manufacturer. Fundermax recommends using adhesive systems which are also approved by the building authorities for the mounting of curtain-type ventilated facades.

Pretreatment of aluminum

substructures:

- Grinding with abrasive fleece
- Clean with the adhesive manufacturer's cleaning agent
- Apply primer – follow manufacturer's recommendations.

Pretreatment of Max Compact panels:

- Grinding with abrasive fleece
- Clean with the adhesive manufacturer's cleaning agent
- Apply primer – follow manufacturer's recommendations.

All adhesive surfaces must remain clean, dry and grease-free. Throughout the construction process, it must be ensured that the adhesive system is not exposed to any stagnated moisture.

Suppliers/accessories for soffits and ceiling cladding

Fasteners (mechanical)

Austria

EJOT AUSTRIA GmbH
Graz suburb 146
A-8570 Voitsberg
Tel: +43 (0)3142 27600-0
Fax: +43 (0)3142 27600-30
info@ejot.at
www.ejot.at

SFS Intec GmbH
Wiener Straße 29
A-2100 Korneuburg
Tel: +43 (0)2262 90500102
Fax: +43 (0)2262 90500930
www.sfsintec.biz

Germany

MBE GmbH
Siemensstraße 1
D-58706 Menden
Tel: +49 (0)2373 17430-0
Fax: +49 (0)2373 17430-11
www.mbe-gmbh.de

Fischerwerke – Arthur Fischer GmbH & Co. KG
Weinhalde 14-18
D-72178 Waldachtal
Tel: +49 (0)7443 120
Fax: +49 (0)7443 124222
www.fischer.de

Netherlands

Ipex Europe B. V.
Vonderweg 14
NL-7468 DC ENTER
Tel: +31 (0)547 384635
Fax: +31 (0)547 384637
www.ipex-group.com

Switzerland

SFS intec AG (Headquarters)
 Rosenbergsaustasse 10
 CH-9435 Heerbrugg
 Tel: +41 (0)71 7276262
 Fax: +41 (0)71 7275307
 gmi.heerbrugg@sfsintec.biz
 www.sfsintec.biz

**Fastener
(adhesive)****Austria**

Fassadenklebetechnik Klug GmbH
 Head office
 Julius-Tandler-Platz 6/15
 A-1090 Vienna
 Tel: +43 (0)676 7271724
 office@fassadenklebetechnik.at
 www.fassadenklebetechnik.at

INNOTEK Industries
 Vertriebsgesellschaft mbH
 Floor 35
 A-6322 Kirchbichl
 Tel: +43 (0)5332 71138
 Fax: +43 (0)5332 72891
 www.innotec.at

PRO PART Handelsgesellschaft mbH
 Lauchenholz 28
 A-9122 St. Kanzian am Klopeinersee
 Tel: +43 (0)4239 40300
 Fax: +43 (0)4239 40300-20
 www.fassaden-kleben.at

Germany

Walter Hallschmid GmbH & Co. KG
 Wiesenstraße 1
 D-94424 Arnsdorf
 Tel: +49 (0)8723 96121
 Fax: +49 (0)8723 96127
 www.dichten-und-kleben.de

Switzerland

SIKA Chemie GmbH
 Tüffenwies 16-22
 CH-8048 Zürich
 Tel: +41 (0)58 4364040
 Fax: +41 (0)58 4364655
 www.sika.ch

Profiles/Accessories**Austria**

Protektor Bauprofile GmbH
 Tel: +43 (0)1 259 4500-0
 Fax: +43 (0)1 259 4500-19
 www.protektor.com

Helmut Lohr Company
 Elisabethstraße 36
 A-2380 Perchtoldsdorf
 Tel: +43 (0)699 11506880
 Fax: +43 (0)1 8674829
 info@lohrshop.com

Germany

Protector plant – Florenz Maisch
 GmbH & Co. KG
 Viktoriastraße 58
 D-72571 Gaggenau
 Tel: +49 (0)7225 977-0
 Fax: +49 (0)7225 977-111
 info@protektor.com
 www.protektor.com

France

PROTECTOR S.A. BATI PROFILE
 Rue Pasteur Prolongée
 F-94400 Vitry sur Seine
 Tel: +33 (0)1 55 531750
 Fax: +33 (0)1 55 531740

**Touch-up markers
(varnish)****Austria**

VOTTELER Lacktechnik GmbH
 Malvenstraße 7
 A-4600 Wels
 Tel: +43 (0)7242 759-0
 Fax: +43 (0)7242 759-113
 at.info@votteler.com
 www.votteler.com

Germany

Heinrich König & Co. KG
 An der Rosenhelle 5
 D-61138 Niederdorfelden
 Tel: +49 (0)6101 5360-0
 Fax: +49 (0)6101 5360-11
 info@heinrich-koenig.de
 www.heinrich-koenig.de

FSG Schäfer GmbH
 Boschstraße 14
 D-48703 Stadthlohn
 Tel: +49 (0)2563 9395-0
 Fax: +49 (0)2563 9395-25
 verkauf@fsg-schaefer.de
 www.fsg-schaefer.de

11 Table tops

**“We need to give space to ideas –
and the right table.”**

(Bettina F., entrepreneur)





Mounting distances

Max Compact Interior

Panel thickness	Mounting distance	Overhang
10 mm	320 mm	180 mm
12 mm	400 mm	250 mm

Application

Max Compact Interior panels are often used as table tops for school, desk, office, conference, lab or factory tables.

Resistance

Due to their pore-free surfaces and excellent chemical resistance, the panels are very easy to clean. Further advantages of these panels include their high scratch, tear and impact resistance.

Storage

Neither tables nor table panels should be stacked as the heavy stack weight can lead to damage.

Panel thickness

The thickness of the table top should either be 12 mm, or at least 10 mm, in order to allow enough depth for screwing. Both panel thickness and mounting distances as well as expected load platforms, are directly linked and must be measured correspondingly.

Mounting

Ensure that the installation is tension-free. Fastening can be done mechanically with screws that are either screwed directly into the panel or via sleeves with external and internal threads (e.g., Rampa sleeves). For this, the panels must be pre-drilled to establish a thread. Fastening the panels using screws takes place from the underside of the material. Therefore, metric thread and flat-head screws are suitable. Do not use countersunk screws, use washers if required.

Fastening points must be designed as sliding points. Based on how much space is needed for expansion, the diameter of the drill hole in the substructure should be that much larger than the diameter of the fastener. The screw head should always cover the drill hole. Set fasteners so that the panel can move. Do not overtighten screws. The center of the hole in the substructure must match the center of the hole in the Max Compact panel.

Drill with a centering aid! Start fastening the panels at the center of the panel and work outwards.

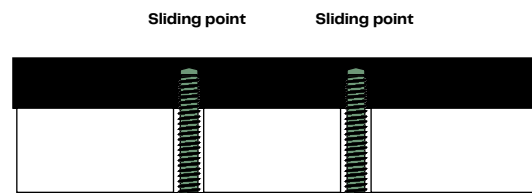

11 01

Examples when using Max Compact Interior 12 mm

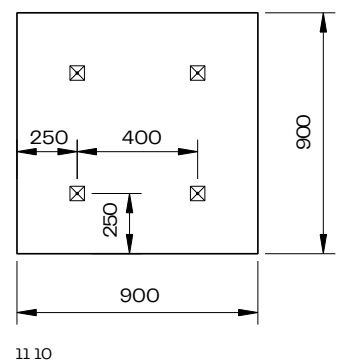
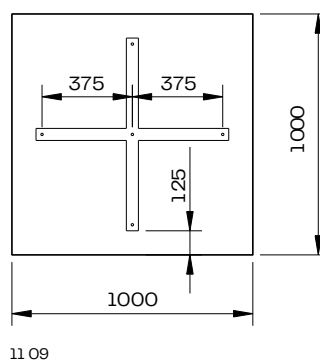
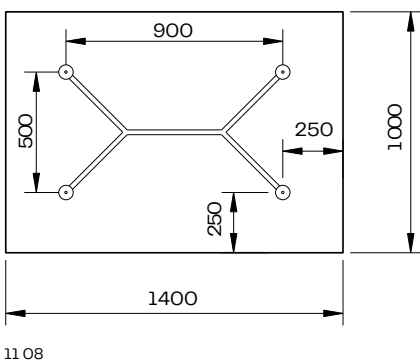
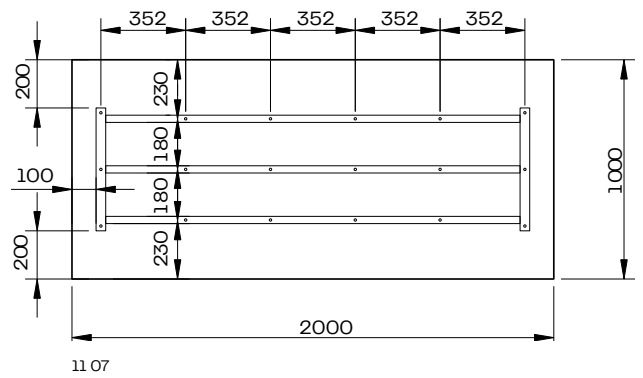
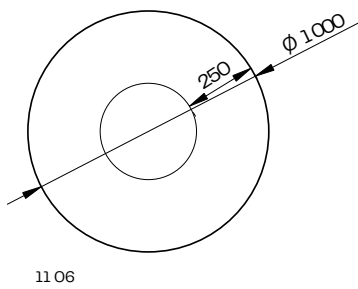
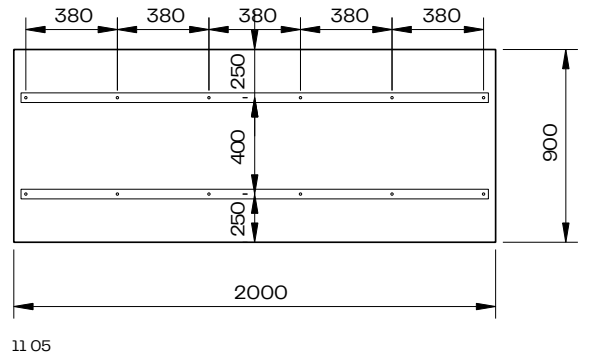
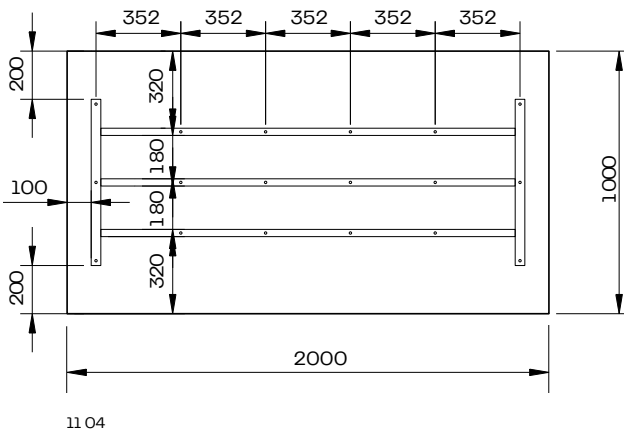
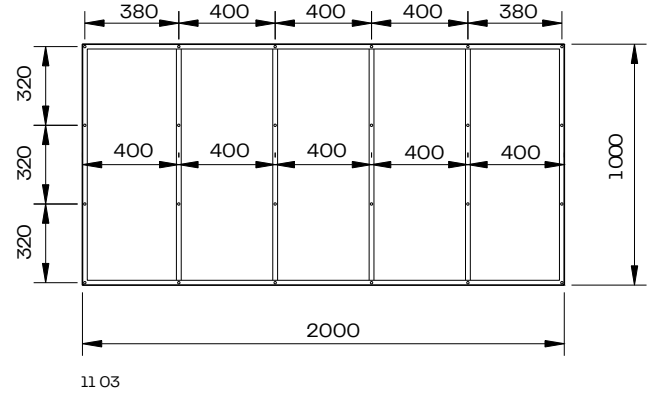
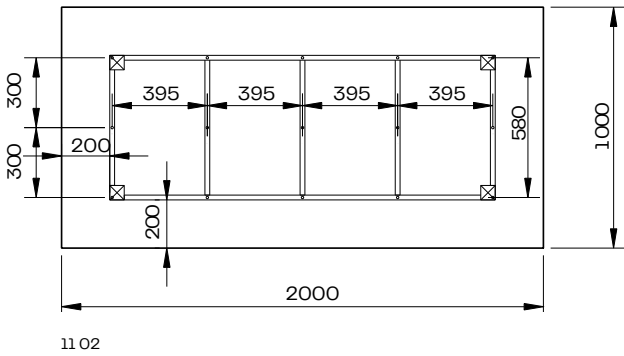

12 Furniture

**“The facility has to reflect my
creativity and quality.”**

(Philippa I., Interior Designer)





Cabinet body

Max Compact Interior is suitable for shop fittings, design applications, hospitals, or for home and office furniture.

In principle, the same panel connections used for conventional furniture construction can be used. It is not necessary to use the same panel strengths, but the connections must be made accordingly.

Due to the characteristics of the material, it is necessary to drill both fixed and sliding points. When using Max Compact Interior panels as corner joints (blunt or mitered), make sure that all parts have the same production direction. This means vertical with vertical and horizontal with horizontal. Mark production direction on any panel remnants.

Cabinet doors

There are only a few door hinges that are suitable for thin panels, which is why door elements can also be doubled up in the hinge area. To maintain symmetry, use the same panel material in the same thickness and decor.

Reactive adhesives, e.g., epoxy or solvent-free PU glues, are suitable for the adhesion process (see also Processing recommendations – Gluing).

- 12 01** Object hinge (from Prämeta company) for doors made of Compact panels, door thickness 10–13 mm; single-axis pivot point
- 12 02** Screw-on hinge for doors made of Compact panels
- 12 03** Angle, riveted
- 12 04** Angle, concealed screws
- 12 05** Connection with brass expansion bolt
- 12 06** Connection with tapped hole directly into the Compact panel
- 12 07** Screwed on the front side
- 12 08** Screwed on the front side, sectional view



12 01



12 02

Mechanical corner joints

Due to the usually low material thickness, it is best to fasten by means of screwing or riveting (blind rivets). Select drill hole diameters larger than the shaft diameters of the fasteners (dimensional changes). In keeping with the larger screw heads, use setting heads on rivets or washers.

Max Compact Interior corner joints can be produced along the entire length using brackets. This is necessary for very large surfaces and for supporting adhesive joints in wet rooms.

If screws are screwed into the back of the Compact panel from behind via the substructure, fixed and sliding points must be considered. A minimum panel thickness of 13 mm is necessary to ensure sufficient drilling material.

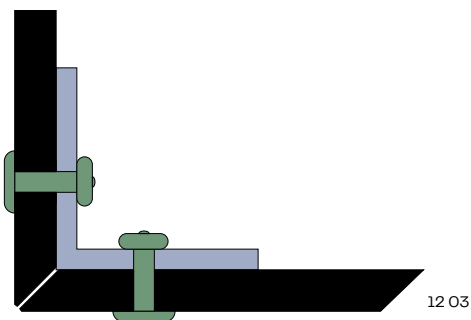

12 03

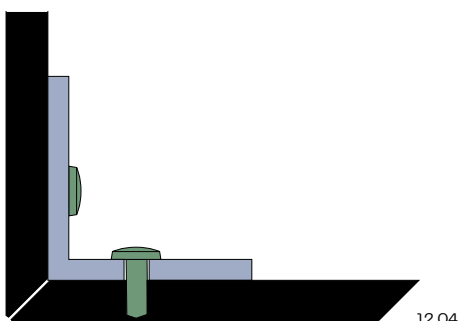

12 04

Other examples of mechanical connections

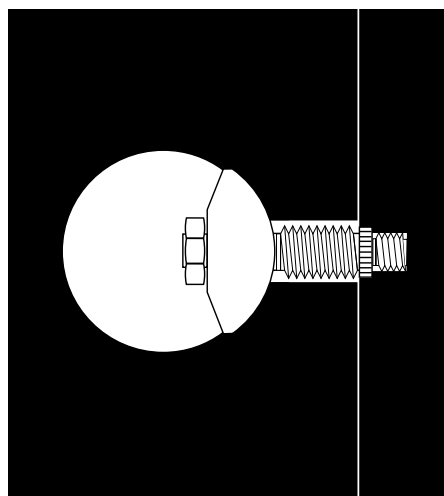

12 05

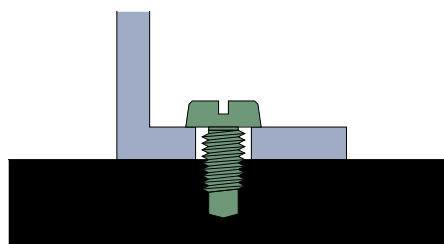

12 06

Thinner panels are drilled or riveted.

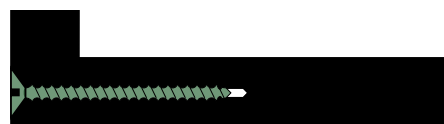

12 07

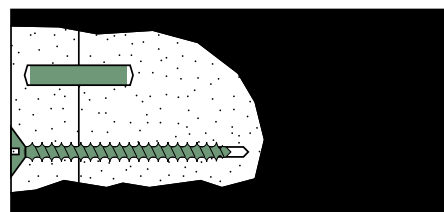

12 08

Furniture application examples

12 09 Body cladding trolley with individual decor

12 10 Drawer fronts

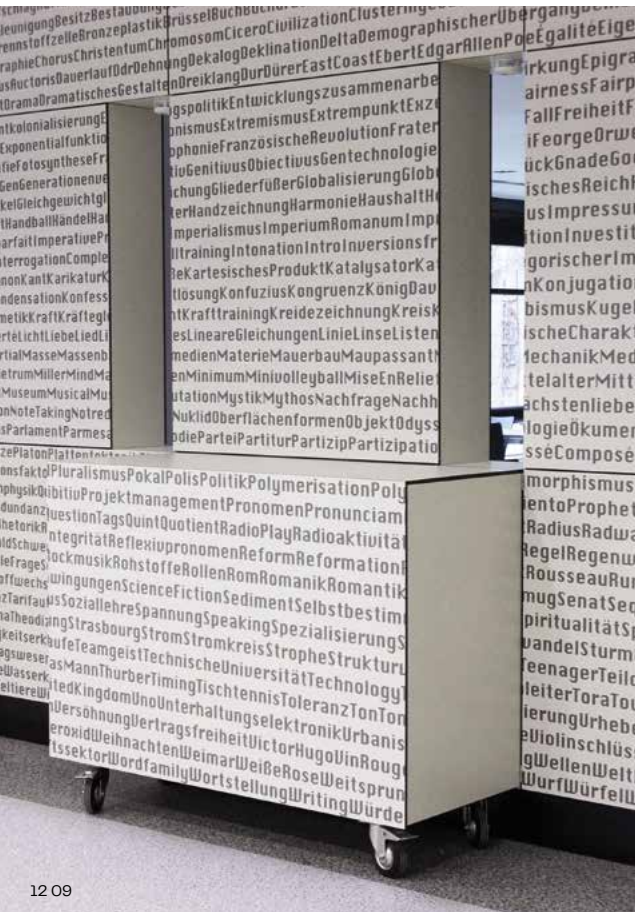

12 09



12 10

Suppliers

Fittings/Fasteners (mechanical)

Austria

Schachermayer Großhandelsgesellschaft mbH

Schachermayerstraße 2

Postfach 3000

A-4021 Linz

Tel: +43 (0)732 6599-0

Fax: +43 (0)732 6599-1360

info@schachermayer.at

www.schachermayer.at

Fa. Schmidtschläger

Hippgasse 17

A-1160 Vienna

Tel: +43 (0)1 523 4652-0

Fax: +43 (0)1 523 4652-16

service@schmidtschlaeger.at

www.schmidtschlaeger.at

Häfele Austria GmbH

Römerstraße 4

A-5322 Hof bei Salzburg

Tel: +43 (0)6229 39039-0

Fax: +43 (0)6229 39039-30

info@haefele.at

www.haefele.at

Germany

Prämeta GmbH & Co. KG

Genker Straße 16

D-53842 Troisdorf

Tel: +49 (0)2241 23996-0

Fax: +49 (0)2241 23996-22

info@praemeta.de

www.praemeta.de

Häfele GmbH & Co. KG

Adolf-Häfele-Straße 1

D-72202 Nagold

Tel: +49 (0)7452 95-0

Fax: +49 (0)7452 95-200

info@haefele.de

www.haefele.de

Hettich Holding GmbH & Co. OHG

Vahrenkampstraße 12-16

D-32278 Kirchlengern

Tel: +49 (0)5223 77-0

Fax: +49 (0)5223 77-1202

info@de.hettich.com

www.hettich.com

Deutsche Salice GmbH
Rudolf-Diesel-Straße 10
D-74382 Neckarwestheim
Tel.: +49 (0)7133 9807-0
Fax: +49 (0)7133 9807-16
info.salice@deutschesalice.de
www.deutschesalice.de

Netherlands

Ipex Europe B. V.
Vonderweg 14
NL-7468 DC ENTER
Tel.: +31 (0)547 384635
Fax: +31 (0)547 384637
www.ipex-group.com

Switzerland

Häfele Schweiz AG
Dammstrasse 29
CH-8280 Kreuzlingen
Tel.: +41 (0)71 6868200
Fax: +41 (0)71 6868282
info@haefele.ch
www.haefele.ch

Fastener (adhesive)

Austria

Fassadenklebetechnik Klug GmbH
Head office
Julius-Tandler-Platz 6/15
A-1090 Vienna
Tel.: +43 (0)676 7271724
office@fassadenklebetechnik.at
www.fassadenklebetechnik.at

Germany

Walter Hallschmid GmbH & Co. KG
Wiesenstraße 1
D-94424 Arnsdorf
Tel.: +49 (0)8723 96121
Fax: +49 (0)8723 96127
www.dichten-und-kleben.de

Switzerland

SIKA Chemie GmbH
Tüffenwies 16-22
CH-8048 Zürich
Tel.: +41 (0)58 4364040
Fax: +41 (0)58 4364655
www.sika.ch

Other adhesive suppliers

Austria

SIKA Österreich GmbH
Bingser Dorfstraße 23
A-6700 Bludenz
Tel.: +43 (0)5 0610-0
info@sika.at
www.sika.at

DKS Technik GmbH
Gnadenwald 90A
A-6069 Gnadenwald
Tel.: +43 (0)5223 48488-12
Fax: +43 (0)5223 48488-50
www.dks.at

INNOTECH Industries
Vertriebsgesellschaft mbH
Floor 35
A-6322 Kirchbichl
Tel.: +43 (0)5332 71138
Fax: +43 (0)5332 72891
www.innotec.at

Germany

SODAL N.V.
Olof-Palme-Straße 13
D-51371 Leverkusen
Tel.: +49 (0)214 6904-0
Fax: +49 (0)214 6904-23
www.soudal.com

Profiles/Accessories

Austria

Protektor Bauprofile GmbH
Tel.: +43 (0)1 2594500-0
Fax: +43 (0)1 2594500-19
www.protektor.com

Helmut Lohr Company
Elisabethstraße 36
A-2380 Perchtoldsdorf
Tel.: +43 (0)699 11506880
Fax: +43 (0)1 8674829
info@lohrshop.com

Germany

Protektorwerk –
Florenz Maisch GmbH & Co. KG
Viktoriastraße 58
D-76571 Gaggenau
Tel.: +49 (0)7225 977-0
Fax: +49 (0)7225 977-111
www.protektor.com

Touch-up markers (varnish)

Austria

VOTTELER Lacktechnik GmbH
Malvenstraße 7
A-4600 Wels
Tel.: +43 (0)7242 759-0
Fax: +43 (0)7242 759-113
at.info@votteler.com
www.votteler.com

Germany

Heinrich König & Co. KG
An der Rosenhelle 5
D-61138 Niederdorfelden
Tel.: +49 (0)6101 5360-0
Fax: +49 (0)6101 5360-11
info@heinrich-koenig.de
www.heinrich-koenig.de

FSG Schäfer GmbH
Boschstraße 14
D-48703 Stadtlohn
Tel.: +49 (0)2563 9395-0
Fax: +49 (0)2563 9395-25
verkauf@fsg-schaefer.de
www.fsg-schaefer.de

13 Worktops

“If you want staying power, you literally need the right foundation.”

(Jonas G., contractor)





Max Compact Interior as a worktop

Due to their high scratch and abrasion resistance as well as high impact resistance and resistance to high temperatures, Max Compact Interior panels are ideally suited for horizontal use as a worktop. Another advantage of these panels is the hygienically sealed, non-porous, closed surface made of melamine resin that is very easy to clean and is particularly resistant to many chemicals.

Panel thickness

For use as a worktop, the optimum panel thickness is 12 mm. Different panel thicknesses, fastening distances and the expected load capacity are all directly related and must be calculated accordingly.

Coloured core

For a permanently attractive appearance of the edgeband in areas subject to heavy wear, we recommend sealing the edgeband with clear lacquer.

Construction information

- Max Compact Interior panels shrink when releasing moisture and expand when absorbing moisture – take this into account during processing and construction.
- The dimensions are influenced by changes in relative humidity. It is therefore essential to ensure there is sufficient expansion clearance when installing the panels. Rule of thumb for the amount of expansion clearance needed:
2 mm for each meter of panel.
- When connecting Max Compact Interior panels to each other (corner joints butt or mitered), ensure that all parts to be connected are arranged in the same production direction (vertical with vertical and horizontal with horizontal). Leftover panel pieces should always be marked with the production direction.
- Base cabinets and substructures must have sufficient load-bearing capacity/stiffening. They should be aligned and height differences should be avoided.
- Do not make corner joints and worktop joints exclusively by gluing; these joints should always be supported by mechanical connections.
- Recesses/outlets for the sink, ceramic hobs, sockets, etc. must always have an inner radius of 5 mm. Pointed corners are not recommended.
- Protect material from accumulating moisture – the panel material must be able to dry. Ensure sufficient room ventilation.
- Visible edges or edges in the handle area must be chamfered or at least broken with sandpaper to avoid injuries and material damage.
- Do not mill into the surface – this maintains cleanability.
- Max Compact Interior panels with white core are not suitable for high traffic areas due to the increased visibility of soiling.

Note:

Fundermax reserves the right to make changes in the interest of technical progress.

Substructure

Ensure sufficient ventilation of both sides of the panel when installing. Different temperatures or moisture levels in front of and behind the countertop can cause the panels to warp.

To guarantee air circulation on the front and back of the panels, they should be placed on a sufficiently stable load-bearing substructure. If the base cabinets are not strong enough, they must be reinforced with additional elements. They should also be aligned and any height differences compensated for (e.g., by using a suitable spacer). For proper rear ventilation of Max Compact Interior panels, make the top of the kitchen cabinets open, so that air exchange can take place.

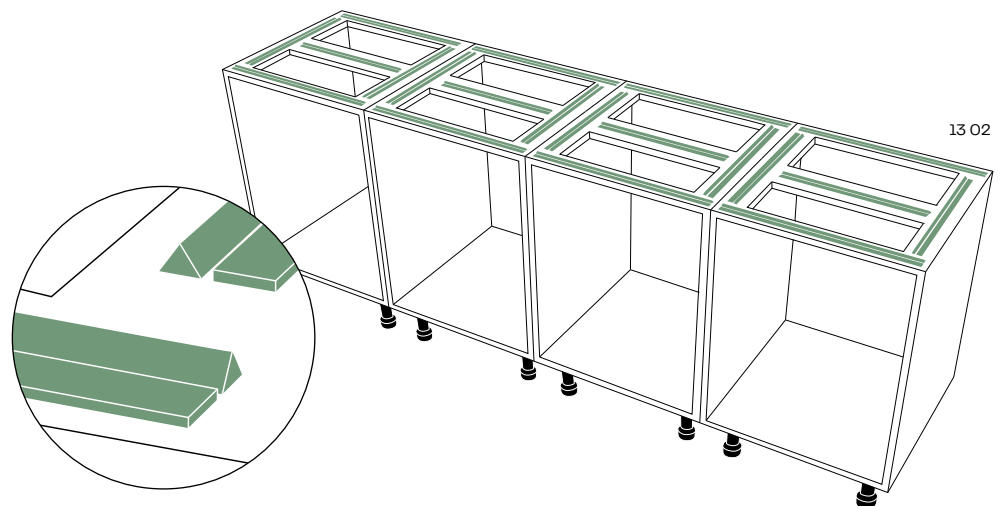

Mechanical fastening

Due to the material characteristics, the fixing points must be sliding points.

Fixed points

Fixed points serve to evenly distribute (halve) the movements due to swelling and shrinkage. The drill hole diameter in the Compact panel is the same as the diameter of the fastener. Drill one fixed point per panel as close as possible to the center of the element. Make all other fastening holes sliding points.

Sliding points

Based on how much space is needed for expansion, the diameter of the drill hole in the substructure should be that much larger than the diameter of the fasteners. The screw head should always cover the drill hole. Set fasteners so that the panel can move. Do not overtighten screws. The center of the hole in the substructure must coincide with the center of the hole in the Max Compact Interior panel. Drill with a centering aid!

Start fastening the panels at the center of the panel and work outwards. Ensure that the installation is tension-free. Fastening can be done mechanically with screws that are either screwed directly into the panel or via sleeves with external and internal threads (e.g., Rampa sleeves). For this purpose, predrill the panel one thread smaller than the screw or sleeve and observe the residual wall thickness of 2 mm (after deduction of all tolerances). Screws with a metric thread and a flat head are suitable. Do not use countersunk screws. If necessary, use washers if required.

Observe recommendations for drilling blind holes vertically and parallel to the slab surface in the chapter "Drilling" (see page 32).

Mounting

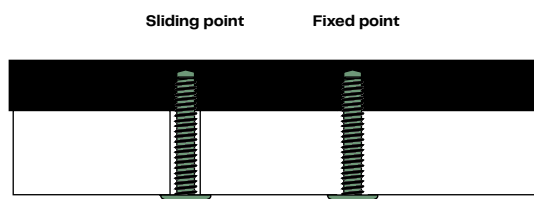

13 03

Fastening distances for mechanical fastening

Max Compact Interior

Panel thickness	Mounting distance	Distance from edge	Overhang
12 mm	550 mm	20-80 mm	50 mm

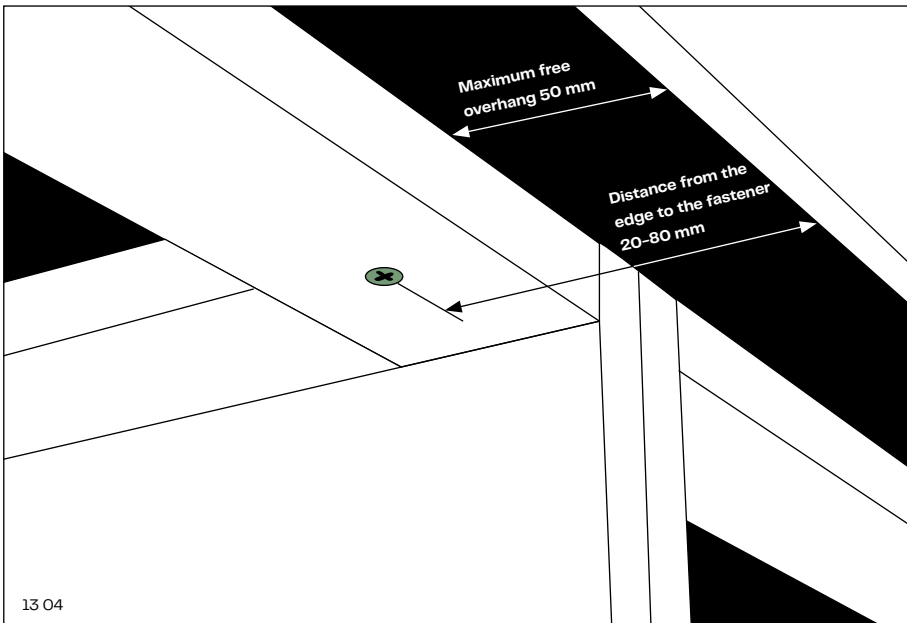

Glued fastening

As an alternative to hidden, mechanical fastening, facade adhesive systems from companies such as INNOTEK and SIKA are also suitable.

Recommendation for panel alignment: Peel off the cover film from only the corner of the double-sided adhesive tape. The weight of the panel can cause the tape to immediately adhere to the surface and make alignment more difficult.

Observe the processing guidelines of the adhesive manufacturer. Test the glue first under local conditions. Observe occupational health and safety regulations when working with adhesives, solvents and hardeners.

Fastening distances for glued fastening

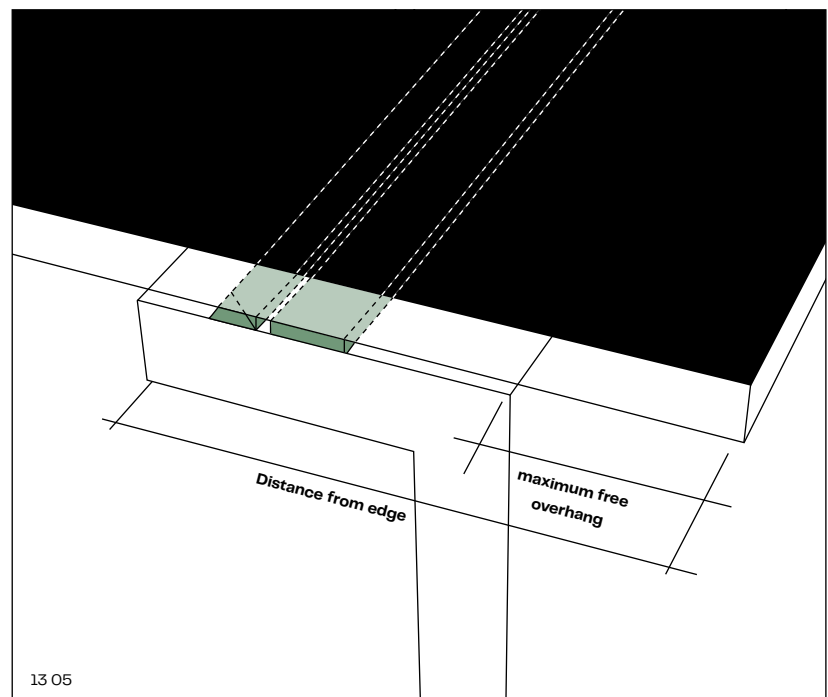

Max Compact Interior

Panel thickness	Mounting distance	Distance from edge	Overhang
12 mm	300 mm	20-80 mm	50 mm

Worktop joints

When making corner joints, it must be ensured that the kitchen base cabinets are aligned and any height differences should be compensated for using spacers. Level out worktop joints by means of a carpet pad. They must be made using suitable connection means – ensure that a wall thickness of 3 mm is maintained after subtracting all tolerances. Suitable connection means are anchors, grooves, biscuits, special milling, etc.

Observe the recommendations for drilling blind holes vertically and parallel to the panel surface in the chapter “Drilling” on page 32.

Using only glue for worktop joints is not recommended! Glued corner joints and worktop extensions should always be supported with mechanical connections.

When making worktop joints and connections to other furniture parts, walls, etc., observe the necessary expansion clearance for tension-free movement of the Max Compact Interior panels.

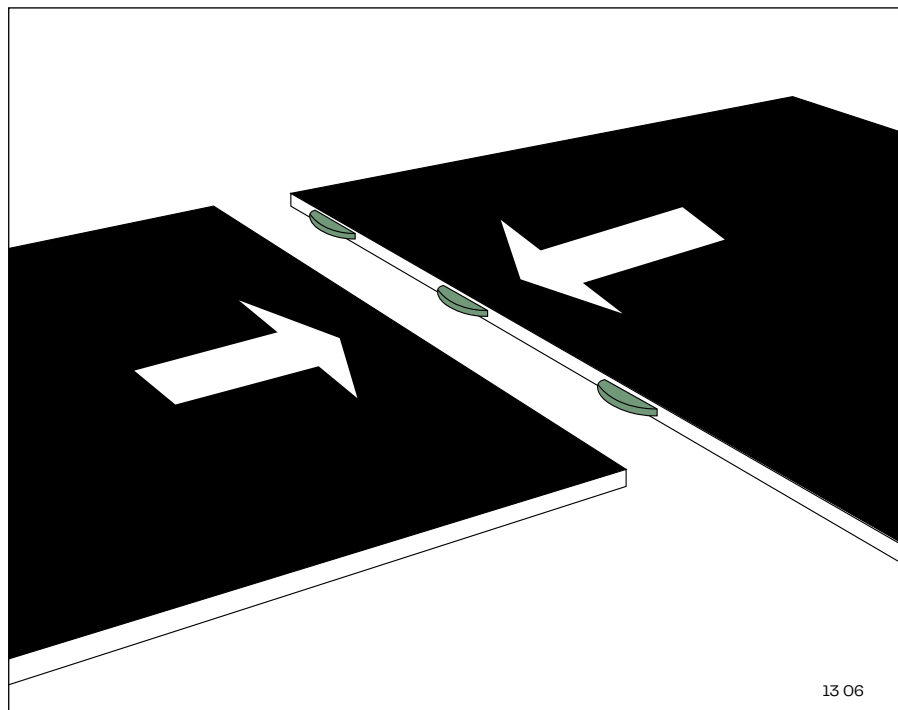

Sink and Glass Top Stove installation

Installation instructions

- Ensure sufficient expansion clearance. Rule of thumb: 2 mm/rm.
- Recesses/outlets must always be made with an inner radius of at least 5 mm. Pointed corners are not recommended.
- Ensure that all loads can be borne by the entire structure (e.g. with a full sink).
- When milling the Max Compact Interior panels, make sure that at least 50% of the panel thickness remains (e.g., 12 mm worktop – maximum milling of 6 mm). Otherwise, the worktop must be supported with a suitable substructure.
- Do not mill into the surface – this maintains cleanability.



Installation of Glass Top Stoves

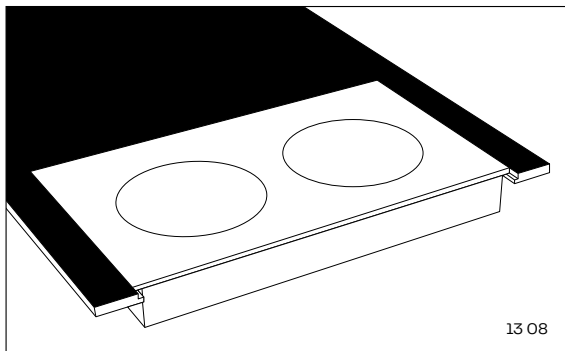

13 08

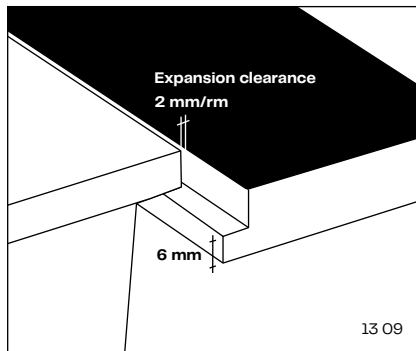

13 09

At least 6 mm panel thickness must remain.

- 13 07 Kitchen
- 13 08 Glass Top Stoves
- 13 09 Panel fold
- 13 10 recessed sink
- 13 11 Panel fold
- 13 12 bottom mount sink
- 13 13 Adhesive surface sink

Installation of recessed sink

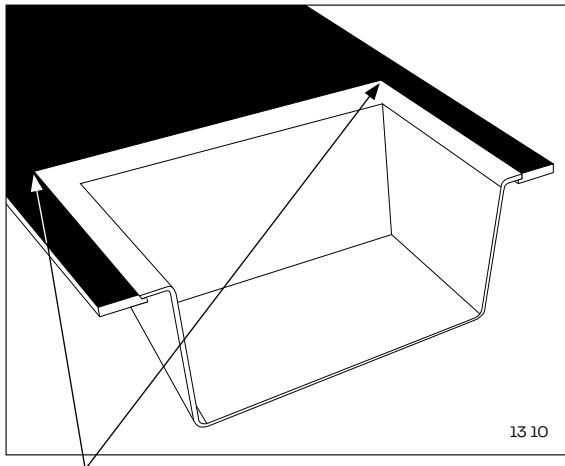

13 10

Always leave a radius of at least 5mm around inside corners.

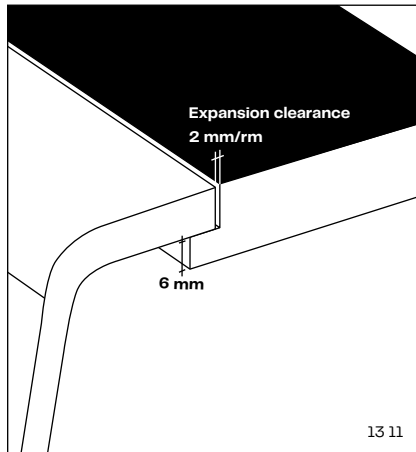

13 11

At least 6 mm panel thickness must remain.

Installation of bottom mount sink

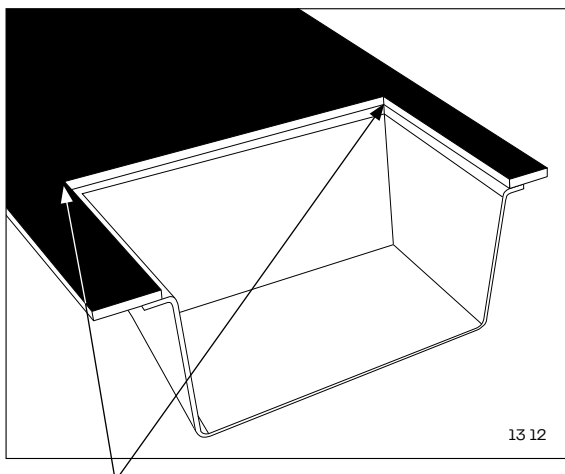

13 12

Always leave a radius of at least 5mm around inside corners.

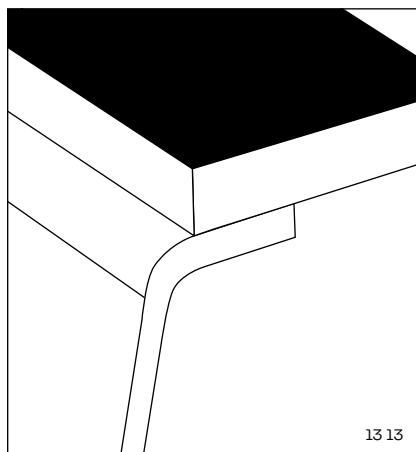

13 13

14 Wash basins

“Hygiene is essential – so are the facilities that enable it.”

(Patricia Z., practice manager)





Coloured core

For a permanently attractive appearance of the edgeband in areas subject to heavy wear, we recommend sealing the edgeband with clear lacquer.

General notes

Max Compact Interior panels are particularly suitable for furniture construction, bathroom fittings, office furniture, shop fittings and design applications.

Depending on the use, these panels can be used in furniture construction using the standard adhesive systems to join or mount materials together or to clad a corresponding substructure.

Construction information

- Max Compact Interior panels shrink when releasing moisture and expand when absorbing moisture – take this into account during processing and construction.
- Structures made of metal change their dimensions with temperature differences, Compact panels with changing relative humidity – this can be contrary, so care must be taken to ensure sufficient expansion clearance. Rule of thumb for the amount of expansion clearance needed: 2 mm/rm.
- When connecting Max Compact Interior panels with each other (corner joints, stumps or bevel cuts), make sure that the grain direction is the same (vertical with vertical and horizontal with horizontal). Leftover panel pieces should always be marked with the production direction. Support corner joints with anchors, springs, special milling, etc.
- For high levels of moisture, a mechanical connection of joints is indispensable when combined with an elastic and watertight bonding adhesive system.
- Protect material from accumulating moisture – panel material must be allowed to dry.
- For use in wet rooms, a sufficient ventilation system in the room is important.
- Visible edges, or edges within reach must be beveled or at least sanded down using sandpaper to prevent injuries and damages to the material.
- Do not mill into the surface – this maintains cleanability.

Note:

Fundermax reserves the right to make changes in the interest of technical progress.



14 01

Installation possibilities for wash basins using Max Compact panels

The simple solution

Cutting out/screwing in an “insertable washbasin.”

Notes:

Max Compact Interior panels with white core are not suitable for high traffic areas due to the increased visibility of soiling.

Coloured core: For a permanently attractive appearance of the edgeband in areas subject to heavy wear, we recommend sealing the edgeband with clear lacquer.

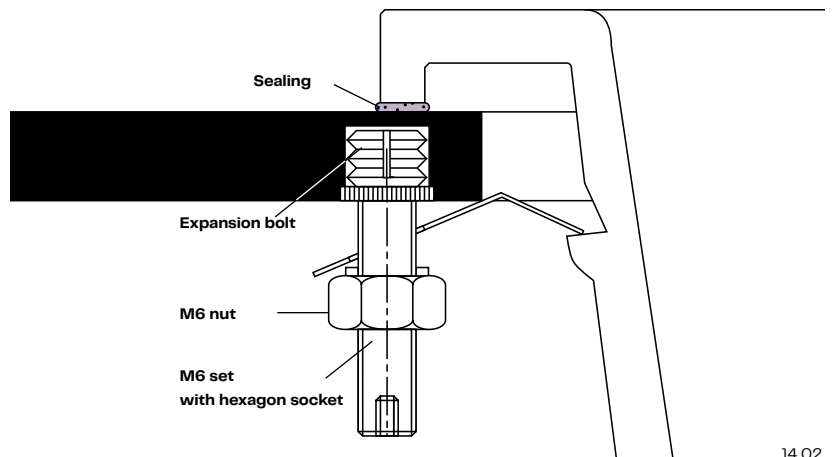

14 02

The rational solution

Milling Max Compact panels and unscrewing the built-in wash basin.

For high quantities of components, the milling can be done with a table router using template.

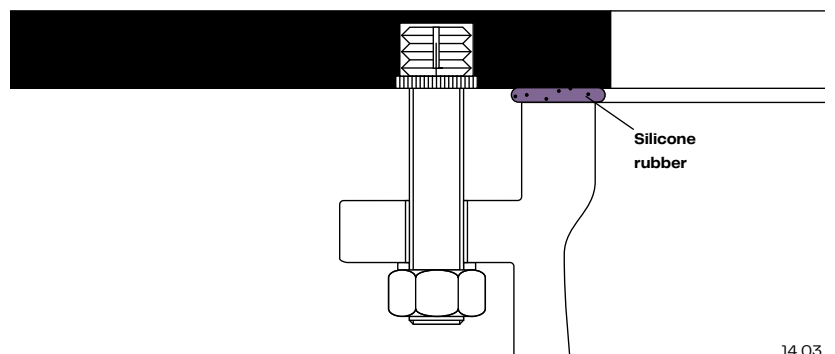

14 03

The elegant solution

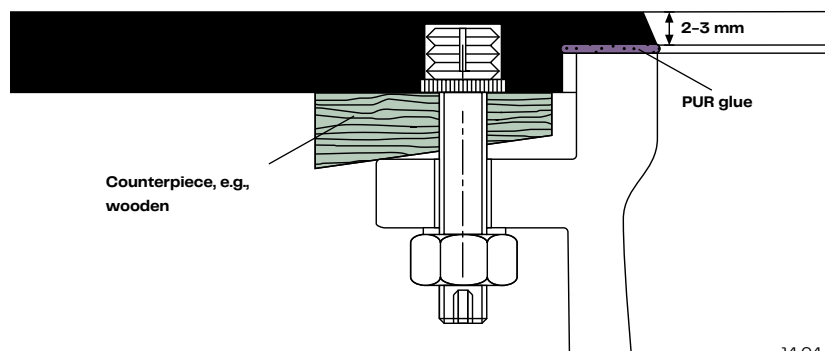

14 04

- 14 01 Bathroom
- 14 02 Insert wash basin
- 14 03 Built-in wash basin
- 14 04 Built-in wash basin, recessed

15 Railings

**“The task is to combine design
and safety.”**

(Matteo V., Architect)





General notes

Max Compact Interior panels can be mounted in different ways onto railings and balustrades. They can be screwed or riveted to a substructure or fastened using glass clamps.

Max Compact Interior panels shrink when releasing moisture and expand when absorbing moisture – take this into account during the processing and construction process. Structures made of metal change their dimensions with temperature differences, Compact panels with changing relative humidity – this can be contrary, so care must be taken to ensure sufficient expansion clearance. Rule of thumb for the amount of expansion clearance needed: 2 mm/ mm.

Construction information

- Max Compact Interior panels should only ever be mounted as infill panels for supporting substructures.
- Protect material from accumulating moisture – panel material must be allowed to dry.
- When connecting Max Compact Interior panels to each other (corner joints butt or mitered), ensure that all parts to be connected are arranged in the same production direction (vertical with vertical and horizontal with horizontal). Leftover panel pieces should always be marked with the production direction.
- Protect substructure against corrosion/ rotting.
- All edges within reach must be sanded, V-joints form between the panel joints.



15 01 Railing infill mechanically fastened

15 02 Minimum distances between perforations with fall protection

15 03 Staircase railing – hole milling

Railing fillings with hole patterns:

- The panel thickness is directly related to the mounting distance.
- The mounting brackets must comply with the static requirements and local building regulations. However, for perforated panels the distance between the brackets must be reduced by at least 20%.
- Holes or slots must be arranged in such a way that children can not use them for climbing. Holes should not be larger than 50 mm in diameter.
- For recesses, we recommend using thicker panels in accordance with fall protection standards.
- The webs between the holes or slots must be at least as wide as the diameter of the holes or slots. This also applies for distances from the edge.

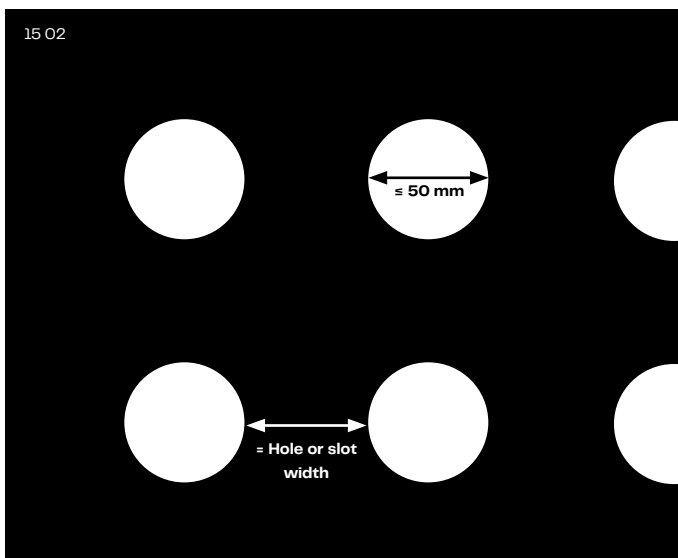
**Austria****OIB-RL 4.1.3/ÖNORM B5371 Pkt. 12:**

- maximum vertical opening width: 12.0 cm
- max. vertical opening width: 2.0 cm

Germany**DIN 18065: 2001-01/State Building Regulations:**

- max. horizontal opening width for bar constructions: 12.0 cm
- max. vertical opening width: 2.0 cm
- Diagonal dimension for horizontal board or bar constructions as well as lattice constructions: 4.0 cm

Switzerland**SIA Standard 358/Specialist brochure BFU – Beratungsstelle für Unfallverhütung [advice for accident prevention]:**

- For GF 1, openings in the protective elements must not have a diameter larger than 12 cm up to a height of 75 cm. Prevent climbing by measures – e.g., gap of horizontal crossbars (openings) should be only 1–3 cm.
- grid-like hole drilling: maximum 4 cm opening width
- Round holes: maximum 5 cm opening width

Note:

For variations related to the project, please speak to the responsible building authority.

Fastening points

There should usually be three fastening points in every direction. Structural evidence must be shown. The stability of the railing is guaranteed by the processor.

Fundermax points out that this information relates to height distances and can only be used for flawless connections. Adequate screw and rivet dimensions must be adhered to.

Note:

In the Fundermax brochure “Technique Exterior” (www.fundermax.com – Downloads) we demonstrate different mounting possibilities for railings with Compact panels, which have all been tested and approved by the “ETB Guidelines for structural elements that protect against falls” (6.1.85).

Mounting distances for balcony screws

Max Compact panel thickness	AW	AS	E
8 mm	≤ 1000 mm	≤ 400 mm	20-200 mm
10 mm	≤ 1100 mm	≤ 500 mm	20.0-250 mm

Mounting distances for clamping brackets

Max Compact panel thickness	AW	AS	E
8 mm	≤ 950 mm	≤ 450 mm	20-160 mm
10 mm	≤ 1100 mm	≤ 500 mm	20-200 mm

Mounting distances for rivets

Max Compact panel thickness	AW	AS	E
8 mm	≤ 950 mm	≤ 350 mm	20-200 mm
10 mm	≤ 1000 mm	≤ 400 mm	20.0-250 mm

⊗ Fixed point

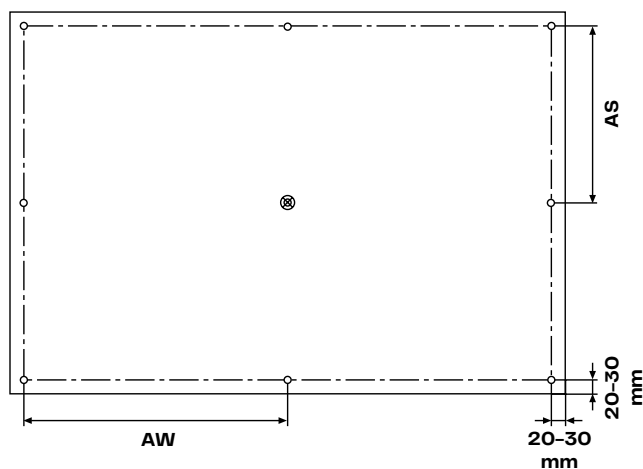

Mounting varieties

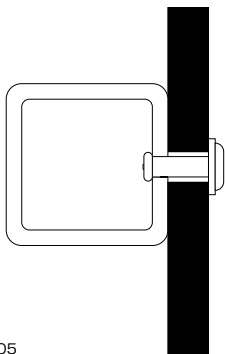

15 05

Direct fastening using blind rivets with flat round-head
5 x 21 mm stainless steel and rivet washers NR 8; inner diameter: 5.1 mm; set rivets with hinge tips.

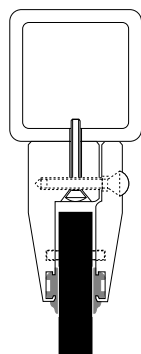

15 06

Mounting devices screwed to the railing tube
(e.g., Schüco, Alu-königstahl, Längle)

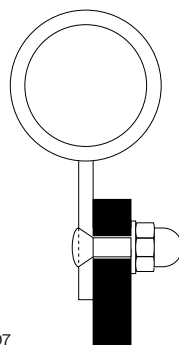

15 07

Welded steel handles with raised countersunk head screws
M6 x 20 DIN 964 and cap nut M6 DIN 1587 (stainless steel)

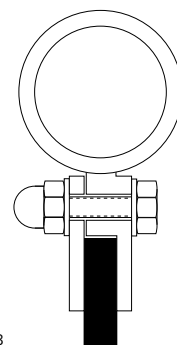

15 08

Welded steel handles with two clamping plates and hexagon bolts
M6 x 25 DIN 933, cap nut M6 DIN 1587 and sheets M6 DIN 121 A (stainless steel)

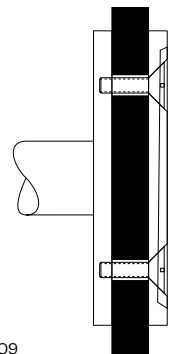

15 09

Fastening of Compact panels with pairs of circular plates (5 mm thick); the base plates are welded flush to aligned projections jutting from vertical rail stanchions. The cover plates are screwed with two stainless steel countersunk screws (M6 x 20 DIN 963) through the drill holes of the Compact panel (expansion clearance!) to the base plates.

15 04 Mounting distances

15 05 Blind rivet fastening

15 06 Glass clamp holder fastener

15 07 Lens countersunk head screw fastening

15 08 Clamp plates brackets

15 09 Mounting, base panel & cover plate

Suppliers/accessories for railings*

Various accessory parts

Austria

Schachermayer
 Großhandels-gesellschaft mbH
 Schachermayerstraße 2-10
 A-4021 Linz
 Tel: +43 (0)732 6599-0
 Fax: +43 (0)732 6599-1360
 zentrale@schachermayer.at
 www.schachermayer.at

Hueck + Richter Aluminium GmbH
 Rossakgasse 8
 A-1230 Vienna
 Tel: +43 (0)1 6671529-0
 Fax: +43 (0)1 6671529-0
 www.hueck.at

ALUKÖNIGSTAHL GmbH
 Goldschlagstraße 87-89
 A-1150 Wien
 Tel: +43 (0)1 98130-0
 Fax: +43 (0)1 98130-64
 office@alukoenigstahl.com
 www.alukoenigstahl.com

Germany

Pauli + Sohn GmbH
 Eisenstraße 2
 D-51545 Waldbröl
 Tel: +49 (0)2291 9206-0
 Fax: +49 (0)2291 9206-681
 www.pauli.de

SWS Gesellschaft für
 Glasbaubeschläge mbH
 Friedrich-Engels-Straße 12
 D-51545 Waldbröl
 Tel: +49 (0)2291 7905-0
 Fax: +49 (0)2291 7905-10
 info@sws-gmbh.de
 www.sws-gmbh.de

Lauterbach GmbH
 Heraeusstraße 22
 D-06803 Bitterfeld-Wolfen/OT
 Greppin
 Tel: +49 (0)3493 827676
 Fax: +49 (0)3493 922906
 info@lauterbach-gmbh.com
 www.lauterbach-gmbh.com

SCHÜCO International KG
 Karolinenstraße 1-15
 D-33609 Bielefeld
 Tel: +49 (0)521 7830
 Fax: +49 (0)521 783451
 info@schueco.com
 www.schueco.com

NORMBAU – Beschläge und
 Ausstattungsgesellschaft mbH
 Schwarzwaldstraße 15
 D-77871 Renchen
 Tel: +49 (0)78 43704-0
 Fax: +49 (0)78 43704-43
 info@normbau.de
 www.normbau.de

HEWI – Heinrich Wilke GmbH
 Prof.-Bier-Straße 1-5
 D-34454 Bad Arolsen
 Tel: +49 (0)5691 82-0
 Fax: +49 (0)5691 82-319
 info@hewi.de
 www.hewi.de

* Fundermax assumes no liability for products of the listed companies with regard to their quality and suitability for specific applications.

Disclaimer

The information made available in this document is exclusively for the purposes of general information. Not all of the systems mentioned and shown in this document are suitable or appropriate for all areas of application. All customers and third parties are obligated to inform themselves thoroughly about Fundermax products, including their suitability for certain purposes. We explicitly recommend that you and other users of this document seek out independent expert advice on adherence to local planning and use requirements, applicable laws, regulations, standards, guidelines and testing standards. Fundermax accepts no liability in connection with the use of this document. Responsibility for correct and appropriate planning and workmanship lies exclusively with those planning or processing the materials. All of our spoken and written statements, offers, bids, sales, shipments and/or contracts as well as all related activities are subject to the General Terms and Conditions of Sale of Fundermax GmbH in the currently valid version (see www.fundermax.com).

Copyright

All texts, photos, graphics, audio and video files are subject to copyright and other laws protecting intellectual property and may not be duplicated, altered or used on other websites for purposes or business, etc.

Fundermax Deutschland GmbH

Mundenheimer Weg 2
67117 Limburgerhof, Germany
infogermany@fundermax.biz
www.fundermax.com

Fundermax France S.a.r.l.

3 Cours Albert Thomas
69003 Lyon, France
Tel: +33 (0)4 78682831
infofrance@fundermax.biz
www.fundermax.com

Fundermax India Pvt. Ltd.

Sy. No. 7, Honnenahalli, Doddballapur Road,
Yelahanka Hobli, Bangalore – 560064, India
officeindia@fundermax.biz
www.fundermax.in

Fundermax Italia s.r.l.

Viale Venezia 22
33052 Cervignano del Friuli, Italy
infoitaly@fundermax.biz
www.fundermax.com

Fundermax North America, Inc.

9401-P Southern Pine Blvd.
Charlotte, NC 28273, U.S.
Tel: +1 (0)980 2990035
office.america@fundermax.biz
www.fundermax.us

Fundermax Polska Sp. z o.o.

ul. Rybitwy 12
30-722 Kraków, Poland
Tel: +48 (0)12 6534528
infopoland@fundermax.biz

Fundermax Swiss AG

Industriestrasse 38
5314 Kleindöttingen, Switzerland
Tel: +41 (0)56 2688311
infoswiss@fundermax.biz
www.fundermax.com

Fundermax GmbH

Klagenfurter Straße 87–89, 9300 St. Veit/Glan, Austria
T: +43 (0)5 9494–0, F: +43 (0)5 9494–4200
office@fundermax.at
www.fundermax.com

