

Product Options

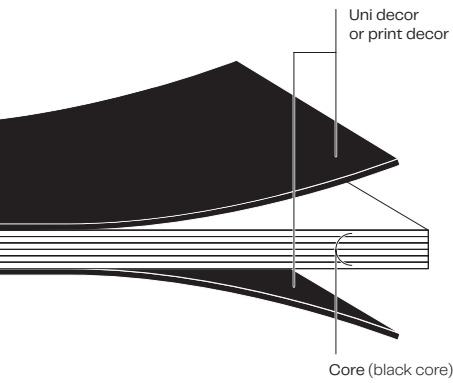

Max Compact Interior

is a highly versatile product fit for all of the design challenges a washroom environment poses.

- Max impact resistance
- Max moisture resistance
- Max stability
- Max durability
- Max hygiene

Max Compact Interior is the perfect solution for cubicles, IPS, lockers and benches.

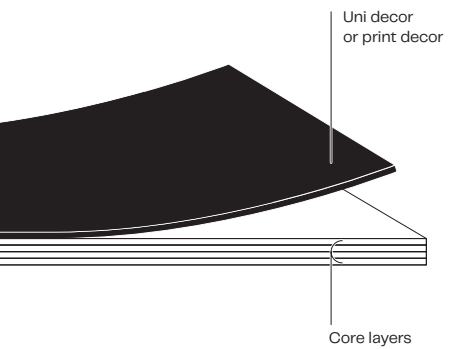

Max HPL

offers the perfect solution for IPS, vanity units, doors and wall linings with its unique properties allowing the fabrication of detailed components for your washroom. Postforming of HPL allows a continuous, closed surface of the core board across the edges.

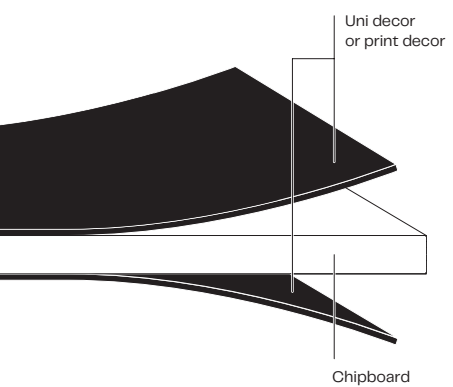

Star Favorit MFC

(Melamine Faced Chipboard) is offered here with our high performing moisture resistant (P3) core. MFC is the ideal panel solution for carcasses & low-impact areas and provides a cost-effective solution to matching decors throughout your scheme.

Individualdecor

For totally individual projects, we offer our custom printed panel solutions. We take your high resolution images and encapsulate them in our high performance surfaces (Compact or HPL).



Fundermax

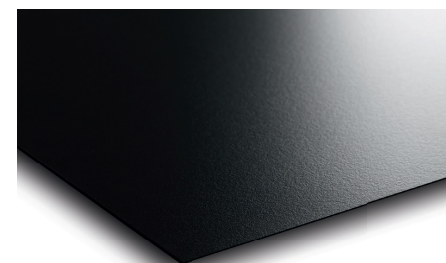
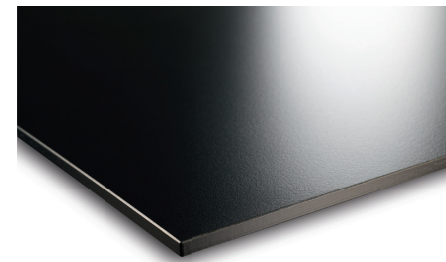

Washroom Collection

HPL, Compact, MFC



0074 FH
Pastel Grey



0210 FH
Intensive Red



0682 FH
Orange



0718 FH
Arctic



0717 FH
Atlantic

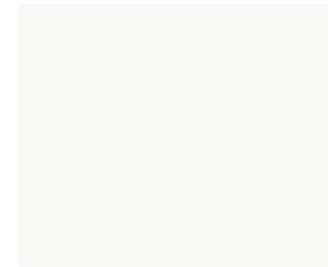

0606 FH
Arctic White



0762 FH
Neutral Grey Medium



2206 FH
Fango



0010 FH
Mango



0630 FH
Sea Green



0023 FH
Lamar

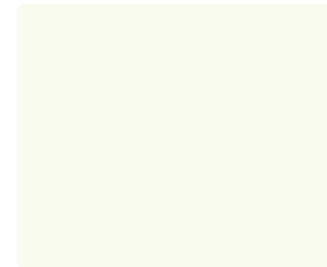

0085 FH
White



0077 FH
Charcoal



0761 FH
Neutral Grey Dark



0725 FH
Yellowish Green

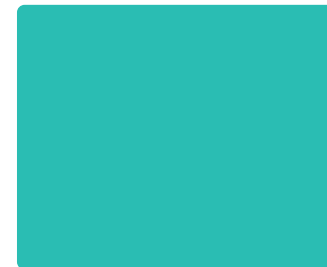

0876 FH
Frosted Teal



0237 FH
Gentian Blue

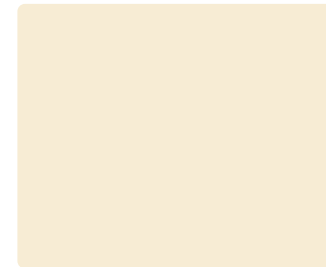

0733 FH
Hygienic White



0080 FH
Black



0755 FH
Warm Grey Dark



0893 FH
Emerald Green



0591 FH
Fir Green



0842 FH
Blackberry Cupcake

Fundermax

Washroom Collection

HPL, Compact, MFC



0260 FH
Arezzo Walnut



0607 FH
Loen Ash



0026 FH
Prado Alu Grey



0940 FH
Truffle Cottage Oak



0361 FH
Serenissima Ash



0027 FH
Prado Agate Grey



0419 FH
Pinero Pine



0551 FH
Whitney Chestnut



0328 FH
Brushed Aluminium



4029 FH
Dark Eucalyptus



4059 FH
Lionga Elm



0559 FH
Punto Pastel Grey

Fundermax

Properties*

All our products are manufactured in line with EN438 and EN312.

- Easy to clean
- Scratch resistant
- Ease of installation
- Durable
- Impact resistant
- Food grade
- Excellent chemical resistance

*All properties and information about our products you will find on our website www.fundermax.com

Fundermax

100% recycled content using eco-friendly energy

- 100% Recycle Paper Products.
- 100% Self-Generated Energy.
- Supplying Electricity to 1000's of homes and businesses.



Installation with decors O551 and O725



O551 FH
Whitney Chestnut



O725 FH
Yellowish Green



Installation with decors O260 and O733



O260 FH
Arezzo Walnut

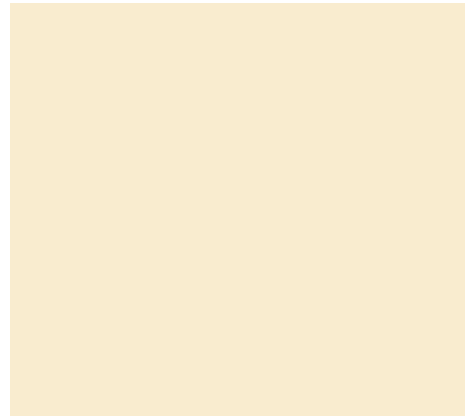

O733 FH
Hygienic White



Installation with decors O023 and O630



O023 FH
Lamar



O630 FH
Sea Green

Full pattern repeats shown for reference. Decors may differ to the original due to limitations of the printing process.

Delivery Program

Decor Group	Decor No.	Surface Finish	Name	LRV	Nearest NCS-Code	Nearest RAL no.	HPL				Grain	
							4100 x 1300 mm	3660 x 1630 mm	2800 x 1854 mm	2800 x 2070 mm		
Plain colours							Thickness	0.8	12	12	19	
U	0010	FH	Mango	0.59	S 0580-Y10R	1003	•	•	•	•	N	
U	0023	FH	Lamar	0.16	S 5030-R90B	5023	•	•	•	•	N	
U	0074	FH	Pastel Grey	0.48	S 2500-N	7038	•	•	•	•	N	
U	0077	FH	Charcoal	0.11	S 7005-R50B	7015	•	•	•	•	N	
U	0080	FH	Black	0.06	S 9000-N	9005	•	•	•	•	N	
U	0085	FH	White	0.85	S 0502-G50Y	9010	•	•	•	•	N	
U	0210	FH	Intensiv Red	0.20	S 0580-Y90R	3020	•	•	•	•	N	
U	0237	FH	Gentian Blue	0.10	S 5040-R80B	5010	•	•	•	•	N	
U	0591	FH	Fir Green	0.09	S 7020-B90G	6005	•	•	•	•	N	
U	0606	FH	Arctic White	0.80	S 0502-R50B	9003	•	•	•	•	N	
U	0630	FH	Sea Green	0.54	S 2010-B70G	-	•	•	•	•	N	
U	0682	FH	Orange	0.33	S 0570-Y60R	2008	•	•	•	•	N	
U	0717	FH	Atlantic	0.20	S 2060-R90B	5015	•	•	•	•	N	
U	0718	FH	Arctic	0.54	S 1030-R90B	-	•	•	•	•	N	
U	0725	FH	Yellowish Green	0.53	S 1060-G60Y	-	•	•	•	•	N	
U	0733	FH	Hygienic White	0.75	S 0804-Y30R	9001	•	•	•	•	N	
U	0755	FH	Warm Grey Dark	0.18	S 6502-Y	7005	•	•	•	•	N	
U	0761	FH	Neutral Grey Dark	0.20	S 6000-N	7037	•	•	•	•	N	
U	0762	FH	Neutral Grey Medium	0.34	S 4000-N	7042	•	•	•	•	N	
U	0842	FH	Blackberry Cupcake	0.19	S 4030-R40B	4001	•	•	•	•	N	
U	0876	FH	Frosted Teal	0.39	S 2040-B60G	-	•	•	•	•	N	
U	0893	FH	Emerald Green	0.13	S 4050-G	6016	•	•	•	•	N	
U	2206	FH	Fango	0.31	S 4005-Y50R	-	•	•	•	•	N	
Nature Decors												
H	0260	FH	Arezzo Walnut	0.17			•	•	•	•	R	
H	0361	FH	Serenissima Ash	0.41			•	•	•	•	R	
H	0419	FH	Pinero Pine	0.16			•	•	•	•	R	
H	0551	FH	Whitney Chestnut	0.27			•	•	•	•	R	
H	0607	FH	Loen Ash	0.50			•	•	•	•	R	
H	0940	FH	Truffle Cottage Oak	0.17			•	•	•	•	R	
H	4029	FH	Dark Eucalyptus	0.09			•	•	•	•	R	
H	4059	FH	Lionga Elm	0.32			•	•	•	•	R	
Material Decors												
M	0026	FH	Prado Alu Grey	0.29			•	•	•	•	R	
M	0027	FH	Prado Agate Grey	0.11			•	•	•	•	R	
M	0328	FH	Brushed Aluminium	0.42			•	•	•	•	R	
M	0559	FH	Punto Pastel Grey	0.43			•	•	•	•	N	
M	3426	FH	Scandio	0.17			•	•	•	•	R	

Distributed by:

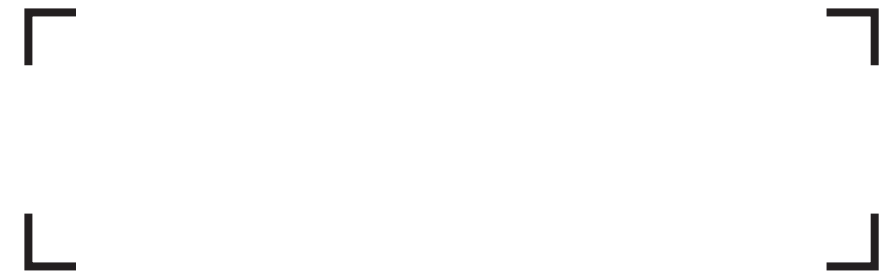

All items are stocked in the UK. No minimum order quantities.

FH - Fine Hammer Embossed
The classic, which can be used in practically all areas, offers the optimum combination of resistance and easy cleanability - and is therefore one of the most popular surfaces.

Decor direction
N = This decor doesn't have a direction. It can be turned when cutting.
R = This decor goes in a crosswise direction. (Please consider when arranging and cutting.)

Note: All items are polycoated and are suitable for horizontal and vertical use.

Matching ABS edging is available from Rehau. For further information please contact our sales representatives.

For more options and further technical information about applications and our products, such as digital print (Individualdecor), Max Compact Interior with white core, and many more, as well as for further decors and our delivery programme please visit our website www.fundermax.com

Did you know?
We already cover half of our core paper requirements entirely with recycled core paper, which we obtain primarily from our Fundermax subsidiary Ranheim Paper & Board in Norway, a manufacturer of paper and board products.



Fundermax GmbH
A-9300 St. Veit/Glan
Klagenfurter Strasse 87-89
Tel: + 43(0) 5/9494-0
Fax: + 43(0) 5/9494-4210
sales.uk@fundermax.biz
www.fundermax.com

Washroom Collection

For you to create

Fundermax

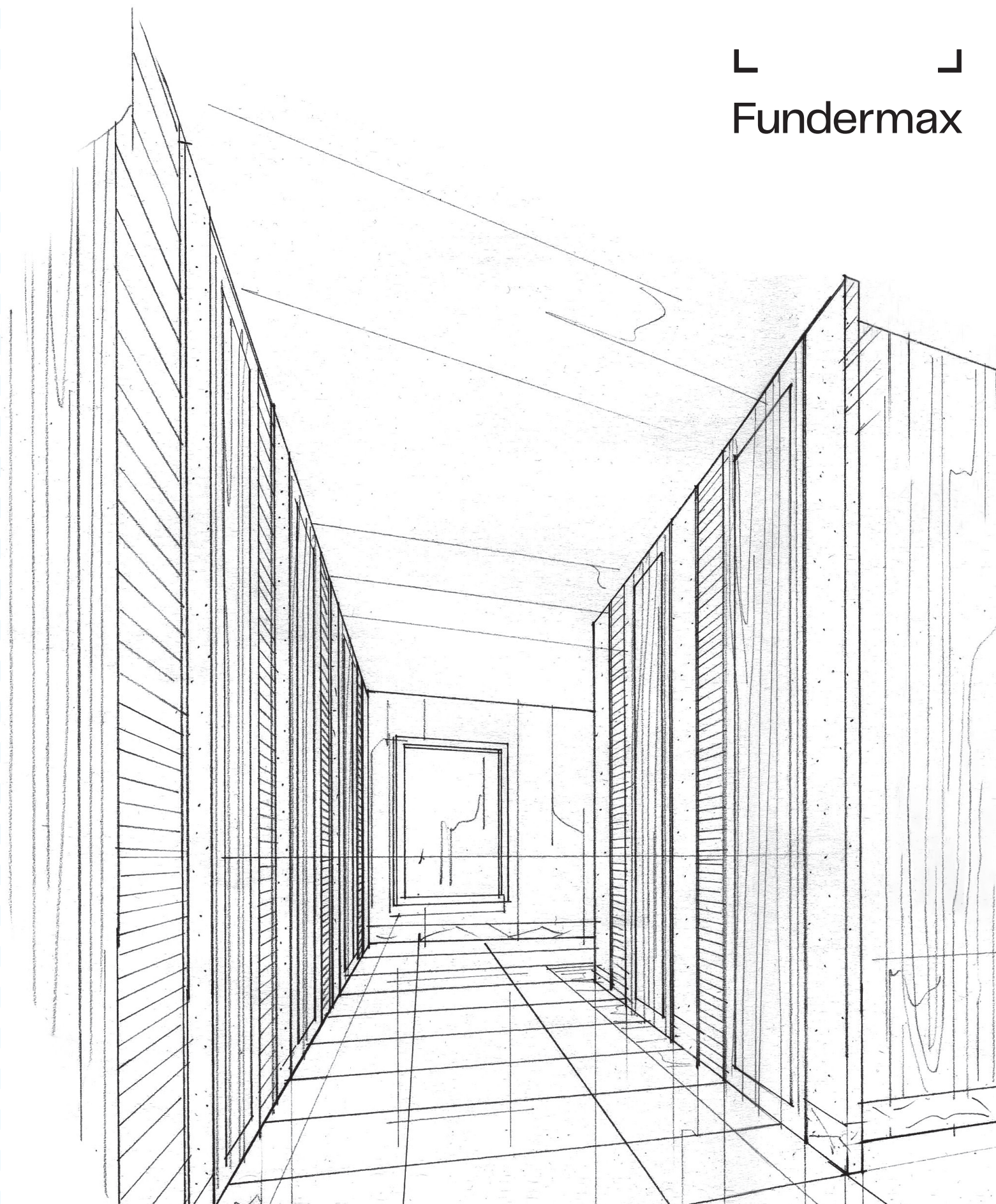

0124-V2_UK